

**Supplemental Specifications  
For the Construction of Public Infrastructure  
In the City of Minneapolis**

2021 Edition

Prepared by: City of Minneapolis Department of Public Works  
December 31, 2020

**Supplemental Specifications for the Construction of  
Public Infrastructure in the City of Minneapolis**

I hereby certify that the changes contained in these Supplemental Specifications for the Construction of Public Infrastructure in the City of Minneapolis, 2021 Edition, were prepared by me or under my direct supervision and that I am a duly registered professional engineer under the laws of the State of Minnesota.

Dated: 1/6/2021



Christopher D. DeDene, PhD, PE  
Materials Engineer  
Reg. No. 54211

# Supplemental Specifications for the Construction of Public Infrastructure in the City of Minneapolis

UPDATED: DATE

## INDEX

SECTION	ITEM DESCRIPTION	PAGE
DIVISION S - GENERAL SUPPLEMENTAL SPECIFICATIONS .....		1
S-1	EMERALD ASH BORER COMPLIANCE .....	1
S-2	ENVIRONMENTAL PROTECTION, INVASIVE SPECIES CONTROL.....	1
S-3	(1305) REQUIREMENT OF CONTRACT BOND .....	3
S-4	(1404) MAINTENANCE OF TRAFFIC, (1707) PUBLIC SAFETY .....	3
S-5	(1502) PLANS AND WORKING DRAWINGS .....	6
S-6	(1504) COORDINATION OF CONTRACT DOCUMENTS .....	7
S-7	(1507) UTILITY PROPERTY AND SERVICE .....	7
S-8	(1514) MAINTENANCE DURING CONSTRUCTION.....	9
S-9	(1515) CONTROL OF HAUL ROADS .....	10
S-10	(1702) PERMITS, LICENSES AND TAXES .....	10
S-11	(1710) TRAFFIC CONTROL DEVICES .....	12
S-12	(1717) AIR, LAND AND WATER POLLUTION.....	13
S-13	(1717) AIR, LAND AND WATER POLLUTION (CONCRETE GRINDING AND SAWING) .....	14
S-14	(1717) NATIONAL POLLUTANT DISCHARGE ELIMINATION SYSTEM (NPDES) PERMIT .....	15
S-15	(1803) PROGRESS SCHEDULES.....	18
S-16	(2104) REMOVE PAVEMENT & MISCELLANEOUS STRUCTURES .....	18
S-17	(2105) EXCAVATION AND EMBANKMENT .....	18
S-18	(2112) SUBGRADE PREPARATION.....	19
S-19	(2211) AGGREGATE BASE .....	20
S-20	(2301) CONCRETE PAVEMENT .....	20
S-21	(2356) BITUMINOUS SEAL COAT .....	22
S-22	(2360) PLANT MIXED ASPHALT PAVEMENT (SUPERPAVE) .....	24
S-23	(2461) STRUCTURAL CONCRETE .....	26
S-24	EXCAVATION AND PREPARATION OF TRENCH .....	26
S-25	(2502) SUBSURFACE DRAINS .....	37
S-26	(2503) PIPE SEWERS .....	38
S-27	(2506) MANHOLES AND CATCH BASINS .....	49

# Supplemental Specifications for the Construction of Public Infrastructure in the City of Minneapolis

S-28	(2511) RIPRAP .....	53
S-29	(2521) WALKS .....	53
S-30	(2564) TRAFFIC SIGNS & DEVICES.....	55
S-31	(2571) PLANT INSTALLATION AND ESTABLISHMENT .....	56
S-32	(2572) PROTECTION AND RESTORATION OF VEGETATION .....	56
S-33	(2573) STORM WATER MANAGEMENT .....	57
S-34	(2575) ESTABLISHING TURF AND CONTROLLING EROSION.....	58
S-35	(2582) PERMANENT PAVEMENT MARKING .....	58
S-36	(3138) AGGREGATE FOR SURFACE AND BASE COURSES.....	60
S-37	(3149) GRANULAR MATERIAL.....	60
S-38	(3861) PLANT STOCK.....	61
S-39	ROW TREE PLANTING .....	62
S-40	RECORD DRAWING REQUIREMENTS .....	63
S-41	UTILITY AGREEMENTS, PERMITS AND ORDERS.....	66
S-42	CONCRETE PAVED STREETS RESTORATION .....	66
S-43	MATERIALS TESTING REQUIREMENTS.....	68
<b>DIVISION SL - LIGHTING SUPPLEMENTAL SPECIFICATIONS .....</b>		<b>71</b>
SL-1	(2545) ELECTRICAL SYSTEM .....	71
SL-1.1	Scope of Work .....	71
SL-1.2	GENERAL.....	72
SL-1.3	Shop Drawings and Submittals.....	72
SL-1.4	Materials.....	73
SL-1.5	Construction Requirements .....	79
<b>DIVISION SS - SIGNALS SUPPLEMENTAL SPECIFICATIONS.....</b>		<b>88</b>
SS-1	(2565) TRAFFIC CONTROL SIGNALS .....	88
SS-1.1	General .....	89
SS-1.2	Materials.....	91
SS-1.3	Construction Requirements.....	114
SS-1.4	Removing, Salvaging, and Stockpiling Existing Materials and Electrical Equipment.....	150
SS-1.5	Type C and D Signs.....	153
SS-1.6	Traffic Signal Priority Control System .....	156
SS-1.7	Method of Measurement and Payment.....	172
SS-2	(2565) TRAFFIC CONTROL Interconnection .....	175

# Supplemental Specifications for the Construction of Public Infrastructure in the City of Minneapolis

SS-2.1 Electrical (Communications) System .....	175
SS-2.2 Method of Measurement and Payment.....	177
SS-3 (3815) Fiber Optic Cable .....	178
SS-3.1 Fiber Optic Cable and Testing.....	178
SS-3.2 Fiber Optic Hub Cabinet .....	189
SS-3.3 Fiber-Optic Hub Cabinet Foundation.....	198
SS-3.4 Fiber Optic Handholes and Installation .....	198
APPENDIX A - Asbestos Abatement.....	200
APPENDIX B – SAMPLE LOOP DETECTOR TEST REPORT .....	203
<b>DIVISION WM - WATER DISTRIBUTION SYSTEMS SUPPLEMENTAL SPECIFICATIONS</b>	<b>205</b>
SECTION 1000 GENERAL.....	205
PART 1 - GENERAL .....	205
PART 2 - PRODUCTS (NOT USED).....	207
PART 3 - EXECUTION (NOT USED).....	207
SECTION 2000 WATER UTILITY MATERIALS.....	207
PART 1 - GENERAL .....	207
PART 2 - PRODUCTS.....	209
PART 3 - EXECUTION (NOT USED).....	217
SECTION 3000 CONSTRUCTION.....	218
PART 1 - GENERAL .....	218
PART 2 - MATERIALS (NOT USED).....	218
PART 3 - EXECUTION.....	218
SECTION 0400 MEASUREMENT AND PAYMENT.....	233
PART 1 - GENERAL .....	233
PART 2 - PRODUCTS (NOT USED).....	233
PART 3 - EXECUTION.....	233
APPENDIX A - SAMPLE OF TRAFFIC CONTROL LOG .....	239
APPENDIX B - MPCA STORMWATER GUIDANCE.....	241

## DIVISION S - GENERAL SUPPLEMENTAL SPECIFICATIONS

### S-1 EMERALD ASH BORER COMPLIANCE

This Project is located, all or in part, in a county that the Minnesota Department of Agriculture has placed under an Emerald Ash Borer Quarantine. Any work for this Contract is subject to the following:

S-1.1 No part of an Ash (*Fraxinus* spp) tree from a quarantined area can be marketed to wood-using industries or individuals without an Emerald Ash Borer compliance agreement with Minnesota Department of Agriculture.

The Contractor shall not make ash or any non-coniferous (hardwood) species with bark attached available to the public for use as firewood from the quarantined area. The Contractor shall not transport entire ash trees, limbs, branches, logs, chips, ash lumber with bark, stumps and roots outside of a quarantined county without fulfilling the requirements of an Emerald Ash Borer Compliance Agreement with the Minnesota Department of Agriculture. Contact the Minnesota Department of Agriculture at 1-888-545-6684 or visit the Emerald Ash Borer website at: <http://www.mda.state.mn.us/plants/pestmanagement/eab.aspx> to find out which counties are quarantined.

S-1.2 If the ash material is going to be shipped out of Minnesota, the Contractor shall contact [John.o.haanstad@aphis.usda.gov](mailto:John.o.haanstad@aphis.usda.gov) for United States Department of Agriculture joint Emerald Ash Borer Compliance Agreement approval with the Minnesota Department of Agriculture.

S-1.3 The Contractor shall dispose of ash trees:

- (1) In accordance with the Emerald Ash Borer Compliance Agreement, and
- (2) By utilizing the ash wood chips within the construction limits for erosion control, construction exit pads or landscaping purposes.

S-1.4 No direct compensation will be made for compliance with these requirements.

### S-2 ENVIRONMENTAL PROTECTION, INVASIVE SPECIES CONTROL

#### A. AQUATIC INVASIVE SPECIES CONTROL

The Mississippi River and its backwaters are designated as infested by both Wisconsin and Minnesota. Aquatic Invasive Species (AIS) such as zebra mussels, purple loosestrife, Eurasian water milfoil, and Viral Hemorrhagic Septicemia (VHS) are known to be in the area. These pose adverse effects to waters of both Wisconsin and Minnesota. Wisconsin State Statutes 30.07, and Minnesota Statutes 84D.09 details the state laws that prohibit transport of aquatic plants, zebra mussels or other prohibited species. All equipment must be clean prior to arriving on site, and again cleaned prior to leaving the site.

In the State of Minnesota water from infested waters may not be transported on a public road or off riparian property on infested waters except in emergencies or under permit: [http://files.dnr.state.mn.us/waters/forms/permit\\_approp\\_inf.doc](http://files.dnr.state.mn.us/waters/forms/permit_approp_inf.doc)

DNR General Permit to MnDOT (GP 2004-0001) authorizes work in infested waters, though requires that all equipment (such as machinery, pumps, hoses, sheetpile, sediment control materials, excess riprap from in-water fill pads, etc) that have been in contact with waters that are designated as infested waters, shall be inspected by MnDOT or its contractors and adequately decontaminated prior to being transported off site. The MnDNR is available to MnDOT site inspectors and may be able to assist in these inspections.

Wisconsin requires that at construction sites that involve navigable water or wetlands, use cleaning procedures to minimize the chance of spreading exotic invasive species infestation. Procedures must be in place for all equipment that has been in contact with waters of the state and/or infested water or potentially infested water to be clean prior to coming into the site and again prior to leaving the site.

Therefore, the contractor shall ensure that all equipment that has previously been in contact with waters of the state (Minnesota and/or Wisconsin), or with infested or potentially infested waters anywhere (other states or countries), has been decontaminated for aquatic plant materials and zebra mussels and other prohibited invasive species prior to being brought on to the project site or leaving the project site. Use the following inspection and removal procedures (guidelines from the Wisconsin Department of Natural Resources: [http://dnr.wi.gov/fish/documents/disinfection\\_protocols.pdf](http://dnr.wi.gov/fish/documents/disinfection_protocols.pdf)) for disinfection:

1. Prior to leaving the site, wash machinery and ensure that the machinery is free of all soil, mud, plants, seeds and other substances that could possibly contain aquatic invasive species;
2. Drain all water from boats, barges, trailers, bilges, pumps, hoses, silt curtain, live wells, coolers, buckets, engine compartments, and any other area where water may be trapped;
3. Inspect boat hulls, propellers, trailers and other surfaces. Scrape off any attached mussels and other prohibited invasive species, remove any aquatic plant materials (fragments, stems, leaves, seeds, or roots), and dispose of removed mussels and plant materials in refuse containers or other suitable containment procedure prior to leaving the area or invested waters; and
4. Disinfect boats, barges, equipment and gear that has been in contact with the water by either:
  - a. Washing with ~212° F water (steam clean), or
  - b. Drying thoroughly for seven (7) days after cleaning with soap and water and/or high-pressure water, or
  - c. Disinfecting with either 200 ppm (0.5 oz. per gallon or 1 Tablespoon per gallon) Chlorine for 10-minute contact time or 1:100 solution (38 grams per gallon) of Virkon Aquatic for 20- to 30-minute contact time. Note: Virkon is not registered to kill zebra mussel veligers nor invertebrates like spiny water

flea. Therefore this disinfect should be used in conjunction with a hot water (>104° F) application, or.

- d. If upon visual inspection and removal any plant or animal material, twenty-one (21) days of complete drying.

Note: Complete inspection and removal procedures shall occur before equipment is brought to the project site and before the equipment leaves the project site.

**B. UPLAND INVASIVE SPECIES CONTROL**

In order to avoid spreading upland invasive species outside of the project site, establish staging areas for storing equipment and materials at the boat landing parking lot or on the paved roadway. Apply the same cleaning protocol as established to remove aquatic invasive species (see Part A, Aquatic Species Control).

Prior to leaving the project site, wash machinery and boots to ensure that they are free of all soil and other substances that could possibly contain invasive species.

Complete the inspection and removal procedure before the equipment leaves the project site.

**C. MEASUREMENT AND PAYMENT**

No measurement or payment shall be made for controlling aquatic or upland invasive species.

**S-3 (1305) REQUIREMENT OF CONTRACT BOND**

For the purpose of these Supplemental Provisions MnDOT 1305 shall govern, except with the following modifications and amendment(s):

**For SIDEWALK PERMITS ONLY**

The contractor shall furnish and present insurance documentation satisfactory to the City Engineer as is required by the City ordinance for all persons performing work on the public sidewalks, among other things indemnifying the City against all claims for damages arising by reason of negligence of the contractor in the construction of the sidewalk, or from obstruction of the streets or from any other cause, and guaranteeing to maintain their work free from defects for a period of two (2) years, all as provided in Ordinance 437.30 of the City of Minneapolis passed January 28, 1898, as amended.

**For all other bonds, Minneapolis Code of Ordinance 429 applies**

**S-4 (1404) MAINTENANCE OF TRAFFIC, (1707) PUBLIC SAFETY**

The provisions of 1404 are supplemented as follows:

The Contractor shall furnish, install, maintain, and remove all traffic control devices required to provide safe movement of vehicular and/or pedestrian traffic passing through the work zone



during the life of the Contract from the start of Contract to the final completion thereof. The Engineer will have the right to modify the requirements for traffic control as deemed necessary due to existing field conditions.

Traffic control devices include, but are not limited to, concrete barriers, barricades, warning signs, advance warning signs, trailers, flashers, cones, drums, pavement markings and flaggers as required and sufficient barricade weights to maintain barricade stability.

Pedestrian Access During Construction:

The Contractor shall note that long-term closures of any corner of an intersection to pedestrians will not be allowed on this project. With regards to the requirement, the Contractor shall note the following:

-The Contractor must maintain pedestrian access on all corners of each intersection at all times unless specifically approved by the Engineer and the City.

-The Contractor shall provide sufficient secure temporary ramps for pedestrian and wheelchair access where existing pedestrian curb ramps are closed and pedestrian traffic is diverted around the work on a corner of an intersection.

-The Contractor shall provide, install, maintain, relocate, and remove all required concrete barrier around the corner of an intersection under sidewalk and signal construction to protect both pedestrians and the work during construction. Concrete barrier shall be provided on both the work side and the traffic side on each corner to sufficiently protect pedestrians during construction. At least a 5-foot wide level walkway must be maintained on each corner during construction at all times unless otherwise specifically approved in the field by the Engineer and the City of Minneapolis.

-Temporary adjacent traffic lane and parking lane closures may be allowed as approved by the Engineer to facilitate construction and equipment placement during construction. For any lane closures approved by the Engineer, the Contractor is required to provide, install, maintain, and remove all appropriate traffic control devices (cones, barricades, barrels, signs, etc.), all in accordance with the Field Manual.

-Pedestrian access to any doors for local residences and businesses in the area of construction must be maintained at all times unless otherwise approved by the Engineer and the City of Minneapolis.

-“Sidewalk Closed” signing and diverting of pedestrian traffic to another corner of the intersection during construction will not be allowed unless otherwise specifically approved in the field by the Engineer and the City of Minneapolis.

Bus Passenger Waiting Shelters:

If a bus passenger waiting shelter will be disturbed, the contractor shall notify both the owner of the shelter and the City of Minneapolis Public Works Traffic and Parking Services Division (Traffic and Parking Services) (612) 673-5759.

Two types of bus passenger waiting shelters exist on the right-of-way in Minneapolis. CBS Outdoor (612) 919-5923 owns bus shelters with advertising panels. Bus shelters without advertising are owned by Metro Transit (612) 349-7310.

At least ten days advance notice to Traffic and Parking Services and the owner of the shelter is required if a shelter is to be moved.

When the sidewalk is to be replaced under a shelter, there should be no expansion joints in the sidewalk under the shelter whenever possible. All CBS Outdoor bus shelters and most Metro Transit bus shelters are connected to an electrical service point by buried conduit. The service point may be a City ornamental street light, an Excel Energy service point, or a private third-party source. The owner of the shelter will inform the City of the location of this conduit when requested. The cost for repairing or replacing damaged conduit shall be charged to the contractor and/or the property owner.

City Code provides that if a CBS Outdoor shelter must be temporarily removed for construction done by the City of Minneapolis or its contractor, then CBS Outdoor shall, at its own cost, remove the shelter when requested to do so by the City Engineer. The City may also order CBS Outdoor to temporarily remove a shelter for an abutting property owner's construction at the property owner's expense.

Protection of the Work Site:

The contractor shall erect and continuously maintain barricades to protect each job site immediately upon removal of the existing concrete. In a location where section(s) of the public sidewalk have been removed, two barricades will be required, one on each end of each work location. The number and placement of barricades required will be subject to the approval of the City Sidewalk Inspector, and may also be subject to the approval of the City Lane Use Administrator, (612) 673-2383.

Mid-block Pedestrian Ramps:

The Traffic and Parking Services Division, 300 Border Ave S, phone (612) 673-5750, and the Sidewalk Inspections office located at 1901 E 26th Street, phone (612) 673-2420, must approve plans for any new construction of a mid-block pedestrian ramp. The plan should show the following items:

- The location of the ramp in relation to the address of the requesting party.
- The property lines of the requesting party's property should be shown.
- The ramp should be designed in accordance with the Supplemental Provisions.

In addition, the following concerns will be evaluated regarding each ramp request: The proximity of trees, hydrants, or driveways, the type of boulevard, the type of dwelling unit, any

impact on the sidewalk, any existing parking restrictions or zones, and the presence of parking meters, electrical conduit, and other infrastructure or obstructions.

The plan shall be accompanied by a written statement by the requesting party describing the nature of the request and a signed statement acknowledging that the placement of the ramp does not grant any exclusive rights to the requesting party for the use of the curb space or the ramp.

The establishment of a Handicap Transfer Zone or Handicap Parking Zone along the curb adjacent to the proposed ramp is not required but may be desirable. Contact the Traffic and Parking Services Division (612)-673-5750, at 300 Border Ave S, for details.

After the City Traffic and Parking Services Division grants its approval, your plans must be submitted to the Public Works Sidewalk Inspections office, 1901 E 26th St., phone (612) 673-2420, for a "Sidewalk Construction Permit". Contractors who have submitted a bond, kept on file with the City Public Works Sidewalk Inspections office, are eligible to obtain the Sidewalk Construction Permit.

#### Drive Approaches:

No driveway approach shall be installed without first submitting plans. If a new drive Approach is to be installed on a street other than a trunk highway, four (4) copies of the plan, of Engineering quality, in a minimum size of 8 ½ inches by 11 inches, and at a scale of 1/32 inch per foot, or 20, 30, or 50 foot per inch, showing complete details of the drive approach and driveway layout, shall first be submitted to the Development Review Coordinator, Minneapolis One Stop, Room 300, 250 South Forth Street, Minneapolis, MN, 55415-1335, (612) 673-5867, for approval. Plans must be submitted three to four weeks in advance of the actual start of construction so that the plans can be reviewed by Zoning and by Public Works staff.

**See Minneapolis Department of Public Works Standard Plate Number ROAD- 2000 for driveway approach dimension requirements.**

#### Measurement and Payment:

No measurement will be made of the various Items that constitute Traffic Control but all such work will be construed to be included in the single Lump Sum payment under Item 2563.601 (Traffic Control).

#### **S-5 (1502) PLANS AND WORKING DRAWINGS**

If shop drawings are required, the Contractor shall coordinate all such drawings, and review them for accuracy, completeness, and compliance with contract requirements and shall indicate it's approval thereon as evidence of such coordination and review. The Contractor shall identify in writing all changes, deviations or substitutions from the requirements of the contract documents. The review of any Contractor submittal is not deemed to authorize changes or substitutions from the requirements of the contract documents unless the Engineer specifically

authorizes the change or substitution. The review without exception by the Engineer shall not relieve the Contractor from responsibility for any errors or omissions in such drawings.

### **S-6 (1504) COORDINATION OF CONTRACT DOCUMENTS**

The State of Minnesota, Department of Transportation "Standard Specifications for Construction", 2018 edition, shall govern, except where modified or amended by other contract documents and applicable City Code. All reference to other Specifications of AASHTO, ASTM, ANSI, AWWA, etc. shall mean the latest published edition available on the date of advertisement for bids. City of Minneapolis, Public Works Standard Plates are hereby incorporated into these Supplemental Specifications. The Standard Plates and this Supplemental Specifications for Construction of Public Infrastructure are available at the following web address:

<http://www.ci.minneapolis.mn.us/publicworks/plates/index.htm>

#### Definitions/Order of Precedence

For the purpose of these Supplemental Specifications the following terms shall have these definitions: "City" means the City of Minneapolis, Minnesota. "City Engineer" means the City Engineer of the City of Minneapolis or any other designated representative. The order of precedence for work performed under these supplemental specifications shall be:

1. The City of Minneapolis Code of Ordinances (City Code).
2. Addenda
3. Special Provisions
4. Project-Specific Plan Sheets
5. The Supplemental Specifications for Construction of Public Infrastructure in the City of Minneapolis
6. City of Minneapolis, Public Works Standard Plates
7. MnDOT Standard Plan Sheets and Standard Plates
8. The State of Minnesota, Department of Transportation "Standard Specifications for Construction", 2018 edition

### **S-7 (1507) UTILITY PROPERTY AND SERVICE**

Work near utilities shall be in accordance with the provisions of 1507 and the following:

The Plan contains information relative to the location of existing utilities to the extent this information is available from the respective utility owners. The City does not guarantee the locations as shown in the Plan. It shall be the Contractor's responsibility to contact Gopher State One Call and to ascertain the actual location of these utilities prior to commencing construction. The Contractor shall be solely responsible for verifying the exact location of each of these facilities.

It will be the Contractor's responsibility to contact the owners of all utilities in any area prior to the construction in the area so that he can be informed of the exact locations of all the utilities in the area including any that are not shown in the plans. It will also be the Contractor's

responsibility to: (1) report any existing damage or faulty condition (i.e. sand in manholes, damaged valve boxes, etc.) to the owners prior to construction, as once excavation has commenced it will be assumed that all damage to underground installations has been caused by the Contractor's operations and it will be its responsibility to make the necessary repairs; and (2) upon completion of the project, contact all utility owners and make arrangements for a field inspection trip by a representative of the Contractor and representatives of the utility owners to confirm that all damages caused by the Contractor's operations have been repaired to the satisfaction of the owners.

The City shall not be held responsible for any delay that the Contractor may encounter by reason of the utility company involved failing to promptly do their necessary work. It shall be the Contractor's responsibility to meet with the affected utility companies as soon as possible to coordinate timely relocations. It shall be the Contractor's responsibility to coordinate work with the utility companies to accomplish utility relocations and to preserve the existing condition of any utilities to remain in their current location. Additionally, the Contractor shall provide for the continuance of service of such utilities where such service may be disrupted as a result of the Contractor's operations. It shall be the Contractor's responsibility to ensure all excavations are thoroughly backfilled and compacted according to these specifications to prevent any displacement or settlement of the utility facility. No deviation from the approved line or grade of any proposed City work (sewer, storm drain or water main, pavement, etc.) due to conflicts with existing utilities shall be made without first obtaining the written consent of the City Engineer. The Contractor shall employ special equipment or construction methods, and hand labor if necessary, to accomplish the planned work adjacent to utility facilities without damaging them. No additional compensation will be made for performing planned work around adjacent utility facilities.

Any utilities to be abandoned by the utility owners shall be removed by the Contractor in accordance with MnDOT standard specification 2104 and S-16 of these Standard Supplemental Specifications. The removal of portions of abandoned utility lines and pipes when required for the new construction will be incidental work for which no direct compensation will be made.

All projects constructing or altering public infrastructure shall provide record drawings to the City in accordance with Section S-40 of these provisions.

No sewer or storm drain work performed on private connections shall commence before an extension permit or connection permit has been applied for and approved by the Utility Connections Department. The contractor shall comply with all terms of the permit.

When working on any part of an existing sanitary or storm system, every effort shall be made to prevent construction debris from entering into the system. If construction debris does enter into the sewer system it must be removed immediately, or as soon as is reasonably possible. If the construction debris enters the system under flow, or flow occurs before the construction debris is removed, all affected infrastructure shall be cleaned and the construction debris removed, including infrastructure outside of the project area.

The Contractor shall notify the Maintenance Supervisor of SWS Operations Office 48 hours prior to inspecting, accessing, or working on any part of the SWS Sewer or Storm Drain system. The contact telephone number for the Maintenance Supervisor is (612) 673-5625.

All work on City sewer and storm drain system shall be inspected by a designated representative of SWS. Until the contractor receives written notice from SWS of acceptance of the work covered by approved plans, the Contractor will be responsible for any sewer or storm drain related problems. All laboratory tests shall be submitted to SWS and approved prior to restoration of the work area subject to testing. SWS Operations will determine the need to have representatives on site to observe utility testing.

All design changes and all field modifications that change pipe clearance or change the size, grade or alignment of an SWS sewer or storm drain shall be approved by SWS prior to commencing work on those changes. All design changes shall be submitted 72 hours before work is to commence

#### **S-8 (1514) MAINTENANCE DURING CONSTRUCTION**

The requirement to maintain the Project Roadway is extended to include all roadway, sidewalk, and bike path affected by the project. All temporary work necessary to maintain the roadway/sidewalk/bike path open for traffic shall be considered incidental to the contract with no direct compensation made therefore.

The Contractor's requirements for sweeping as required under MnDOT 2051 shall mean that the City Engineer may require additional street sweeping of the Haul Roads and the roads adjacent to the construction site to provide safe conditions for the traveling public, to prevent environmental damage, or to comply with local regulatory requirements. See Appendix B-10 for additional guidance on vehicle tracking Best Management Practices (BMPs). The Contractor shall maintain drainage for all temporary roadways and work sites at all times. When existing drainage facilities are severed or otherwise rendered inoperable, the Contractor shall construct as much of the designed drainage system as may be necessary to maintain adequate drainage. Temporary grading and/or ditching may also be required to maintain drainage. Any temporary grading and ditching that is required shall be completed as an incidental expense unless it is part of the designed project earthwork. All temporary drainage work shall be completed to the satisfaction of the Engineer. All side slopes adjacent to temporary bypasses shall be effectively maintained against erosion and stabilized within 7 days after the end of active work. In the event erosion occurs, the Contractor shall reshape the slope to its original elevations and cross section in accordance with Article 52 of City Code. The side slope maintenance is required to ensure the integrity and traffic carrying ability of the adjacent temporary bypass.

The Contractor shall comply with Erosion Control Specifications and/or with the Erosion Control Plan. That compliance does not relieve the Contractor from their responsibility for cleaning the sewer system should any soil be washed into it.

**S-9 (1515) CONTROL OF HAUL ROADS**

If the Contractor's use of City roads, other than the roads agreed to by the City, result in damage or decrease in the recorded Pavement Condition Index, it shall be the Contractor's responsibility to provide restitution to the City for repairs or replacement of the roads. Repairs will be determined based on Minneapolis Code of Ordinances 429 and 430.

**S-10 (1702) PERMITS, LICENSES AND TAXES**

For the purpose of these Standard Supplemental Specifications MnDOT 1702 shall govern, except with the following modifications and amendment(s):

A "Sidewalk Construction Permit" shall be obtained for each and every job done in the City of Minneapolis public right of way. All permits must be obtained before any demolition or actual construction work begins. Each job will consist of the work done adjacent to a single property, unless other arrangements are made with the Sidewalk Inspections Office. Application for the Sidewalk Construction Permit shall be submitted by the Contractor online at:

[www.sidewalk.mpls.mn.roway.net](http://www.sidewalk.mpls.mn.roway.net)

The City Code pertaining to Sidewalk Construction Permit fees reads as follows:

*"437.20. Permit required fees. No person shall construct any sidewalk, curb, curb and gutter, or other pavement within the public right of way without first obtaining a permit from the city engineer and paying a permit fee of ten (10) percent, based upon the value of the work as established annually by the district sidewalk contractor's accepted bid prices and by the City of Minneapolis unit prices list for such work"*

All work within the public right of way must be done by a contractor under the supervision of the City Engineer, or their designated representative, who will see that these Standard Supplemental Specifications are rigidly followed. Prior to the issuing a sidewalk permit, the contractor shall have on file the proper insurance as stated in other sections of these specifications.

Beginning in January 2021 all contractors installing ADA compliant pedestrian ramps in the public right of way must have their current MnDOT ADA Certification Card on file with certification number with the City of Minneapolis Sidewalk Department. The address of the Sidewalk Department can be found in other sections of these specifications. Contractors installing ADA Pedestrian Ramps without this card on file will be considered unacceptable and must be immediately corrected.

The Sidewalk Inspector is to be notified at least three (3) days in advance of any construction. The Sidewalks Inspector's name and telephone number appear on the Contractor's copy of the Sidewalk Construction Permit.

Please make all checks payable to: City of Minneapolis Finance Department Sidewalk Construction Permits as issued by the Sidewalk Inspections office will be in the contractor's

possession, on site, while the work is being performed. Any City licenses and permits required to perform electrical, sewer or water work on this project shall be obtained from the appropriate City of Minneapolis office by the Contractor at its cost.

**MPRB FORESTRY TREE REMOVAL, PRUNING, OR PLANTING PERMITS**

A permit is required to remove, prune, or plant a tree on any City owned property. Tree removal, pruning, and planting approved by MPRB Forestry through formal City Review (Preliminary Development Review or Capital Projects Task Force review) shall constitute compliance.

Application for tree removal, pruning, and planting permits for all other projects shall be requested by contacting:

MPRB Forestry  
3800 Bryant Ave S.,  
Minneapolis, MN 55409  
(612)-499-9233

All tree work within the public right of way must be done by a Minneapolis Licensed Tree Contractor. The Inspections office maintains a listing of all contractors who are properly licensed. To obtain a list of Minneapolis Licensed Tree Contractors call 311 or visit <http://www.minneapolismn/licensing/treeservicecontractors>

The City Code pertaining to Tree removal and pruning reads as follows:

PB10-9. - Damaging trees

No person shall remove, destroy, cut, deface, trim or in any way injure or interfere with any tree or shrub on any of the avenues, streets or public grounds, including parks and parkways, without a permit from the general superintendent of parks. (Code 1960, As Amend., § 1020.090)

**OBSTRUCTION PERMIT**

From City Transportation Division  
300 Border Avenue North  
Telephone # (612) 673-2383

An obstruction permit is needed for any use of or closure of any lanes such as sidewalk, parking lane, bike lane, alley, traffic lane, bus lane, or road closure. Use the following link to obtain an obstruction permit.

<https://minneapolis.mn.roway.net>

**EXCAVATION, UTILITY CONNECTION & EROSION CONTROL PERMITS**

Public Health Center, Room 222  
250 South 4th Street  
Telephone # (612) 673-2451

**WATER DEPARTMENT FIRE HYDRANT PERMIT**

Hydrant taps can be obtained and water purchased at residential rates at hydrants designated by the City. Hydrant Permits are available through the City of Minneapolis Water Department



Telephone # (612)-673-2865

AFTER HOURS WORK PERMIT AND/OR NOISE PERMIT

Available from the City of  
Minneapolis, Inspections Department  
Telephone # (612) 673-2635

or visit:

[http://www.minneapolismn.gov/publicworks/permits/public-works\\_pw-construction-permits](http://www.minneapolismn.gov/publicworks/permits/public-works_pw-construction-permits)

**The City of Minneapolis reserves the right to withhold the issuing of any future permits to any Contractor until any current problems or failures to meet these special provisions are resolved, to the satisfaction of all parties.**

**S-11 (1710) TRAFFIC CONTROL DEVICES**

When existing pedestrian facilities are disrupted, closed, or relocated in a Temporary Traffic Control zone, the temporary facilities shall be detectable and include accessibility features consistent with the features present in the existing pedestrian facility.

All temporary metal orange warning signs shall be fabricated with Type DGC (Diamond Grade Cubed) sheeting and metal orange regulatory guide signs shall be fabricated with Type HIP (High Intensity Prismatic) Sheeting.

Long term traffic control devices shall be inspected on a daily basis and maintained for the duration of use. Inspections of the traffic control devices shall be documented and presented to the City of Minneapolis upon request. Appendix A contains a sample of the traffic control log

*Section 1710 is hereby supplemented to include the following:*

Traffic control devices shall be provided in accordance with the provisions of 1710 and the latest edition of the Minnesota Manual on Uniform Traffic Control Devices (MN MUTCD) and Part IV, Field Manual for Temporary Traffic Control Zone Layouts, except as modified as herein:

*The first paragraph of 1710.2 is revised to read as follows:*

The Contractor shall furnish, install, maintain and remove all traffic control devices in accordance with these Standard Supplemental Specifications and the Minnesota Manual on Uniform Traffic Control Devices (MN MUTCD) - including the Field Manual for "Temporary Traffic Control Zone Layouts", latest edition. The Engineer will have the right to modify the requirements for traffic control as deemed necessary due to existing field conditions. The Contractor's responsibilities under this section include, but are not limited to, the following:

*Subparagraph (2) of the first paragraph of 1710.2 is revised to read as follows:*

(2) To control and guide traffic through the project and over any temporary bypasses.

*The provisions of 1710.5 including all supplements thereto are hereby deleted from the Contract.*

## **S-12 (1717) AIR, LAND AND WATER POLLUTION**

### **A. Discovery of contaminated materials and regulated wastes**

If during the course of the Project, the Contractor unexpectedly encounters any of the following conditions indicating the possible presence of contaminated soil, contaminated water, or regulated waste, the Contractor shall immediately stop work in the vicinity and request suspension of work in the vicinity of the discovery area, in accordance with MnDOT 1803.6.

A documented inspection and evaluation will be conducted prior to the resumption of work. The Contractor shall not resume work in the suspected area without authorization by the Engineer. The Contractor shall adhere to all laws and regulations as they relate to excavating, stockpiling, hauling and disposing of contaminated materials.

### **B. Indicators of contaminated soil, ground water or surface water include, but are not limited to the following:**

- (1) Odor including gasoline, diesel, creosote (odor of railroad ties), mothballs, or other chemical odor.
- (2) Soil stained green or black (but not because of organic content), or with a dark, oily appearance, or any unusual soil color or texture.
- (3) A rainbow color (sheen) on surface water or soil.

### **C. Indicators of regulated wastes include, but are not limited to the following:**

- (1) Cans, bottles, glass, scrap metal, wood (indicators of solid waste and a possible dump)
- (2) Concrete and asphalt rubble (indicators of demolition waste).
- (3) Roofing materials, shingles, siding, vermiculite, floor tiles, transite or any fibrous material (indicators of demolition waste that could contain asbestos, lead or other chemicals).
- (4) Culverts or other pipes with tar-like coating, insulation or transite (indicators of asbestos).
- (5) Ash (ash from burning of regulated materials may contain lead, asbestos or other chemicals).
- (6) Sandblast residue (could contain lead).
- (7) Treated wood including, but not limited to products referred to as green treat, brown treat and creosote (treated wood disposal is regulated).
- (8) Chemical containers such as storage tanks, drums, filters and other containers (possible sources of chemical contaminants).
- (9) Old basements with intact floor tiles or insulation (could contain asbestos), sumps (could contain chemical waste), waste traps (could contain oily wastes) and cesspools (could contain chemical or oily wastes).

**The Contractor is reminded that if they suspect that they have encountered contaminated soil, water or regulated waste that they should contact the State Duty Officer immediately at 1-800-422-0798 or 1-651-649-5451 and shall also notify the City of Minneapolis Superintendent of Environmental Engineering at 612-673-2456.**

**S-13 (1717) AIR, LAND AND WATER POLLUTION (CONCRETE GRINDING AND SAWING)**

*Supplement MnDOT Section 1717 with the following:*

**DIAMOND SURFACING, CONCRETE SAWING and BITUMINOUS SAWING**

Residue and excess water resulting from this operation shall be removed from the roadway by a continuous vacuum and collection system. Residue and water shall not be permitted to flow across adjacent traffic lanes, onto shoulders, off bridge decks, into gutters, or enter closed drainage systems. The Contractor is responsible for providing a suitable means to manage the grinding residue.

In urbanized areas with closed drainage systems, the slurry shall be collected and transported to a lined containment pond constructed by the contractor. To ensure a spill does not occur during transport the slurry should be collected in water-tight haul units. The containment ponds may be constructed within or outside the right-of-way. The contractor must submit a slurry management plan along with written assurance of proper handling during all phases of transport and disposal at the preconstruction conference or at least 30 days prior to diamond grinding for approval by the Engineer. Areas outside of the Right-of-Way may require a separate NPDES construction storm water permit.

At a minimum, the slurry management plan must include the following information for any proposal that will use a containment pond (pit):

- Provide an estimate of the volume of slurry that will be produced on the project and the volume of the containment pond (pit).
- Ownership and location of the containment pond.
- The plan must address if the pond will be lined with clay (including thickness of clay layer) or if an impermeable membrane will be used (including thickness of membrane).
- Describe how the water will be managed. Examples: Will the water be allowed to evaporate or once the fines have settled will the containment pond be dewatered and the water reused in the grinding operation, slurry broadcast operation, used in a commercially useful manor (i.e. dust control, grade compaction), or sent via sanitary sewer or hauled to a water treatment facility? \*If disposing at a treatment facility, the name of the treating facility must be provided.
- Describe how the solids (fines) will be managed. Examples: Will the solids be used as a fill material, a component in recycled aggregate or any other commercially useful application, transported to a facility where they can be stored for future, or disposed of in a landfill? The Contractor shall furnish the Engineer with a document that identifies the name and location of the reuse storage facility or a MPCA permitted lined mixed municipal solid waste or industrial landfill that the solids will be deposited.

**S-14 (1717) NATIONAL POLLUTANT DISCHARGE ELIMINATION SYSTEM (NPDES)  
PERMIT**

- Any proposed reuse of water or solids must be fully described in the plan. Solids reuse must include a description of the engineering need for the material. The pond area shall be reclaimed to its original condition and vegetated as appropriate to protect against erosion.

**S-14 (1717) NATIONAL POLLUTANT DISCHARGE ELIMINATION SYSTEM (NPDES)  
PERMIT**

Pollution of natural resources of air, land and water by operations under this Contract shall be prevented, controlled, and abated in accordance with the rules, regulations, and standards adopted and established by the Minnesota Pollution Control Agency (MPCA), and in accordance with the provisions of MnDOT 1717, these Special Provisions, and the following:

The Contractor is a co-permittee with the City to ensure compliance with the terms and conditions of the General Storm Water Permit (MN R100001) and is responsible for those portions of the permit where the operator is referenced. A copy of the "General Permit Authorization to Discharge Storm Water Associated with a Construction Activity under the National Pollutant Discharge Elimination System (NPDES)/State Disposal System Permit Program" is available at:

<http://www.pca.state.mn.us/water/stormwater/stormwater-c.html>

The Contractor shall apply and pay for the NPDES Permit on this Project. The Contractor shall complete the application process, and post the Permit and MPCA's letter of coverage onsite. Some work in waters of the state may require additional permits from the Minnesota Department of Natural Resources and may require additional permits from the U.S. Army Corps of Engineers or local watershed management organizations even if not required in these specifications.

No work which disturbs soil and/or work in waters of the state will be allowed on this Project until the NPDES Permit is in effect and the Department has received the required documentation.

The Contractor shall be solely responsible for complying with the requirements listed in Part II.B and Part IV of the General Permit.

The Contractor shall be responsible for providing all inspections, documentation, record keeping, maintenance, remedial actions, and repairs required by the permit. All inspections, maintenance, and records required in the General Permit Paragraphs IV.E, shall be the sole responsibility of the Contractor. The word "Permittee" in these referenced paragraphs shall mean "Contractor". Standard forms for logging all required inspection and maintenance activities shall be used by the Contractor. All inspection and maintenance forms used on this Project shall be turned over to the Engineer every two weeks for retention in accordance with the permit. The Contractor shall have all logs, documentation, inspection reports on site for the Engineer's review and shall post the permit and MPCA's letter of coverage on site. The Contractor shall immediately rectify any shortcomings noted by the Engineer. All meetings with the MPCA, Watershed Management Organization (WMO), or any local authority related to General Permit compliance shall be

**S-14 (1717) NATIONAL POLLUTANT DISCHARGE ELIMINATION SYSTEM (NPDES)  
PERMIT**

attended by both the Engineer and the Contractor. No work required by regulatory agencies, for which the Contractor would request additional compensation, shall be started without proper approval from the Engineer. No work required by regulatory agencies, where the changes will impact the design or requirements of the Contract documents or impact traffic shall be started without proper approval from the Engineer.

The Contractor shall immediately notify the Engineer of any site visits by Local Permitting Authorities performed in accordance with Part V.H.

Emergency Best Management Practices must be enacted to help minimize turbidity of surface waters and relieve runoff from extreme weather events. It is required to notify the MPCA Regional Contact Person within 2 days of an uncontrolled storm water release. The names and phone numbers of the MPCA Regional Contract personnel can be found at: <http://www.pca.state.mn.us/water/stormwater/stormwater-c.html>. The Contractor is reminded that during emergency situations involving uncontrolled storm water releases that the State Duty Officer must be contacted immediately at 1-800-422-0798 or 1-651-649-5451.

The Contractor shall review and abide by the instructions contained in the permit package. The Contractor shall hold the City harmless for any fines or sanctions caused by the Contractor's actions or inactions regarding compliance with the permit or erosion control provisions of the Contract Documents.

The Contractor is advised that Section 1 of the NPDES application form makes reference to a Storm Water Pollution Prevention Plan (SWPPP). This Projects' SWPPP is addressed throughout MnDOT's Standard Specifications for Construction, as well as this Project's Plan and these Special Provisions. The following table identifies NPDES permit requirements and cross-references where this Contract addresses each requirement.

<b>NPDES Permit Requirements</b>	<b>Cross-Reference within this Contract</b>
Obtain NPDES Permit; Permit Compliance; Submit Notice of Termination	MnDOT 1701, 1702; Special Provisions: 1717 (Air, Land & Water Pollution), 1717 (National Pollutant Discharge Elimination System (NPDES) Permit)
Certified Personnel in Erosion / Sediment Control Site Management Develop a Chain of Command	MnDOT 1506; Special Provisions: 1717 (Air, Land & Water Pollution), 1717 (National Pollutant Discharge Elimination System (NPDES) Permit); and 2573 (Erosion Control Supervisor).
Project / Weekly Schedule (for Erosion / Sediment Control) Completing Inspection / Maintenance Log / Records	Special Provisions: 1717 (Air, Land & Water Pollution), 1717 (National Pollutant Discharge Elimination System (NPDES) Permit); and 2573 (Erosion Control Supervisor)

**S-14 (1717) NATIONAL POLLUTANT DISCHARGE ELIMINATION SYSTEM (NPDES)  
PERMIT**

Project Specific Construction Staging	The Plans; Special Provisions: 1717 (Air, Land & Water Pollution), 1717 (National Pollutant Discharge Elimination System (NPDES) Permit); and 1806 (Determination and Extension of Contract Time)
Temporary Erosion / Sediment Control	The Plans; MnDOT 2573 Special Provisions: 2573 (Rapid Stabilization Specifications), and 2573 (Inlet Protection)
Maintenance of Devices / Sediment removal Removal or Tracked Sediment Removal of Devices	The Plans; MnDOT 2573.3; Special Provisions: 1514 (Maintenance During Construction); 1717 (Air, Land & Water Pollution), 1717 (National Pollutant Discharge Elimination System (NPDES) Permit), and 2573 (Inlet Protection)
Dewatering	MnDOT 2105.3B and 2451.3C; May also require DNR Permit
Temporary work not shown in the Plans Grading areas (unfinished acres exposed to erosion)	Special Provisions: 1717 (Air, Land & Water Pollution), 1717 (National Pollutant Discharge Elimination System (NPDES) Permit); 2573 (Erosion Control Supervisor), 2573 (Inlet Protection) and 2573 (Rapid Stabilization Methods).
Permanent Erosion / Sediment Control and Turf Establishment	The Plans; MnDOT 2573 and 2575; Special Provisions: 1717 (Air, Land & Water Pollution), 1717 (National Pollutant Discharge Elimination System (NPDES) Permit), and 2575 (Turf Establishment)

**Appendix B outlines Erosion and Sediment Control guidance for Land Disturbance Activities in the City of Minneapolis. It contains several BMP guidance documents and samples of: Inspector's Logs, Maintenance Record's Logs, and the NPDES Construction Site Permit Holder Inspection Form.**

**S-15 (1803) PROGRESS SCHEDULES**

The second paragraph of Section 1803.3 is hereby deleted and the following substituted therefore:

The hours of operations shall be limited to 7:00 a.m. until 6:00 p.m. Monday through Friday and from 8:00 a.m. until 6:00 p.m. on Saturday except when provisions of a Noise Permit further limit work hours. The Contractor shall contact Regulatory Services at 612-673-2635 to determine whether a Noise Permit is required and whether the Noise Permit will limit work hours. No work will be allowed on Sundays or outside these hours, unless an emergency situation exists and requires immediate correction.

**S-16 (2104) REMOVE PAVEMENT & MISCELLANEOUS STRUCTURES**

The provisions of MnDOT Specification 2104 shall govern as amended below:  
2104.3C Add the following:

All sewer infrastructure that is no longer of use and cannot be removed shall be abandoned in place. Any sewer pipe to be abandoned shall be bulk-headed with brick or concrete block masonry eight inches (8") thick at both ends and filled with material specified on the approved plans. A site verification of the abandonment work will be made by the Maintenance Supervisor of SWS Operations Office prior to backfilling the abandonment work on any part of the SWS Sewer or Storm Drain system. Contact telephone number for the Maintenance Supervisor is (612) 673-5625. The Contractor shall supply Record Drawings of the abandoned facilities in the Record Drawing Format specified in Section S-36 of this document.

Prior to restoring the trench area, the edges of the trench shall be trimmed back to a vertical face on a straight line which is parallel with the centerline of the trench. Trimming trench area shall be considered incidental to the Contract with no direct compensation made.

**S-17 (2105) EXCAVATION AND EMBANKMENT**

*Supplement MnDOT Section 2105 with the following:*

All excavations for this project must be adequately sloped, or sheeted and braced, in accordance with applicable Occupational Safety and Health Administration (OSHA) regulations. It is the sole responsibility of the Contractor to provide safe working conditions during all phases of construction and at all times on this project.

All excess material generated by the project shall become the property of the Contractor and shall be disposed of off the project site.

The contractor shall dispose of the excess material in conformance with the NPDES permit requirements for specific setbacks for stock piles from direct conveyances to waters of the state.

The Contractor shall not backfill around mudded joints within 24 hours unless approved by the Engineer.

If examination by the Engineer reveals that the need for additional subgrade excavation or placement of additional aggregate was caused by the Contractor's manipulation of the soils in the presence of excessive moisture, addition of excess water beyond what is necessary for compaction, or lack of proper dewatering, the cost of the corrective measures shall be borne by the Contractor.

### **S-18 (2112) SUBGRADE PREPARATION**

*Supplement MnDOT Section 2112 with the following:*

In the event that it is required to provide fill material, select granular fill conforming to MnDOT 3149.2B2 shall be used. In no case will river dredge sand be used. Class 5 Aggregate shall not be used for backfilling subgrade excavation.

All tests shall conform to MnDOT Grading and Base random method and number of tests will be determined by the City of Minneapolis Paving Engineer or Materials Engineer.

#### **Paving Engineer**

Larry Matsumoto  
1901 E 26<sup>th</sup> St, Minneapolis MN 55404  
Phone: 612-919-1148  
E-mail: [larry.matsumoto@minneapolismn.gov](mailto:larry.matsumoto@minneapolismn.gov)

#### **Materials Engineer**

Chris DeDene  
505 Fourth Ave. S Minneapolis, MN 55401  
Phone: 612-673-2823  
E-mail: [Chris.dedene@minneapolismn.gov](mailto:Chris.dedene@minneapolismn.gov)

In the event any privately owned below grade structure within the public right of way, also known as an areaway, is uncovered during this work, then all areaway improvements, modifications, or any areaway abandonment shall conform to City of Minneapolis Ordinance 95. Additional building permits may be required due to effects on the structure of a building. The Contractor should contact the Chief Building Official for the City of Minneapolis at (612) 673-5800, for additional information on the requirements.



**S-19 (2211) AGGREGATE BASE**

Section 2211 is hereby supplemented to include the following:

The use of recycled materials consisting primarily of crushed concrete and bituminous will be permitted only upon written acceptance from the Paving Engineer. The Paving Engineer shall require that the quality of each source be demonstrated prior to any acceptance.

The material will be required to meet all requirements of specifications 2211 and 3138.

Section 3138.2.C is modified to have a maximum bitumen content of 2.0 percent by weight.

Section 3138.2.C is amended to have no reclaimed glass or masonry block in this material.

All concrete pavement (new, repair, patches), alleys, driveways and curb and gutter shall use as aggregate base, MnDOT Class 5 materials. The aggregate base shall be compacted as per MnDOT specifications and will have a minimum thickness of 4.0 inches.

Density tests shall conform to MnDOT Dynamic Cone Penetrometer method. All tests shall conform to MnDOT Grading and Base random method and number of tests will be determined by the Paving Engineer.

**S-20 (2301) CONCRETE PAVEMENT**

*Supplement MnDOT Section 2301 with the following:*

Chloride-containing concrete additives and admixtures are not allowed.

The first batch ticket for each mix type, each day shall be signed by the concrete plant dispatcher.

(2301.3.L) Pavement Thickness Requirements

If the measured thickness of the concrete work is less than that given in the plan, and the deficient thickness is one half (1/2) inch or greater, then the deficient portion of the work shall be considered defective and shall be removed and replaced. In areas where there is deficient thickness the contractor may elect to saw cut the pavement at the closest contraction or expansion joint for replacement. Upon the direction of the Engineer, the contractor may be required to provide dowel bars as a part of the concrete replacement work.

Alley thickness shall be 8 inches of concrete.

Concrete bus pads shall be a minimum of 8 inches of concrete.

All dowel bars and tie bars shall be epoxy coated.

(2301.3.M) Curing Methods

1. Continue curing and protecting the concrete for at least 28 days. Protect the concrete from surface damage occurring from footprints, vandals, animals, debris, and the like.
2. Concreting in cold weather: During cold weather, concrete may be placed when the natural air temperature in the shade is 40 Degrees F. and rising. Concrete shall not be placed on frozen subgrade and/or base and materials containing frost, lumps or crusts of hardened materials. All concrete to be installed between October 1 and April 15 will require an approved cold weather concrete plan prior to any work. This plan must be approved by the City of Minneapolis Paving Engineer or Materials Engineer.

Assume full responsibility for the acceptable production, placement, finishing, and curing of all concrete under the conditions prevailing, regardless of the restrictions imposed. Provide any artificial lighting, rain or cold weather protection necessary at no additional cost to the City.

3. For any concrete installed between October 1 and April 15, the City of Minneapolis reserves the right to require the following items:
  - A. Electronic thermocouple(s) to be installed in the concrete, to record the temperature of the concrete and evaluate the possibility of any damage due to frozen concrete. The placement of the thermocouple(s) shall be at the rate of one thermocouple per 50 cubic yards of concrete and/or one thermocouple per each different type of concrete structures (sidewalk, pavement, curb and gutter, or drive approach). Placement, inspection and testing of thermocouples shall be performed by the City of Minneapolis, or by others if approved by the City of Minneapolis Paving Engineer or Materials Engineer. All costs for thermocouple work performed by the City shall be paid for prior to the issuance of the Sidewalk Construction Permit. Failure to maintain concrete temperatures above 40 degrees Fahrenheit during the initial 28 days of curing may result in a determination of failure and rejection of the work, unless other terms for the cold weather concreting plan are accepted by the City of Minneapolis Paving Engineer or Materials Engineer.

In general, the Paving Engineer will approve plans and modifications for permitted work, while the Materials Engineer will approve plans and modifications to work where the City is the Owner.

### **Paving Engineer**

Larry Matsumoto  
 1901 E 26<sup>th</sup> St, Minneapolis MN 55404  
 Phone: 612-919-1148  
 E-mail: [larry.matsumoto@minneapolismn.gov](mailto:larry.matsumoto@minneapolismn.gov)

### **Materials Engineer**

Chris DeDene  
505 Fourth Ave. S. Minneapolis, MN 55401  
Phone: 612-673-2823  
E-mail: [Chris.dedene@minneapolismn.gov](mailto:Chris.dedene@minneapolismn.gov)

- B. Concrete test cylinders to be cured on site, companion compressive strengths will be performed and failing compressive strengths of the test cylinder cured on site will be governed for acceptance of material.

(2301.3N) Joint construction

2301.3N shall be modified to include:

1. All tooled joints shall have a depth of 1/3 the thickness of the structure.
2. All 8-inch thick pavements (alley, driveway, street pavement) have tooled joints 2-inches deep.
3. All expansion felt, including expansion felt at 30' intervals in the sidewalk area, shall be placed as shown in shown in the City Standard Plates under Standard Plate Number ROAD-2003.
4. All expansion felt shall be bituminous impregnated.
5. All joints shall be evenly spaced, or as approved by the City Engineer.

**S-21 (2356) BITUMINOUS SEAL COAT**

The provisions of MnDOT 2356 are supplemented with the following:

During seal coating operations the Contractor shall prevent excess seal coat aggregates from entering storm or sanitary sewer structures in accordance with the applicable provisions of MnDOT 1717, 1803.5, and 2573. The Contractor shall contact the Maintenance Supervisor of SWS Operations Office 48 hours prior to commencing any seal coat work, the Contractor may inspect manholes and catch basins in the work area to document conditions prior to the start of seal coat operations. The contact telephone number for the Maintenance Supervisor is (612) 673-5625. The removal of any seal coat chips found in the storm or sanitary sewer systems after final sweep will be the responsibility of the Contractor. All costs associated with the control of excess aggregates shall be incidental to the seal coating as a whole and no direct compensation will be made.

The bituminous material for seal coating shall be CRS-2 asphalt emulsion.

The rate of CRS-2 application shall be designed. The emulsion application rate depends on gradation, absorption, shape, traffic volume, existing pavement condition and the residual asphalt content of binder. The CRS-2 designed rate of application shall be approved by the City of Minneapolis engineering lab.

The rate of application of seal coat chips shall be designed as well. The aggregates application rate depends on gradation, shape and specific gravity. The seal coat chips designed rate of application shall be approved by the City of Minneapolis engineering lab.

**The seal coat aggregate to be used on non-Parkway roadways** shall be a 100% crushed Class A **granite or trap rock** aggregate. Trap rock aggregate will be allowed to have the following modified FA-2 gradation:

Sieve Size	Percent Passing
6.30mm (1/4in)	100
4.75mm (#4)	0-100
2.36mm (#8)	0- 40
1.18mm (# 16)	0- 10
300um (# 50)	0-5
75um (# 200)	0-2.0

**The seal coat aggregate to be used on Parkways** shall be 3/8" seal coat chips meeting the following gradation specification:

Sieve Size	Percent Passing
12.5 mm	100
9.5 mm	95-100
4.75mm	0-30
75u	0-1.0

The accepted gradation methods used to determine the seal coat chips aggregate gradations are those described in the MnDOT Laboratory Manual.

At such time as determined by the Engineer that seal coating aggregates have properly set, the Contractor shall remove all excess aggregates from roadways, adjacent sidewalks, and property. Removal shall be accomplished by means of shoveling or sweeping, not by street washing. All costs due to maintenance of public roadways shall be incidental to the seal coating as a whole and no direct compensation will be made therefore.

The City of Minneapolis shall retain all reclaimed seal coat aggregates. Therefore, the Contractor shall be required to haul and deposit seal coat chips to a designated location within the City of Minneapolis.

The Contractor shall provide all necessary traffic control for seal coating operations as required by MnDOT 1404 and modified by these special provisions. Traffic control devices for seal coating shall include, but not be limited to, centerline markers and reflectorized barrels that clearly delineate the traffic lanes during seal coating operations and until such time as determined by the Engineer that seal coating aggregates have set sufficiently to permit painting of lane striping and pavement markings by the City of Minneapolis Traffic Department.

**S-22 (2360) PLANT MIXED ASPHALT PAVEMENT (SUPERPAVE)**

Section 2360.3.C.1 is hereby modified to require all cold joints (transverse and longitudinal) to be cut vertically for the full depth of the matching asphalt thickness placed previously. All longitudinal joints are to be matched with adjacent passes as much as practical and the maximum length of each adjacent pass shall not exceed 800 feet during paving. At the end of the day’s paving no more than 800 feet (longitudinal) shall be created and prior to the next paving activity this longitudinal shall be cut vertically to match the next pass.

Tables 2360-22 and 2360-23 shall not apply. Any individual asphalt cores failing to meet minimum specified density of 92% will be considered failure for the entire lot and asphalt placed that day shall be removed and replaced, unless there is a negotiated agreement that is approved by the City Engineer, or their designee, and agreed to, in writing, by all involved parties to mitigate the failure to meet the density specification.

Section 2360.3.D.1.h. is hereby modified as follows:

- Mat density cores will be taken for any quantity larger than 10 tons per individual area of placement. For quantities larger than 10 tons and less than 300 tons per individual area of placement obtain a minimum of two cores as directed by the engineer. Companion cores would be in addition to the two cores taken.
- For quantities less than 10 tons per individual area, ordinary compaction rules shall apply. Advanced notice is required to be given to observe placement of these individual areas.
- Do not take cores for compacted mat density within 1 ft of any longitudinal joint or 2 ft of any structure.

**Pavement surface smoothness will not be evaluated on the plant mixed asphalt pavement by specification 2399.** The sentence “In addition to the list the above pavement surface must meet requirements of 2399 (Pavement Surface Smoothness) requirements.” is deleted from **2360.3.E Surface Requirements** of the **2360 (Plant Mixed Asphalt Pavement) Specification**. The other requirements of 2360.3.E Surface Requirements **will** apply.

The bituminous mixture designations to be used in the City of Minneapolis shall be as follows:

<u>Commercial wearing course mixture:</u>	SPWEB540L (Notes 1 & 2)
<u>Residential wearing coarse mixture:</u>	SPWEB440L (Note 2)
<u>Non-wearing course mixture :</u>	SPNWB430L (Note 2)

Notes

1. In no case will recycled materials be allowed in this mix.
2. In no case will asphalt shingles be allowed in the mix.

Bituminous Placement

The pavement shall be swept clean prior to placement of bituminous wear course. This work shall be considered incidental to the Contract with no direct compensation made therefore.

**Joint Establishment**

Transverse crack control joints are required to be saw cut into all new asphalt pavements constructed to full depth. Provide transverse-joint sawing as shown on the plans or as directed by the Engineer. Perform the initial sawing prior to the first winter experienced by the pavement. Extend transverse joints constructed in the pavement through the integrant curb. Saw cutting, cleaning and sealing shall not be done within 48 hours of placement of the wear course.

Immediately after completing the joint sawing, use water or air under pressure to remove the sawing residue from each joint and the pavement surface.

Sealed joints shall be rejected if there is evidence of poor workmanship or obvious defects, such as, but not limited to the following:

- (a) Sawed joint not filled completely
- (b) Lack of bond to the sides of the joint
- (c) Excessive debris or moisture in the joint
- (d) Contamination of the sealant
- (e) Sawed joint not filled flush

Rejected sealed joints shall be repaired, the sealant removed and disposed of in an appropriate manner and the joints resealed as necessary, to the Engineer's satisfaction and at no cost to the City.

If no bid items are provided, this work shall be considered incidental to the asphalt pavement with no direct compensation made therefore.

**Joint Sealing**

All saw cut crack control joints are to be sealed with a joint sealant in accordance with 3725, "Hot-Poured, Extra-Low Modulus, Elastic-Type Joint and Crack Sealer," unless the type of sealant for contraction joints is otherwise specified in the contract.

Perform joint sealing as shown on the plans and in accordance with the following:

- (1) Seal joints after the Engineer inspects and approves the joints;
- (2) Perform joint sealing on surface dry asphalt after cleaning the joints of debris, dirt, dust, and other foreign matter, including accumulations of asphalt;
- (3) Lightly sandblast the joint walls before final compressed air cleaning;
- (4) Immediately before sealing the joints, clean the joints with a jet of compressed air under pressure of at least 85 psi;
- (5) Seal transverse integrant curb joints and shoulders with the same joint sealer used to seal the pavement joints;
- (6) Seal joints in accordance with the tolerances shown on the plans;
- (7) When required, provide backer rod material compatible with the sealer as shown on the plans; and
- (8) Remove and replace sealer at joints filled above the permissible level shown on the plans at no additional cost to the City.

Handle and place joint sealer material as recommended by the manufacturer and in accordance with the following requirements:

### **Hot-Poured Sealers**

Heat hot-poured sealers in a double-boiler type kettle or melter. Fill the space between inner and outer shells with oil or other material as allowed by the manufacturer. Provide heating equipment with automatic temperature control, mechanical agitation, and recirculating pump. Use heating equipment as recommended by the manufacturer of the sealer material. Do not use sealer material that has been previously melted. After heating the sealer material to the application temperature, maintain the material temperature until placement. Place the sealer material within 4 hours after the initial heating to the application temperature.

## **S-23 (2461) STRUCTURAL CONCRETE**

*Supplement MnDOT Section 2461 with the following:*

(2461.F.2.a) The Department defines the concrete mix design requirements for Contractor Design Mixes in accordance with Table 2461-6.

The first batch ticket for each mix type, each day shall be signed by the concrete plant dispatcher.

Contractor grade mixes that are not certified by MnDOT are not allowed.

*Replace MnDOT Section 2461.3.G.1 with the following:*

### **Notice of Inspection**

Notify the City of Minneapolis or testing agency a minimum of 24 hours before beginning concrete production to allow the Engineer time to provide inspection forces needed for the work and to approve preparations for concrete placement. If the Contractor fails to provide 24 h notice, the Engineer may delay concrete placement in accordance with 1503, "Conformity with Plans and Specifications" and 1512, "Unacceptable and Unauthorized Work."

## **S-24 EXCAVATION AND PREPARATION OF TRENCH**

### Description

This work shall consist of the excavation, backfilling, and restoration of existing surface improvements for the purposes of installing new and/or relocating or adjusting existing underground utilities.

### Operational Limitations and Requirements

Excavating operations shall proceed only so far in advance of pipe lying as will satisfy the needs for coordination of work and permit advance verification of unobstructed line and grade as planned. Where interference with existing structures is possible or in any way indicated, and

where necessary to establish elevation or direction for connections to in-place structures, the excavating shall be done at those locations in advance of the main operation so actual conditions will be exposed in sufficient time to make adjustments without resorting to extra work or unnecessary delay.

Wherever possible, excavated materials shall be placed in areas that will not block existing vehicle and pedestrian traffic. No excavated material shall be placed in any drainage way in the City. The Contractor shall review proposed methods of operation with the Engineer prior to beginning the work. All installations shall be accomplished by open trench construction except for short tunnel sections approved by the Engineer and with the exception that boring and jacking or tunnel construction methods shall be employed where so specifically required by the Plans, Specifications, or Special Provisions.

Installation of pipe through tunnel excavations will be allowed only where the surface structure can be properly supported and the backfill restored to the satisfaction of the Engineer. The excavating operations shall be conducted so as to carefully expose all in-place underground structures without damage. Wherever the excavation extends under or approaches so close to an existing structure as to endanger it in any way, precautions and protective measures shall be taken as necessary to preserve the structure and provide temporary support. Hand methods of excavating shall be utilized to probe for and expose such critical or hazardous installations as gas pipe and power or communication cables.

The Engineer shall be notified of any need for blasting to remove materials which cannot be broken up mechanically, and there shall be no blasting operations conducted until the Engineer's approval has been secured. Blasting will be allowed only when proper precautions are taken to protect life and property, and then shall be restricted as the Engineer directs. The hours of blasting operations shall be set by the Owner. The Contractor shall assume full responsibility for any damages caused by blasting, regardless of the requirements for notification and approval. The Contractor shall secure any required permits for blasting and shall conduct blasting operations in conformance with all applicable local, state and federal laws, regulations, and ordinances.

#### Classification and Disposition of Materials

Excavated materials will be classified for payment only to the extent that the removal of materials classified by the Engineer as Rock will be paid for as provided in the Special Provisions or shown in the Proposal. All other materials encountered in the excavations, with the exception of items classified for payment as structure removals, will be considered as Unclassified Excavation and unless otherwise specified in the Plans, Specifications, and Special Provisions, no additional compensation shall be provided for their removal.

Unclassified materials shall include muck, rubble, wood debris, and boulder stone, masonry or concrete fragments less than one cubic yard in volume, together with other miscellaneous matter that can be removed effectively with power operated excavators without resorting to drilling and blasting.



Rock excavation shall be defined to include all hard, solid rock in ledge formation, bedded deposits and unstratified masses; all natural conglomerate deposits so firmly cemented as to present all the characteristics of solid rock; and any boulder stone, masonry or concrete fragments exceeding one cubic yard in volume. Materials such as shale, hard pan, soft or disintegrated rock which can be dislodged with a hand pick or removed with a power operated excavator will not be classified as Rock Excavation.

Excavated materials will be classified for reuse as being either Suitable or Unsuitable for backfill or other specified use, subject to selective controls. All suitable materials shall be reserved for backfill to the extent needed, and any surplus remaining shall be utilized for other construction on the project as may be specified or ordered by the Engineer. To the extent practicable, granular materials and topsoil shall be segregated from other materials during the excavating and stockpiling operations so as to permit best use of the available materials at the time of backfilling. Unless otherwise specified in the Plans, Specifications, and Special Provisions, material handling as described above shall be considered incidental with no additional compensation provided.

All excavated materials reserved for backfill or other use on the project shall be stored at locations approved by the Engineer that will cause a minimum of inconvenience to public travel, adjacent properties, and other special interests. The material shall not be deposited so close to the edges of the excavations as this would create hazardous conditions, nor shall any material be placed so as to block the access to emergency services. All materials considered unsuitable by the Engineer, for any use on the project, shall be immediately removed from the project and be disposed of as arranged for by the Contractor at no extra cost to the Contract.

#### Excavation Limitations and Requirements

Trench excavating shall be to a depth that will permit preparation of the foundation as specified and installation of the pipeline and appurtenances at the prescribed line and grade, except where alterations are specifically authorized. Trench widths shall be sufficient to permit the pipe to be laid and joined properly and the backfill to be placed and compacted as specified. Extra width shall be provided as necessary to permit convenient placement of sheeting and shoring and to accommodate placement of appurtenances.

Excavations shall be extended below the bottom of structure as necessary to accommodate any required Granular Foundation material. When rock or unstable foundation materials are encountered at the established grade, additional materials shall be removed as specified or ordered by the Engineer to produce an acceptable foundation. Unless otherwise indicated or directed, rock shall be removed to an elevation at least six inches below the bottom surface of the pipe barrel and below the lowest projection of joint hubs. All excavations below grade shall be to a minimum width equal to the outside pipe diameter plus two feet. Rock shall be removed to such additional horizontal dimensions as will provide a minimum clearance of six inches on all sides of appurtenant structures such as valves, housings, access structures, etc.

Where no other grade controls are indicated or established for the pipeline, the excavating and foundation preparations shall be such as to provide a minimum cover over the top of the pipe as specified. Trench widths shall allow for at least six inches of clearance on each side of the

joint hubs. The maximum allowable width of the trench at the top of pipe level shall be the outside diameter of the pipe plus two feet, subject to the considerations for alternate pipe loading set forth below. The width of the trench at the ground surface shall be held to a minimum to prevent unnecessary destruction of the surface structures. Under no circumstances shall the trench with shoring be so narrow that it does not conform to OSHA Standard -29 CFR 1926.

The maximum allowable trench width at the level of the top of pipe may be exceeded only by approval of the Engineer, after consideration of pipe strength and loading relationships. Any alternate proposals made by the Contractor shall be in writing, giving the pertinent soil weight data and proposed pipe strength alternate, at least seven days prior to the desired date of decision. Approval of alternate pipe designs shall be with the understanding that there will be no extra compensation allowed for any increase in material or construction costs.

If the trench is excavated to a greater width than that authorized, the Engineer may direct the Contractor to provide a higher class of bedding and/or a higher strength pipe than that required by the Plans, Specifications, and Special Provisions in order to satisfy design requirements, without additional compensation.

#### Sheeting and Bracing Excavations

All excavations must comply with the requirements of OSHA Standard CFR 1926. The excavations shall be sloped, benched, sheeted, shored, or braced or any combination of these protective measures so that the excavation will meet all requirements of the applicable safety codes and regulations; comply with any specific requirements of the Contract; and prevent disturbance or settlement of adjacent surfaces, foundations, structures, utilities, and other properties. Any damage to the work under contract or to adjacent structures or property caused by settlement, water or earth pressures, slides, cave-ins, or other causes due to failure or lack of sheeting, shoring, or bracing or through negligence or fault of the Contractor in any manner shall be repaired at the Contractor's expense and without delay.

Where conditions warrant extreme care, the Plans, Specifications, and Special Provisions may require special precautions to protect life or property, or the Engineer may order the installation of sheet piling of the interlocking type or direct that other safety measures be taken as deemed necessary. Failure of the Engineer to order correction of improper or inadequate sheeting, shoring, or bracing shall not relieve the Contractor's responsibilities for protection of life, property, and the work.

The Contractor shall assume full responsibility for proper and adequate placement of sheeting, shoring, and bracing, wherever and to such depths that soil stability may dictate the need for support to prevent displacement. The Contractor shall be responsible for obtaining the services of a Professional Engineer, registered in Minnesota, to design bracing that will provide ample working space while not placing any stress or strain on the in-place structures to any extent that may cause damage.

Sheeting, shoring and bracing materials shall be removed only when and in such manner as will assure adequate protection of the in-place structures and prevent displacement of supported grounds. Sheeting and bracing shall be left in place only as required by the Plans, Specifications, and Special Provisions or ordered by the Engineer. Otherwise, sheeting and bracing may be removed as the backfilling reaches the level of respective support. Wherever sheeting and bracing is left in place, the upper portions shall be cut and removed to an elevation of three feet or more below the established surface grade as the Engineer may direct.

All costs of furnishing, placing and removing sheeting, shoring, and bracing materials, including the value of materials left in place as required by the Contract, shall be included in the prices bid for pipe installation and will not be compensated for separately. When any sheeting, shoring, or bracing materials are left in place by written order of the Engineer, in the absence of specific requirements of the Contract to do so, payment will be made for those materials as an Extra Work item, including waste material resulting from upper cut-off requirements.

#### Preparation and Maintenance of Foundations

Foundation preparations shall be conducted as necessary to produce a stable foundation and provide continuous and uniform pipe bearing between bell holes. The initial excavating or backfilling operations shall produce a subgrade level slightly above finished grade as will permit hand shaping to finished grade by trimming of high spots and without the need for filling of low spots to grade. Final subgrade preparations shall be such as to produce a finished grade at the centerline of the pipe that is within 0.03 foot of a straight line between pipe joints and to provide bell hole excavation at each joint as will permit proper joining of pipe and fittings.

In excavations made below grade to remove rock or unstable materials, the backfilling to grade may be made with available suitable materials approved by the Engineer, unless placement of Granular Foundation or Bedding material is specified or is ordered by the Engineer. Placement of the backfill shall be in relatively uniform layers not exceeding 8 inches in loose thickness. Each layer of backfill shall be compacted to the density required for the restoration surfacing, by means of approved mechanical compaction equipment, as will produce uniform pipe support throughout the full pipe length and facilitate proper shaping of the pipe bed.

Where placement of foundation materials will not provide an adequate foundation for laying pipe due to the instability of the existing materials and where ordered by the Engineer, the Contractor shall place Geotextile Type I fabric on top of the unstable materials prior to placing foundation materials. Sufficient geotextile fabric shall be used to completely enclose the foundation materials and pipe.

It shall be the Contractor's responsibility to notify the Engineer of changing soil conditions which may be of poor bearing capacity and when organic soils are encountered. Where utilities are placed on unstable soils without notification of the Engineer, the Contractor shall be responsible for all repairs and correction of the installation without further compensation.

Where the foundation soil is found to consist of materials that the Engineer considers to be so unstable as to preclude removal and replacement to a reasonable depth to achieve solid support, a suitable foundation shall be constructed as the Engineer directs in the absence of special requirements in the Plans, Specifications, and Special Provisions. The Contractor may be required to furnish and drive piling and construct concrete or timber bearing supports or other work as may be ordered by the Engineer.

Care shall be taken during final subgrade shaping to prevent any over-excavation. Should any low spots develop, they shall only be filled with approved material, which shall have optimum moisture content and be compacted thoroughly without additional compensation to the Contractor. The finished subgrade shall be maintained free of water and shall not be disturbed during pipe lowering operations except as necessary to remove pipe slings. The discharge of trench dewatering pumps shall be directed to natural drainage channels or storm water drains after being filtered to remove suspended solids in accordance with the State of Minnesota NPDES General Permit. Draining trench water into sanitary sewers or combined sewers is normally not permitted.

The Contractor shall install and operate a dewatering system of wells or points to maintain pipe trenches free of water wherever necessary or as directed by the Engineer to meet the intent of these specifications. Unless otherwise specified in the Plans, Specifications, and Special Provisions, such work shall be considered incidental.

All costs of excavating below grade and placing foundation or bedding aggregates as shown on the details for bedding shall be included in the bid prices for pipe items to the extent that the need for such work is shown on the plans or indicated in these Supplemental Specifications and the Proposal does not provide for payment under separate Contract Items. Any excavation below the grade of the bedding and any foundation or bedding aggregates required by order of the Engineer in the absence of Contract requirements will be compensated for separately.

If examination by the Engineer reveals that the need for placement of foundation aggregate was caused by the Contractor's manipulation of the soils in the presence of excessive moisture or lack of proper dewatering, the cost of the corrective measures shall be borne by the Contractor.

#### Non-Open Cut and Special Pipe Installation

##### A Jacking / Boring

The terms "auger", "boring", "jack", "jacking", and "tunneling" in the proposal, specifications, and plans refers only to non-open cut construction. The Contractor shall inspect and verify soil conditions to his own satisfaction in order to determine the type of construction to employ. During the construction, the Contractor shall be responsible for protecting all existing utilities above the pipe invert.

The minimum diameter of the casing pipe shall be four (4) inches greater than the outside diameter of the bell of the carrier pipe. For any installation beneath a railroad, the top of the casing pipe shall not be closer than the specified dimensions indicated in the permit.

If the Contractor elects to install steel casing, the minimum wall thickness shall be as specified on the Plans, in the Special Provisions, or in the applicable Permit. Where required by the Engineer, two 17-pound anode packs shall be attached to the casing for corrosion protection.

A 1-1/2 inch pipe shall be forced along the top of the casing pipe. The front end of this pipe shall be 18 inches behind the front end of the casing pipe. A mixture of water and bentonite clay shall be forced through this pipe at all times during the casing installation to fill any voids that may be present above the casing pipe. Upon completion of the casing installation, this pipe shall be slowly withdrawn while bentonite is forced through the pipe to fill any remaining voids.

The Contractor shall prevent excavated materials from flowing back into the excavation during the non-open cut construction. This shall include the use of a shield conforming to the size and shape of the casing that will prevent materials from flowing into the leading edge of the casing. The machine used shall be capable of controlling line and grade and shall conform to the size and shape of the casing pipe.

No jacking/auguring of pipe will be allowed below the water table unless the water table has been lowered sufficiently to keep the water below the pipe being installed. The use of water under pressure (jetting) or puddling will not be permitted to facilitate jacking/auguring operations.

If any installation is augured, the head shall be approved by the Engineer and the auger shall be located six (6) inches behind the lead edge of the casing or carrier pipe.

If a void develops, the jacking/auguring shall be stopped immediately and the void shall be filled by pressure grouting. The grout material shall consist of sand-cement slurry of at least two sacks of cement per cubic yard and a minimum of water to assure satisfactory placement.

Skids and blocking shall be used as necessary to install the carrier pipe to the proper line and grade inside the casing pipe. Voids between carrier and casing pipes shall be filled with sand and the casing pipe sealed at both ends with a suitable material to prevent water or debris from entering the casing pipe.

#### B Directional Boring

Directional boring/drilling installation shall be accomplished where required on the Plans or in the Special Provisions to minimize disturbance of existing surface improvements. The installer shall have a minimum of three years of experience in this method of construction and have installed at least 1,000 feet of 8-inch or larger diameter pipe to specified grades. The field supervisor employed by the Contractor shall have at least three years of experience, be responsible for all of the boring/drilling work and shall be at the site at all times during the boring/drilling installation.

The Contractor shall submit boring/drilling pit locations and dimensions to the Engineer before beginning construction.

The drilling equipment shall be capable of placing the pipe as shown on the plans. The installation shall be by a steerable drilling tool capable of installing continuous runs of pipe, without intermediate pits, a minimum distance of 200 feet. The guidance system shall be capable of installing pipe within 1-1/2 inch of the plan vertical dimensions and 2 inches of the plan horizontal dimensions. The Contractor shall be required to remove and reinstall pipes which vary in depth and alignment from these tolerances.

Pull back forces shall not exceed the allowable pulling forces for the pipe being installed. Drilling fluid shall be a mixture of water and bentonite clay. Disposal of excess fluid and spoils shall be the responsibility of the Contractor

### C Placement of Insulation

Two inches of polystyrene rigid insulation board with a minimum compressive strength of 60 psi and a minimum R-value of 10.0 shall be placed within the pipe encasement zone, 6 inches above the pipe. Prior to placement of the insulation, Granular Borrow (MnDOT 3149) shall be leveled and compacted until there is no further visual evidence of increased consolidation or the density of the compacted layer conforms to the density requirements specified in the Special Provisions, then leveled and lightly scarified to a depth of 1/2 inch. Borrow material placed above and below the insulation shall be free of rock or stone fragments measuring 1-1/2 inches or greater.

Insulation boards shall be placed on the scarified material with the long dimension parallel to the centerline of the pipe. Boards shall be placed in a single layer with tight joints. No continuous joints or seams shall be placed directly over the pipe. If two or more layers of insulation boards are used, each layer shall be placed to cover the joints of the layer immediately below.

The Contractor shall exercise precaution to insure that all joints between boards are tight during placement and backfilling with only extruded ends placed end to end or edge to edge.

The first layer of material placed over the insulation shall be 6 inches in depth, free of rock or stone fragments measuring 1-1/2 inches or greater. The material shall be placed in such a manner that construction equipment does not operate directly on the insulation and shall be compacted with equipment which exerts a contract pressure of less than 80 psi. The first layer shall be compacted to conform to the density requirements specified in the Special Provisions.

### Pipeline Backfilling Operations

Placement and compaction of back fill soil outside of the pipe zone shall comply with all other special provisions stated in this document or MnDOT Standards. All pipeline excavations shall be backfilled to restore preexisting conditions as the minimum requirement, and fulfill all supplementary requirements indicated in the Plans, Specifications, and Special Provisions. The backfilling operations shall be started as soon as conditions will permit on each section of pipeline, so as to provide continuity in subsequent operations and restore normal public service as soon as practicable on a section-by-section basis. All operations shall be pursued diligently, with proper and adequate equipment, as will assure acceptable results.

The backfilling shall be accomplished with the use of Suitable Materials selected from the excavated materials to the extent available and practical. Should the materials available within the trench section be unsuitable or insufficient, without loading and hauling or other measures the Engineer determines to be unreasonable, the required additional materials shall be furnished from outside sources as Extra Work under MnDOT Specification 1403 in the absence of any Special Provision requirements covering additional material.

Suitable Material shall be defined as a mineral soil free of foreign materials (rubbish, debris, etc.), frozen clumps, oversize stone, rock, concrete or bituminous chunks, hazardous material and other unsuitable materials, that may damage the pipe installation, prevent thorough compaction, or increase the risks of after settlement unnecessarily. Material selection shall be such as to make the best and fullest utilization of what is available, taking into consideration particular needs of different backfill zones. Material containing stone, rock, or chunks of any sort shall only be utilized where and to the extent there will be no detrimental effects. The determination of detrimental effects is subject to the review and determination by the Engineer.

Within the pipe bedding and encasement zones described as that portion of the trench which is below an elevation one foot above the top of the pipe, the materials placed shall be limited in particle size to 1-1/2 inches maximum in the case of pipe of 12 inches in diameter or less and to 2 inches maximum in the case of larger pipe. Above these zones, the placement of material containing stones, boulders, chunks, etc. greater than 6 inches in any dimension shall not be allowed.

All flexible pipe shall be bedded in accordance with ASTM Specification D2321, "Recommended Practice for Underground Installation of Flexible Thermoplastic Sewer Pipe". This shall include placement of granular bedding and encasement materials from a point six inches below the bottom of pipe to a point twelve inches above the top of the pipe. Placement and compaction of bedding and encasement materials around the pipe shall be considered incidental to the installation of the pipe. Where existing soils do not meet the requirements of bedding and encasement materials, the Contractor shall furnish the required granular materials.

Compaction of materials placed within the pipe bedding and encasement zones shall be accomplished with portable or hand equipment methods, so as to achieve thorough consolidation under and around the pipe and avoid damage to the pipe. Above the cover zone material, the use of heavy roller type compaction equipment shall be limited to safe pipe loading.

Backfill materials shall be carefully placed in uniform loose thickness layers up to 12 inches thick spread over the full width and length of the trench section to provide simultaneous support on both sides of the pipeline. Granular backfill may be placed in 12 inch layers above an elevation one foot above the top of the pipe, and with the provision that, by authority and at the discretion of the Engineer in consideration of the demonstrated capability of special type vibrating compactors, the stated maximums may be increased.

Each layer of backfill material shall be compacted effectively, by approved mechanical or hand methods, until there is no further visual evidence of increased consolidation or the density of the compacted layer conforms to the density requirements specified in the Special Provisions. Compaction of the in-place layer shall be completed acceptably before placing material for a

succeeding layer thereon. The manner of placement, compaction equipment, or procedure effectiveness shall be subject to approval of the Engineer.

All surplus or waste materials remaining after completion of the backfilling operations shall be disposed of in an approved manner within 24 hours after completing the backfill work on each particular pipeline section. Disposal at any location within the project limits shall be as specified, or as approved by the Engineer; otherwise, disposal shall be accomplished outside the project limits by the Contractor. The backfilling and surplus or waste disposal operations shall be a part of the work required under the pipeline installation items, not as work that may be delayed until final cleanup.

Compaction of backfill within Roadbed areas shall meet the density requirements of MnDOT Specification 2105. Compaction of backfill in all other areas shall be as required in the Special Provisions.

Until expiration of the guarantee period, the Contractor shall assume full responsibility and expense for all backfill settlement and shall refill and restore the work as directed to maintain an acceptable surface condition, regardless of location. All additional materials required shall be furnished without additional cost to the Owner.

Any settlement of road surfaces that are either placed under this Contract or by others under either public or private contract; that are in excess of one inch, as measured by a ten foot straight edge; and that are within the guarantee period shall be considered failure of the mechanical compaction. The Contractor shall be required to repair such settlement including all items placed by others.

#### Restoration of Surface Improvements

Wherever any surface improvements such as pavement, curbing, pedestrian walks, fencing, or turf have been removed, damaged or otherwise disturbed by the Contractor's operations, they shall be repaired or replaced to the Engineer's satisfaction, as will restore the improvement in kind and structure to the preexisting condition. Each item of restoration work shall be done as soon as practicable after completion of installation and backfilling operations on each section of pipeline.

In the absence of specific payment provisions, as separate Contract Items, the restoration work shall be compensated for as part of the work required under those Contract Items which necessitated the destruction and replacement or repair, and there will be no separate payment. If separate pay items are provided for restoration work, only that portion of the repair or reconstruction which was necessitated by the Contract work will be measured for payment. Any improvements removed or damaged unnecessarily or undermined shall be replaced or repaired at the Contractor's expense

#### Turf Restoration

Turf restoration shall be accomplished by sod placement except where seeding is specifically allowed or required.

Topsoil shall be placed to a minimum depth of four inches under all sod and in all areas seeded. The topsoil material used shall be light friable loam containing a liberal amount of humus and



shall be free of heavy clay, coarse sand, stones, plants, roots, sticks and other foreign matter. Topsoil meeting these requirements shall be selected from the excavated materials to the extent available and needed.

Wherever turf is placed directly adjacent to a sidewalk, the final, installed height of the turf must be lower than the sidewalk to ensure proper drainage of water off of the sidewalk.

All turf establishment work shall be done in substantial compliance with the provisions of MnDOT Specification 2575 using seed mixtures as specified in the Special Provisions or Proposal

#### Pavement Restoration

The in-place pavement structure (including base aggregates) shall be restored in kind and depth as previously existed, using base aggregates salvaged from the excavated materials to the extent available and needed, and with new materials being provided for reconstruction of the concrete or bituminous surface courses.

During restoration if questions arise due to inconsistent existing pavement, contact the City of Minneapolis engineering laboratory prior placement at 612-673-2368.

If, through no fault of the Contractor in failing to reserve sufficient aggregate materials from the excavations, there should be insufficient quantity of suitable aggregate to reconstruct the pavement base courses, the additional materials required will be furnished by the Contractor as an Extra Work Item from outside sources. Placement of any additional aggregate materials delivered to the site by the Owner or of any additional materials furnished by the Contractor shall be an incidental expense, as will also be the disposal of any excess materials resulting there from, unless special payment provisions are otherwise agreed upon.

Reconstruction of aggregate base courses and concrete or bituminous surface courses shall be in substantial compliance with all applicable MnDOT Specifications pertaining to the item being restored. The materials used shall be comparable to those used in the in-place structure, and the workmanship and finished quality shall be equal to that of new construction to the fullest extent obtainable in consideration of operational restrictions.

Existing concrete and bituminous surfaces at the trench wall shall be sawed or cut with a cutting wheel to form a neat edge in a straight line before surfaces are to be restored. Sawing or cutting may be accomplished as a part of the removal or prior to restoration at the option of the Contractor. However, all surface edges will be inspected prior to restoration.

Pavement restoration shall also comply with other specifications in this document.

#### Restoration of Miscellaneous Items

Wherever any curbing, curb and gutter sections, pedestrian walks, fencing, driveway surfacing, or other improvements are removed or in any way damaged or undermined, they shall be restored to original condition by repair or replacement as the Engineer considers necessary. Replacement of old materials will be acceptable only to the extent that existing quality can be fully achieved, such as in the case of fencing. Otherwise new materials shall be provided and placed as the Engineer directs. Workmanship and finished quality shall be equal to that of new construction, where new materials are used, to the extent obtainable in consideration of operational restrictions.

A proper foundation shall be prepared before reconstructing concrete or bituminous improvements. Unless otherwise directed, granular material shall be placed to a depth of at least four inches under all concrete and bituminous items. No direct compensation will be made for furnishing and placing this material even though such course was not part of the original construction.

#### Maintenance and Final Cleanup

All subgrade surfaces shall be maintained acceptably until the start of surfacing construction or restoration work, and until the work has been finally accepted. Additional materials shall be provided and placed as needed to compensate for trench settlement and to serve as temporary construction pending completion of the final surface improvements.

Final disposal of debris, waste materials, and other remains or consequences of construction, shall be accomplished intermittently as new construction items are completed and shall not be left to await final completion of all work. Cleanup operations shall be considered as being a part of the work covered under the Contract Items involved and only that work which cannot be accomplished at any early time shall be considered as final cleanup work not attributable to a specific Contract Item.

If disposal operations and other cleanup work are not conducted properly as the construction progresses, the Engineer may withhold partial payments until such work is satisfactorily pursued or he may deduct the estimated cost of its performance from the partial estimate value.

Maintenance of sodded and seeded areas shall include adequate watering for plant growth and the replacement of any dead or damaged sod as may be required for acceptance of the work. Corrective action shall be required in accordance with Table 2575-3.

### **S-25 (2502) SUBSURFACE DRAINS**

The work consists of providing all materials, equipment, and labor required for the installation of perforated and solid-wall subsurface drains using plant-fabricated pipe and appurtenant materials.

#### 2502.2 Materials

The materials used in construction of the subsurface drains must be in compliance with the provisions in MnDOT Standard Specification 2502, according to the details in the Plans and with the following.

Fine Filter Material – Fine Filter Aggregate must meet the requirements of MnDOT 3149.2J.2, with the additional requirement that not more than 35 percent shall pass the No. 10 sieve and not more than five percent shall pass the No. 40 sieve.

Perforated Drains - All perforated PE pipe drain specified in the Plans will be Corrugated Polyethylene Drainage Tubing (PE) and perforations shall be uniform slots, not drilled holes. The pipe and all fittings must meet the requirements of MnDOT Standard Specification 3278.

Clean Outs and Inspection Risers – The pipe used to fabricate clean outs and inspection risers must conform to MnDOT Standard Specification 3247. The ductile iron cover must conform to MnDOT Standard Specification 3324.

### 2502.3 Construction Requirements

A. Subsurface Drains – Construction of the subsurface drains must be in accordance with MnDOT Standard Specification 2502 and according to the details in the Plans. This includes, but is not limited to, the pipes, filter material, fittings, couplings, and clean outs.

The CONTRACTOR must provide record drawings with coordinates and elevations of the subsurface drainage system after installation in accordance with the SWS Record Drawing Standards approved by the Surface Waters and Sewers Division of Public Works.

B. Fine Filter Material - Prevent mixing of dissimilar materials during unloading, stockpiling, or removal from stockpile.

The Fine Filter aggregate must be placed in a manner that constructs a continuous filter for the engineered soil with no gaps or mixing of soils.

The Fine Filter aggregate must be inspected and approved by the ENGINEER prior to covering. If the ENGINEER deems that the Fine Filter aggregate has been contaminated, the CONTRACTOR will remove the contaminated material and replace with clean aggregate to the ENGINEER'S satisfaction at the CONTRACTOR'S expense.

The CONTRACTOR shall construct all Fine Filter, unless otherwise noted, to the correct position based on the line and grade information provided by the CITY. Additionally, the CONTRACTOR must construct the Fine Filter aggregate to the lines, grades and thickness shown on the plans. The allowable tolerances are:

0.5 feet horizontal, 0.1 feet vertical

## **S-26 (2503) PIPE SEWERS**

For the purpose of these Standard Supplemental Specifications MnDOT 2503 shall govern, except with the following modifications and amendment(s):

### (2503.1) Description

Use of the term "Plans, Specifications, and Special Provisions" within this specification shall be construed to mean those documents which compliment, modify, or clarify these specifications and are accepted as an enforceable component of the Contract or Contract Documents. All references to MnDOT Specifications shall mean the latest published edition of the Minnesota Department of Transportation Standard Specifications for Construction as modified by any MnDOT Supplemental Specifications issued before the date of advertisement for bids. All references to other Specifications of AASHTO, ASTM, ANSI, AWWA, etc. shall mean the latest published edition available on the date of advertisement for bids.

### (2503.2) Materials

### A. General

All materials required for this work shall be new material conforming to requirements of the referenced specifications for the class, kind, type, size, grade, and other details indicated in the Contract Documents. Unless otherwise indicated, all required materials shall be furnished by the Contractor. If any options are provided for, as to type, grade, or design of the material, the choice shall be limited as may be stipulated in the Contract Documents.

All manufactured products shall conform in detail to such standard design drawings as may be referenced or furnished in the Plans. Otherwise, the Owner may require advance approval of material suppliers, product design, or other unspecified details as it deems desirable for maintaining adopted standards.

At the request of the Engineer, the Contractor shall submit in writing a list of materials and suppliers for approval. Suppliers shall submit a Certificate of Compliance that the materials furnished have been tested and are in compliance with the specifications.

All pipe furnished for main sewer and service line installations shall be of the type, kind, size, and class indicated for each particular line segment as shown in the Plans and designated in the Contract Items. Wherever connection of dissimilar materials or designs is required, the method of joining and any special fittings employed shall be products specifically manufactured for this purpose and subject to approval by the Engineer.

Any pipe connections without manufactured bell-and-spigot ends must use rubber couplings with a .012 Thick, 300 Series Stainless Steel Shear Ring as well as a concrete collar with a four (4") inch minimum thickness around and overlapping the entire coupler and shear ring by four (4") inches on either side, unless otherwise approved in writing by Engineer.

### B. Vitrified Clay Pipe and Fittings

Vitrified clay extra strength pipe and fittings shall conform to the requirements of ASTM C-700 for the size and type and class specified, subject to the following supplementary provisions:

Unless otherwise specified, the pipe and fittings shall be non-perforated, full circular type, either glazed or unglazed.

All pipe and fittings manufactured with bell-and-spigot ends shall be furnished with factory fabricated compression joints conforming to the requirements of ASTM C-425.

All clay pipe fittings (wyes, tees, bends, plugs, etc.) shall be of the same pipe class and joint design as the pipe to which they are to be attached.

### C. Ductile Iron Pipe and Fittings

The pipe furnished shall be Ductile Iron pipe and fittings furnished shall be of the Ductile Iron type as specified for each particular use of installation. Gray Iron may not be substituted for Ductile Iron unless specifically authorized in the Special Provisions.

Ductile iron pipe shall conform to the requirements of AWWA C115 or C151 for water and thickness design shall conform to AWWA C150. In addition, the pipe shall comply with the following supplementary provisions:

Fittings shall conform to the requirements of AWWA C110 OR 153 (Gray Iron and Ductile Iron Fittings or Ductile Iron Compact Fittings) for the joint type specified.

Unless otherwise specified, all pipe and fittings shall be furnished with cement mortar lining meeting the requirements of AWWA C104 for standard thickness lining. All exterior surfaces of the pipe and fittings shall have an asphaltic coating at least one mil thick, or an approved equivalent. Spotty or thin seal coating, or poor coating adhesion, shall be cause for rejection.

Rubber gasket joints for Ductile Iron Pressure Pipe and fittings shall conform to AWWA C111.

Conductivity, when required by the Special Provisions, shall be maintained through pipe and fittings with an external copper jumper wire or specialty gaskets which are capable of meeting conductive requirements. Wedge type connectors will not be allowed.

#### D. Reinforced Concrete Pipe and Fittings

Reinforced concrete pipe, fittings and specials shall conform to the requirements of ASTM C-76 (Reinforced Concrete Pipe) with rubber O-ring or profile joints for the type, size, and strength class specified, subject to the following supplementary provisions:

All branch fittings such as tees, wyes, etc. shall be cast as integral parts of the pipe. All fittings and specials shall be of the same strength class as the pipe to which they are attached.

Joints shall meet the requirements of ASTM C-361 and ASTM C443.

Lift holes will not be permitted unless approved by the Engineer. If lift holes are permitted, then all lift holes shall be plugged and made water tight from the exterior prior to placement of any backfill. The lift hole plug shall be finished smooth to the interior of the pipe.

#### E. Corrugated Steel Pipe and Fittings

Corrugated steel pipe and fittings are not acceptable for use.

#### F. Polyvinyl Chloride Pipe and Fittings

Polyvinyl chloride pipe and fittings shall be used for sewers and drains subject to the approval of SWS Operations. Smooth walled polyvinyl chloride pipe and fittings shall conform to the requirements of ASTM D-3034 and ASTM F-679 for the size, standard dimension ratio (SDR), and strength requirements indicated on the Plans, Specifications, and Special Provisions. The grade used shall be resistant to aggressive soils or corrosive substances in accordance with the requirements of ASTM D-543.

Unless otherwise specified, all pipe and fittings shall be a minimum thickness of SDR-26 and connections shall be push-on with elastomeric gasket joints which are bonded to the inner wall of the gasket recess of the bell socket meeting the requirements of ASTM D-3212.

Sewer service pipes less than 10" diameter shall be Schedule 40 or greater with solvent cement joints and shall conform to the requirements of ASTM D1785 and ASTM D2665.

Corrugated polyvinyl chloride pipe and fittings shall be used for sewers and drains subject to the approval of SWS Operations. Corrugated polyvinyl chloride pipe and fittings with smooth interior shall conform to the requirements of ASTM F-949 for the size and wall thickness indicated on the Plans, Specifications, and Special Provisions. Unless otherwise specified, all pipe and fittings shall be push-on with snug fit elastomeric joints meeting tightness requirements of ASTM D-3212 and ASTM F-477.

#### G. Cast Iron Soil Pipe

Cast Iron Soil Pipe is not acceptable for use.

#### H. Acrylonitrile-Butadiene-Styrene Pipe

Acrylonitrile-Butadiene-Styrene pipe and fittings are not acceptable for use.

#### I. Dual-Wall Corrugated Polyethylene Pipe

Dual-Wall Corrugated Polyethylene Pipe, where permitted in the plans shall conform to the requirements of AASHTO M-294 and Design 18 of the AASHTO Standard Specifications for Highway Bridges for storm sewer pipe sizes 12-inch through 36-inch. Joints shall be bell and spigot push-on type, soil-tight and water-tight joints in accordance with ASTM D3212 and ASTM F477. Pipe manufacture, water-tight joint testing, and installation shall conform to current MnDOT requirements and/or as indicated in the Plans, Specifications, and Special Provisions.

#### J. Corrugated Aluminum Pipe

Corrugate Aluminum pipe is not acceptable for use.

#### K. Corrugated Aluminized Steel

Corrugated aluminized steel pipe is not acceptable for use.

#### L. Polymeric Coated Corrugated Steel

Polymeric Coated Corrugated Steel is not acceptable for use.

#### M. Tracer Wire for Non-conductive Pipe

Tracer wire shall be installed along the length of all non-conductive mainline pipe, laterals, and services with vertical riser to the surface, at manholes, catch basins, stubs, laterals, services, and/or utility location boxes as required by the Special Provisions or the SWS Operations Engineer.

### (2503.3) Construction Requirements

#### A. Inspection and Handling

Proper and adequate implements, tools, and facilities satisfactory to the Engineer shall be provided and used by the Contractor for the safe and convenient prosecution of the work. During

the process of unloading, all pipe and accessories shall be inspected by the Contractor for damage. The Contractor shall notify the Engineer of all material found to have cracks, flaws or other defects. The Engineer will inspect the damaged materials and have the right to reject any materials found to be unsatisfactory. The Contractor shall promptly remove all rejected material from the site, and replace all rejected material at no additional expense to the Owner. All materials shall be handled carefully, as will prevent damage to protective coatings, linings, and joint fillings; preclude contamination of interior areas; and avoid jolting contact, dropping, or dumping.

All work and materials are subject to tests by the Owner at such frequency as may be determined by the Engineer.

While suspended and before being lowered into laying position, each pipe section and appurtenant unit shall be inspected by the Contractor to detect damage or unsound conditions that may need corrective action or be cause for rejection. The Contractor shall inform the Engineer of any defects discovered and the Engineer will prescribe the required corrective actions or order rejection.

Immediately before placement, the joint surfaces of each pipe section and fitting shall be inspected for the presence of foreign matter, coating blisters, rough edges or projections, and any imperfections so detected shall be corrected by cleaning, trimming, or repair as needed.

#### B. Pipe Laying Operations

All foreign matter or dirt shall be removed from the inside of the pipe and fittings before they are lowered into position in the trench and they shall be kept clean by approved means during and after laying. The sewer materials shall be carefully lowered into laying position by the use of suitable restraining devices. Under no circumstances shall the pipe be dropped into the trench.

At the time of pipe placement, the bedding conditions shall be such as to provide uniform and continuous support for the pipe between bell holes. Bell holes shall be excavated as necessary to make the joint connections, but they shall be no larger than would be adequate to support the pipe throughout its length. No pipe material shall be laid in water or when the trench or bedding conditions are otherwise unsuitable or improper.

When placement or handling precautions prove inadequate, in the Engineer's opinion, the Contractor shall provide and install suitable plugs or caps effectively, closing the open ends of each pipe section, before the pipe is lowered into laying position. The pipe ends shall remain so covered until removal is necessary for connection of an adjoining unit.

Unless otherwise permitted by the Engineer, bell and spigot pipe shall be laid with the bell ends facing upgrade and the laying shall start on the downgrade end and precede upgrade. As each length of bell and spigot pipe is placed in laying position, the spigot end shall be centered in the bell and the pipe forced home and brought to correct line and grade. The pipe shall be secured in place with approved backfill material, which shall be thoroughly compacted by tamping around the pipe to a height of at least 12 inches above the top with hand operated mechanical tamping devices or by hand. The joint areas shall remain exposed and precautions shall be taken to

prevent the soil from entering the joint space, until the joint seal is affected. Backfill in the bell area shall be left loose.

Connection of pipe to existing lines or previously constructed manholes or catch basins shall be accomplished as shown in the Plans or as otherwise approved by the Engineer. Where necessary to make satisfactory closure or produce the required curvature, grade or alignment deflections at joints shall not exceed that which will assure tight joints and comply with any limitations recommended by the pipe manufacturer.

Entrance of foreign matter into pipeline openings shall be prevented at all times to the extent that suitable plugs or covering can be kept in place over the openings without interfering with the installation operations.

Installation of thermoplastic pipe shall conform to ASTM D-2321.

Installation of vitrified clay pipe shall conform to ASTM C12.

Installation of ductile iron pipe shall conform to AWWA C600.

#### C. Connection and Assembly of Joints

All pipe and fitting joints shall fit tightly and be fully closed. Spigot ends shall be marked as necessary to indicate the point of complete closure. All joints shall be soil tight and water tight.

#### D. Connection of All Pipes

All new or existing structures are required to have a precast connection point manufactured by the vendor or be core drilled when connecting all sewer pipe. The structures to which these connections are made include but are not limited to mainline pipe, manholes, catch basins, box culverts, and grit chambers.

Wherever connections to the main sewer are permitted or required to be made in the absence of an existing built-in Tee or Wye Fitting, the connection points are required to be core drilled and the connection shall be made by using an approved type of Wye fitting, Tee Insert, Boot fitting, or Saddle Tee, subject to approval of SWS Operations.

When core drilling, the pipe cut-out shall be made with an approved type coring machine or by other approved methods producing a uniform, smooth circular cut-out as required for proper fit. Other methods such as by hand sawing or blunt force shall not be allowed in the creation of a connection point.

New manholes to be placed at the connection point of the main shall be submitted to the Surface Water & Sewers Engineer (612-673-5627) for review and approval prior to the start of construction.

#### E. Bulkheading Open Pipe Ends

All pipe and fitting ends, left open for future connection, shall be bulkheaded by approved methods prior to backfilling. Unless otherwise specified or approved, all openings of 24 inches in diameter or less shall be closed off with prefabricated plugs or caps and all openings larger than 24 inches in diameter shall be closed off with masonry bulkheads.



Prefabricated plugs and caps shall be of the same material as the pipe material, or an approved alternate material, and they shall be installed with watertight seal as required for the pipeline joints. Masonry bulkheads shall be constructed with clay or concrete brick to a wall thickness of eight inches.

Bulkheads installed for temporary service during construction may be constructed with two- inch timber planking securely fastened together and adequately braced, as an alternate to the masonry construction.

#### F. Appurtenance Installations

Appurtenance items such as aprons, trash guards, gates and castings shall be installed where and as required by the Plans and in accordance with such standard detail drawings or supplementary requirements as may be specified.

Sewer aprons shall be subject to all applicable requirements for installation of pipe. All aprons and outfall end sections shall have the last three sections tied. Two tie bolt fasteners shall be placed in each of the last three joints, one on each side of top center at the 60 degree point (from vertical). Tie bolt diameter shall be: 5/8 inch for 12" to and including 27" pipe; 3/4 inch for 30" to and including 54" pipe; and 1" for 60" and larger pipe. The tie bolts shall be of a design approved by the Engineer.

#### G. Sewer Service Installations

Main sewer service connections and building service sewer pipe shall be installed as provided for in the Contract and as may be directed by the Engineer. The sewer service connections and pipe lines shall be installed in conformance with all applicable requirements of the main sewer installation and as more specifically provided for herein.

The Engineer, with the assistance of the Contractor, shall keep accurate records of all service installations as to type, location, elevation, point of connection and termination, etc. This service record shall be maintained by the Contractor and approved by the Engineer. The service installations shall not be backfilled until all required information has been obtained and recorded, and all necessary City inspections have been completed. A copy of the service record shall be given to the City at the time of the inspection.

The standard and minimum grades shall be a uniform rise of one inch in four feet for sanitary service lines and one inch in eight feet for storm service lines. These minimum grades may be reduced subject to the approval of SWS Operations.

Building service pipe lines shall generally be kept as deep as required to serve the building elevation and maintain the specified minimum pipe grades. Pipe bends shall be provided as necessary to bring the service lines to proper location and grade. Pipe bends in the right of way shall not exceed 22-1/2 degrees without approval of the Engineer.

Unless otherwise indicated, service pipe installation shall terminate at property line or as designated on the Plans, with a gasket plug placed in the end.

Wherever service line connections to the main sewer are permitted or required to be made in the absence of an existing built-in Tee or Wye fitting, the connection shall be made by using an approved type of Wye fitting, Saddle Tee, Tee Insert, or Boot fitting, subject to approval of SWS Operations. The pipe cut-out shall be made with an approved type coring machine or by other approved methods producing a uniform, smooth circular cut-out as required for proper fit. Other methods of making a pipe cut-out, such as hand sawing or blunt force shall not be allowed in the creation of a connection point. The cut-out discs shall be retrieved and shall not be allowed to remain within the main sewer pipe. The Saddle Tee shall be securely fastened to the main sewer pipe by means stainless steel clamps. The entire connection fitting shall be encased in concrete to a minimum thickness of six inches and as may be shown in the standard drawings. No part of the saddle may protrude into the main sewer. Orientation of service connection fitting shall be as shown in the standard drawings unless otherwise directed by the Engineer.

Wherever service line connections to the main sewer are permitted or required to be made in the absence of an existing built-in Branch Tee or Wye fitting, the connection shall be made by removing a section of the main sewer pipe and replacing it with the required Branch Tee or Wye section subject to the approval of the Engineer. The Branch Tee or Wye fitting shall be of the same material and thickness as the pipe being connected to and connected by means of an approved sleeve coupling.

Sanitary sewer service lines shall not be connected to a manhole at an elevation more than 24 inches above the crown of the outgoing sewer.

All pipe and fitting openings at temporary terminal points shall be fitted with suitable plugs or shall be bulk headed as required for the main sewer pipe.

#### H. Abandonment and Reconnecting Existing Facilities

All sanitary and storm sewer lines abandoned as part of a project within the City right-of-way are to be completely removed by the Contractor. Bulkheads shall be installed at both the inlet and outlet of the pipe to be removed, at the correlating manholes.

If approved by the Engineer in lieu of removals, pipes must be completely filled with a cement slurry material approved by the Engineer. Before placement of the cement slurry, the inlet and outlet of the line to be abandoned shall have bulkheads installed.

#### I. Sanitary Sewer Leakage Testing

All sanitary sewer lines, including service connections, shall be substantially watertight and shall be tested for excessive leakage upon completion and before connections are made to the service by Others. Each test section of the sewer shall be subjected to exfiltration testing, either by hydrostatic or air test method as described below and at the Contractor's option. The requirements set forth for maximum leakage shall be met as a condition for acceptance of the sewer section represented by the test.

If the ground water level is greater than three feet above the invert elevation of the upper manhole and the Engineer so approves, infiltration testing may be allowed in lieu of the exfiltration testing, in which case the allowable leakage shall be the same as would be allowed for the Hydrostatic Test.

All leakage testing shall be performed by the Contractor without any direct compensation being made, and the Contractor shall furnish all necessary equipment and materials, including plugs and standpipes as required.

#### J. Air Test Method

The pipeline shall be sealed with plug whose sealing length is greater than the diameter of the pipe and constructed in such a nature that it will not require external blocking or bracing and maintain a seal against the line's test pressure.

All wyes, tees, outlets or ends of lateral streets shall be suitably capped and braced to withstand the internal pressures. Such caps or plugs shall be easily removable.

One plug shall be tapped for the air supply hose and the return air pressure hose. The air supply hose, connected from the compressor to the plug shall be a throttling valve, bleeding valve and shut off valve for control. The air pressure tap shall have a sensitive pressure gauge, 0 to 10 psi range, protected by a gauge cock and a pressure relief valve set at 10 psi.

In performing the test, air is added slowly to the pipeline until pressure inside the pipeline reaches 4.0 psi. If air is added too rapidly, the test accuracy will decrease because a change in temperature also has an effect on the change in pressure. When the air pressure inside the pipeline reaches 4.0 psig above external hydrostatic pressure, the supply air is stopped. A minimum two-minute time interval is allowed for the temperature difference to stabilize before the actual test is performed. If the air pressure drops below 3.5 psig during this time interval, more air will be supplied to the pipeline and throttled to maintain a pressure between 3.5 psig and 4.0 psig for a minimum of two minutes after which time the supply air will be shut off.

The portion of line being tested shall be accepted if the portion under test does not lose air at a rate greater than 0.0015 cfm per square foot (for PVC) or 0.003 cfm per square foot (for RCP) per internal pipe end area at an average pressure of 3.0 psig greater than any back pressure exerted by groundwater that may be over the pipe at the time of test.

The test shall be accomplished by determining the time in minutes for the pressure to decrease from 3.5 psig to 3.0 psig greater than the average groundwater that may be over the pipe for PVC and RCP pipe. Test times are for a 3.5 to 2.5 psi pressure drop for VCP. Testing for VCP shall be in accordance with ASTM C828.

That time shall not be less than the time shown on the given diameter in the following table:

<b>Pipe Diameter in Inches</b>	<b>Minutes for PVC</b>	<b>Minutes for RCP</b>	<b>Minutes for VCP</b>
4	1.9	1.0	0.3
6	2.8	1.4	0.7

8	3.8	1.9	1.2
10	4.7	2.4	1.5
12	5.7	2.9	1.8
15	7.1	3.4	2.1
18	8.5	4.3	2.4
21	9.9	5.0	3.0
24	11.3	5.7	3.6

If the pipeline fails to meet the requirements of the test, the Contractor shall, at their own expense, determine the source of leakage and then repair or replace all defective material and/or workmanship.

In determining the pressure greater than the average groundwater, the groundwater height in feet above the pipeline must be measured.

When the water elevation has been established, the height in feet above the pipeline shall be divided by 2.31 and that pressure added to gauge pressure of test.

A table for converting water height to gauge pressure is as follows:

Groundwater Level over Top of Pipeline	Added Pressure to be Applied to Gauge Pressure Readings
1 foot	0.43 psig
2 feet	0.86 psig
3 feet	1.29 psig
4 feet	1.72 psig
5 feet	2.16 psig
6 feet	2.59 psig
7 feet	3.01 psig
8 feet	3.44 psig
9 feet	3.87 psig
10 feet	4.30 psig

#### K. Hydrostatic Test Method

After bulk heading the test section, the pipe shall be subjected to a hydrostatic pressure produced by a head of water at a depth of three feet above the invert elevation of the sewer at the manhole of the test section. In areas where ground water exists, this head of water shall be three feet above the existing water table.

The water head shall be maintained for a period of one hour during which time it will be presumed that full absorption of the pipe body has taken place, and thereafter for an extended period of one hour the water head shall be maintained as the test period. During the one hour test period, the measured water loss within the test section, including service stubs, shall not exceed the Maximum Allowable Loss (in Gallons Per Hour per 100 Feet of Pipe) given below for the applicable Main Sewer Diameter.

Main Sewer Diameter (In Inches)	Maximum Allowable Loss (In Gallons per Hour Per 100 Feet)
6	0.5
8	0.6
10	0.8
12	1.0
15	1.2
18	1.4
21	1.7
24 & Larger	1.9

\*Based on 100 Gallons per Day per Pipe Diameter Inch per Mile

If measurements indicate exfiltration within a test action section is not greater than the allowable maximum, the section will be accepted as passing the test.

#### L. Test Failure and Remedy

In the event of test failure on any test section, testing shall be continued until all leakage has been detected and corrected to meet the requirements. All repair work shall be subject to approval of the Engineer. Introduction of sealant substances by means of the test water will not be permitted.

Unsatisfactory repairs or test results may result in an order to remove and replace pipe as the Engineer considers necessary for test conformance. All repair and replacement work shall be at the Contractor's expense.

#### M. Deflection Test

Deflection tests shall be performed on all plastic gravity sewer pipes. The test shall be conducted after the sewer trench has been backfilled to the desired finished grade and has been in place for 30 days.

The deflection test shall be performed by pulling a rigid ball or nine-point mandrel (MnDOT Technical Memorandum 98-24-B-01 or latest revision) through the pipe without the aid of mechanical pulling devices. The ball or mandrel shall have a minimum diameter equal to 95% of the actual inside diameter of the pipe. The maximum allowable deflection shall not exceed five percent of the pipe's internal diameter. The line will be considered acceptable if the mandrel can progress through the line without binding. The time of the test, method of testing, and the equipment to be used for the test shall be subject to the approval of the Engineer.

All testing shall be performed by the Contractor at his expense without any direct compensation being made therefore, and he shall furnish all necessary equipment and materials required.

#### N. Test Failure and Remedy

In the event of test failure on any test section, the section shall be replaced, with all repair work subject to approval of the Engineer. The replaced section shall be retested for leakage and deflection in conformance with the specifications contained herein. All repairs, replacement, and retesting shall be at the Contractor's expense.

**O. Televising**

If visual inspection, leakage testing, or deflection testing indicate the sewer has not been constructed to specification, sewer line televising may be required by the Engineer. At the Engineer's discretion, the Engineer may require televising in lieu of testing. No additional compensation will be made by the City for sewer line televising that is required due to unsatisfactory inspection or test results.

The Engineer may require televising of the sewer lines to ensure the line is free from construction debris. No additional compensation will be made by the City for the sewer line televising or subsequent pipe cleaning activities that may be required for debris removal.

**P. Concrete and Masonry work**

All masonry mortar and concrete shall be mechanically mixed for the length of time recommended by the manufacturer. Mortar or concrete shall not be mixed by hand unless approved on a case by case basis by the Engineer. See S-27 for material requirements.

All newly placed concrete and masonry shall be protected against freezing to allow for proper cure. In addition, any concrete or masonry installed after October 1<sup>st</sup>, and before April 15<sup>th</sup> will require an approved cold-weather concrete/masonry plan prior to any work starting. This plan must be approved by the Engineer.

**(2503.5) Basis of Payment**

The contract unit price for constructing and reconstructing Drainage Structures and Sewer Pipe of each size, type, kind, and strength class include the costs of excavation, preparation of trench, providing, and installing the pipe complete-in-place as required by the contract.

**S-27 (2506) MANHOLES AND CATCH BASINS**

For the purpose of these Standard Supplemental Specifications MnDOT 2506 shall govern, except with the following modifications and amendment(s):

**(2506.2) Materials**

Unless otherwise specified or approved, manholes and catch basins shall be constructed on a precast or cast-in-place concrete base and the barrel riser sections, cone section and top adjusting rings shall all be of precast concrete. All units shall be properly fitted and sealed to form a completely watertight structure.

Shallow structures may require that the structure be precast with an over depth and the over depth sump filled in with cement grout to satisfy this requirement. This over depth and grout shall be considered incidental.

**(2506.3) Construction Requirement**

#### A. General

Steps shall not be provided in any City drainage structure.

Connections made to manholes with sewer main require waterproof connections. For precast sections that are monolithic, a waterproof boot shall be used to provide such connection. As shown on the plans or directed by the Engineer, all other connections made to manholes or catch basins that are constructed with sewer brick or block require the use of a rubber water-stop that shall be placed on the pipe at the area where the constructed connection is made.

Inlet and outlet pipes shall extend through the walls of the structure being connected to and shall be trimmed flush with the inside wall, or as otherwise directed by the engineer.

The shaped concrete fill invert for all manhole types shall be a Power Flow according to Public Works Standard Plates and extend up to two thirds of the diameter of the connecting pipe.

All sanitary and storm manholes to be abandoned are to be completely removed by the Contractor. In lieu of completely removing the structure, the Contractor may abandon the structure in place if approved by the Engineer. Abandonment of a manhole includes installing bulkheads in all inlet and outlet pipes in the structure by previously described methods. In addition, the top five (5) feet of the structure from finished grade must be removed. Any part of the structure that remains below the top five (5) feet must be filled with an approved material and compacted to meet density requirements of MnDOT Specification 2105.

If the build height of a CB structure is (48) inches or greater from the invert of the outgoing pipe (or bottom of the sump) to the top of the CB grate, a (48) inch diameter or larger riser section shall be used.

#### B. Cast-in-Place Concrete

Concrete for cast-in-place masonry construction shall be produced and furnished in accordance with the requirements of MnDOT Specification 2461 for the mix designation indicated in the Plans. The requirements for Grade B concrete shall be met where a higher grade is not specified. Type 3 (air-entrained) concrete shall be furnished and used in all structures having weather exposure.

Concrete cast-in-place base shall be poured on undisturbed or firmly compacted foundation material which shall be trimmed to proper elevation. The concrete base under an outside drop connection shall be monolithic with the manhole base.

#### C. Sectional Concrete

Precast concrete riser sections and appurtenant units (grade rings, top and base slabs, special sections, etc.) used in the construction of manhole and catch basin structures shall conform with the requirements of ASTM C-478, Minneapolis Public Works Standard Plates, MnDOT 2506 and the following supplementary provisions:

- (1) Joints of manhole riser sections shall be tongue and groove and gasketed in accordance with ASTM C443.

- (2) A Certificate of Compliance shall be furnished with each shipment of precast manhole and catch basin sections stating that the materials furnished have been tested and are in compliance with the specification requirements.
- (3) Only keyed lift holes will be permitted in precast manholes.

#### D. Castings

Manhole castings shall be removed from structures prior to the full depth bituminous paving operation and the structure openings covered with rigid steel plates. Before the wearing course is placed, the castings shall be set in mortar to the final road elevation. Asphalt pavement removed for the manhole adjustment shall be replaced in kind. The cost for the replaced asphalt material shall be incidental to the Contract with no direct compensation made therefore.

For castings placed in concrete pavements, all costs associated with the installation of reinforcing steel, as required by the Minneapolis Public Works Standard Plates, shall be incidental to the Contract with no direct compensation made therefore.

#### E. Adjusting Frame or Ring Casting

Minimum thickness of each adjusting ring shall be (2) inches.

A maximum of three (3) and a minimum of one (1) concrete adjusting ring is required. All rings shall have a minimum ½ inch of an approved mortar placed in between the casting, the adjusting ring(s) and the top of the structure. No dry stacking shall be permitted.

A four (4") inch thick concrete encasement shall be placed around the outside of the manhole or catch basin adjusting rings as detailed in current Public Works Standard Plates. This encasement shall be placed at the time of final casting placement and shall be incidental for which no payment will be made.

The shaped concrete fill invert for all manhole types shall be a Power Flow according to Public Works Standard Plates and extend up to two thirds of the diameter of the connecting pipe.

Inlet and outlet pipes shall extend through the walls of the structure being connected to and shall be trimmed flush with the inside wall, or as otherwise directed. Masonry blocks shall not be set with a joint width less than 3/8 inch to assure that vertical joints are completely filled with mortar.

Segmental concrete masonry units (block, brick, adjusting rings) used in the construction of the catch basins, manholes, and other drainage structures shall conform to ASTM C139, except that the cement used shall be Type II (moderate sulfate resistant), the compressive strength (average of three units) shall be 5,000 psi with the minimum of any one block being 4,500 psi, and the maximum absorption (average three units) shall be 5.5% by weight with the maximum of any one block being 6.0% by weight. Class C fly ash or other approved pozzolan shall be substituted for 15% on a pound for pound basis by weight of the designed Portland Cement. In lieu of the Type II cement with 15% Type C fly ash, Type 1.P cement may be used.

Concrete for cast-in-place masonry construction shall be produced and furnished in accordance with the requirements of MnDOT Specification 2461 for the mix designation indicated in the



Plans. The requirements for Grade B concrete shall be met where a higher grade is not specified. Type 3 (air-entrained) concrete shall be furnished and used in all structures having weather exposure.

Mortar shall conform to ASTM C 270. The mortar shall be composed of 3 to 4 parts of Portland cement to 1 part of Type S hydrated lime. Mortar sand shall have a volume equal to 2.25 to 3.5 times the total of the volume of cement and lime. Sufficient water shall be added for proper consistency. The cement and lime shall be air-entrained unless approved otherwise by the Engineer. The entrained air content of the mortar shall be within the range of 7-10 percent.

Metal castings for sewer structures such as manhole frames and covers, catch basin frames, grates and curb boxes, shall conform to the requirements of ASTM A-48 (Gray Iron Castings), subject to the following supplementary provisions:

Casting assemblies or dimensions, details, weights, and class shall be as indicated in the detailed drawings for the design designation specified. Unless otherwise specified, the castings shall be Class 30 or better.

Lid-to-frame surfaces on round casting assemblies shall be machine milled to provide true bearing around the entire circumference.

Casting weight shall be not less than 95 percent of theoretical weight for a unit cast to exact dimensions, based on 442 pounds per cubic foot.

A Certificate of Compliance shall be furnished with each shipment of castings stating that the materials furnished have been tested and are in compliance with the specification requirements.

Storm sewer manhole covers shall conform to City Standard Plate SEWR-2000 unless otherwise specified, sanitary sewer manholes in areas subject to flooding by surface water shall have self-sealing covers and recessed pick holes and conform to City Standard Plate SEWR-2001.

Unless otherwise specified, sanitary sewer manhole covers shall have recessed pick holes and conform to City Standard Plate SEWR-2001.

Gray Iron castings shall be supplied by foundries that have been approved by the State Materials Engineer.

Casting assemblies installed on manhole or catch basin structures shall be set in a full mortar bed and be adjusted to the specified elevation without the use of shims or blocking. Mortar shall be applied to the outside of the casting between casting and structure as well as around any adjusting rings according to Public Works Standard Plates.

The maximum total height of adjustment on any newly constructed manhole shall be eight (8") inches. Adjustments over eight (8") inches shall not be permitted. The Contractor shall not use steel adjusting rings on newly constructed manholes.

Manhole castings in a bituminous overlay project shall be adjusted prior to placement of the wearing course. The Contractor may use cast iron adjusting rings where appropriate. Should the adjustment require, or the Contractor chooses removal of the pavement section around the casting, the pavement shall be replaced in kind. The cut around the casting shall be neat and the edges tacked prior to placing the asphalt. Should the adjustment prior to placement of the wearing course produce an unacceptable adjustment, the Contractor shall readjust the casting.

Unless otherwise specified or approved, manholes and catch basin manholes shall have an inside barrel diameter at the bottom of forty-eight (48”) inches minimum and the inside diameter at the top of the cone section and all adjusting rings shall be the same size and shape as the casting frame. Catch basins shall have an inside diameter of thirty (30”) inches and all adjusting rings shall be the same diameter of the casting frame. Casting assemblies shall be as specified in the Plans. Catch basin grate elevations shall be adjusted as necessary to maintain the required dip below normal gutter grade or as shown on the plans.

Wherever special designs so require or permit, and as otherwise may be approved by the Engineer, a precast concrete base may be used or the structure may be constructed with cast-in-place concrete. Cast-in-place concrete will be allowed, and may be required, where it is impossible to complete the construction with standard precast manhole sections.

All annular wall space surrounding the in-place storm sewer pipes shall be completely filled with mortar or concrete, and the inside bottom of each manhole and catch basin shall be shaped with a Power Flow as shown on Public Works Standard Plates to form a free flow through invert troughs.

Backfilling operations will not commence until all mortar has a minimum of 24 hours for curing. Any exception to this specification needs to be approved by the City in advance of the work being done.

### **S-28 (2511) RIPRAP**

Section 2511 is hereby supplemented and amended by the following:

Filter fabric shall be Type III or Type IV, MnDOT Specification 3733, as appropriate

### **S-29 (2521) WALKS**

*Supplement MnDOT Section 2521 with the following:*

#### (2521.3C1) ADA pedestrian ramps

American With Disabilities Act (ADA) pedestrian ramps shall be installed to the required Minnesota Department of Transportation American With Disabilities Act Requirements, for the Use of Truncated Domes/Detectable Warning Systems for Pedestrian Curb Ramps. Proper use of approved materials is also required meeting current MNDOT Materials for this work. **Pedestrian ramps will be constructed at all sidewalk intersections.** The Engineer will determine the location of pedestrian ramps.

All non-ADA compliant pedestrian ramps impacted by construction activities shall be upgraded to ADA compliant pedestrian ramps. Beginning in 2021, the contractor will be required to provide additional MNDOT ADA certification cards, which is defined in other sections of these specifications.

Prior to pouring curb and gutter at sidewalk intersections, verify the zero-height curb, curb transitions heights and proposed gutter flow lines to ensure drainage is maintained away from proposed pedestrian ramps as well as that the existing drainage patterns, including existing gutter inflows/outflows, are preserved.

The acceptable materials used shall conform to those items on the MNDOT material web sites:

<http://www.dot.state.mn.us/products/detectablewarningsurfaces/detectablewarningsurfaces.html>

#### Name and date stamp marks

A stamp mark showing the name of the contractor and the full date (month, day, and year) of concrete placement is required. The stamp mark shall be impressed into the sidewalk, curb, curb and gutter, drive approach or alley. The stamp mark shall be made in at least one place in every fifty (50) lineal feet, or at the beginning and the end of the work if a lesser amount is constructed, or, in one place if only one section of concrete is constructed. Each drive approach shall be stamped in at least one place. The City Engineer shall approve the style, size of lettering and the manner of stamping.

For sidewalks that have the subgrade layer constructed with materials meeting 3149.2.B1. and the subgrade layer exceeds 6" in thickness MnDOT Dynamic Cone Penetrometer (DCP) will be utilized as a compaction testing method.

For development projects, the compaction of the aggregate base layer under sidewalks (meeting the requirements of 2211) will utilize MnDOT Dynamic Cone Penetrometer (DCP) as a compaction testing method.

#### Concrete work around existing trees

Concrete work around existing trees shall follow this guideline listed below:

Trees are a valuable resource in Minneapolis. As much care as possible must be taken to minimize the negative impact of construction activities to trees.

**Tree Roots:** No living trees shall be removed without written permission of the Minneapolis Park and Recreation Board (612) 499-9233, with the exception that any roots of such living trees that interfere with installing the sidewalk on proper grade and in accordance with tree ring requirements, shall be removed as part of the grading work. The contractor shall remove all roots within the area defined as six and one half (6-1/2) inches below the top of the new finished sidewalk grade, by severing them off cleanly with a sharp axe, or by grinding them off using a root grinding machine. Removal of roots larger than 2" requires inspection by MPRB Forestry (612)-499-9233

**Tree Rings:** When trees exist within the boulevard or at the back of the sidewalk tree rings must be installed in the public sidewalk adjacent to any tree closer than 18" from base of tree to normal sidewalk edge at ground level or where tree roots prevent installing a straight edge. See Standard Plate ROAD 4005, Tree Ring Installation Guide for more details.

**Tree Ring Depth:** The distance measured from the normal sidewalk edge to the point of the ring arc perpendicular to the base of the tree.

All tree ring depth dimensions assume that the remaining width of the sidewalk will be at least four feet.

**Tree Ring Chord Length:** All tree ring chord lengths will be a minimum of 6'. Maximum ring chord length will be 18' (approximately three typical sidewalk section lengths) for a large tree, or greater, if approved by the Sidewalk Inspector.

### **S-30 (2564) TRAFFIC SIGNS & DEVICES**

For the purpose of these Standard Supplemental Specifications MnDOT 2564 shall govern, except with the following modifications and amendment(s):

#### (2564.3) Stop boxes, cables, signs, and meter collars

If a contractor finds, when repairing or constructing a public sidewalk, that a "water stop box" is not at the proper grade or that the cap is missing, the contractor shall notify the City of Minneapolis Public Works Water Department at (612) 673-5600 or the City of Minneapolis Public Works Sidewalk Inspections office at (612) 673-2420. All stop boxes must be located and adjusted to grade by the contractor before placement of any concrete within the public right of way.

When sidewalks are to be poured adjacent to the curb, the City of Minneapolis Public Works Traffic and Parking Services Division shall be notified at (612) 673-5750 a minimum of twenty-four hours before pouring. Sign collars are to be placed by the contractor at the original location, per plan, or as designated in writing by the Traffic and Parking Services Division. Contractor must obtain the needed sign collars through the City of Minneapolis Traffic Stores (612-673-5752) or order directly from the City approved supplier using the City standard plate posted on the City website. Traffic assets such as parking meters, signs, precasts, posts that are damaged or destroyed during construction shall be charged to the contractor at the City's unit cost. All collars shall be placed in compliance with the City of Minneapolis Standard plates, which includes true vertical "plumb" position and flush with the top of the sidewalk. Adequate clearance shall be provided for access to the collar set screws. (See Standard plate TRAF-5060-R1 or latest revision found on Minneapolis' Standards and Specifications website: <http://www2.minneapoliismn.gov/publicworks/plates/index.htm>)

#### (3352) Minneapolis Sign Design Standard

Any signs installed on a roadway in Minneapolis shall adhere to the City of Minneapolis Sign Design Standard for all sign panels. Minneapolis Sign Designs and standards can be obtained by contacting the City of Minneapolis Public Works Traffic and Parking Services Division at (612) 673-5750

#### (3352) Removal of Minneapolis Signs

City of Minneapolis Public Works Traffic and Parking Services Division at (612) 673-5750 must be contacted 24 hours prior to the removal of any signs in the right of way.

## **S-31 (2571) PLANT INSTALLATION AND ESTABLISHMENT**

### 2571.2.K.2.b

If planting stock larger than 3" is installed the contractor shall provide an irrevocable letter of credit or post a refundable deposit of \$600.00 per tree, valid for the establishment period of 1 year/ caliper inch. Example 4" caliper stock = 4 year establishment period. In the event the tree develops more than 30% crown decline during the establishment period MPRB Forestry will replace the tree using the deposit. This does not include decline resulting from mechanical injury, or loss due to impact or vandalism. Unused deposits will be returned at the end of the establishment period. The establishment period will commence on the planting date.

## **S-32 (2572) PROTECTION AND RESTORATION OF VEGETATION**

### Tree Protection

#### 2572.3. A.1

Tree protection has two primary functions for all existing trees within a construction zone of any type: (1) to avoid physical damage from contact by equipment, materials, and activities; (2) to preserve roots and soil conditions in an intact and non-compacted state.

MPRB approved tree protection must be specified for all existing trees within construction limits that are to be retained. Tree Protection Plan and/or Landscaping Management Plan will be required of all major Site Plan Reviews and Construction projects within the City of Minneapolis. At the MPRB Forestry discretion, a Tree Protection Plan/Landscape Management Plan may be required for small projects due to extenuating circumstances.

Tree Protection Zone (TPZ) is a restricted area around the base of the tree with a minimum radius of 1 foot for each inch DBH (Diameter at Breast Height - the diameter of a tree measured at 4.5 feet above grade) enclosed by fencing.

The fence shall enclose the entire area of the TPZ of the tree(s) to be protected for the duration of the construction project.

Where a TPZ is limited by trees in pavement trunk protection (boards tied around tree trunk) shall be installed to protect against mechanical injury. The boards will reach from grade to 8' or height of lowest branches whichever is least.

For trees situated within a boulevard or near a sidewalk or driveway, only the planting strip and yard side of the TPZ shall be enclosed with the required protective fencing. Paved surfaces may be excluded from the TPZ. Modified Tree protection zones may be specified by MPRB Forestry based on specific site restrictions.(see Standard Plate FORE 0001)

All trees to be preserved shall be protected with four (4) foot high fencing. Fencing is to be mounted on heavy duty steel T-posts driven into the ground to a depth of at least one (1) foot, six (6) inches (18" minimum) and no more than eight (8) foot spacing, whenever feasible.

A weatherproof Tree Protection Zone sign shall be prominently displayed on each fence at 50-foot intervals (or wherever feasible) on the tree protection fencing. The sign shall be a minimum 8.5 inches by 11 inches

2752.3. A.5 - replace 2752-1 with MPRB supplement table

TREE SIZE	MINIMUM UNDISTURBED RADIUS	MINIMUM BORE DEPTH
Less than 3" diameter	3 feet	3 feet
3" through 8"	6 feet	3 feet
8" through 14"	8 feet	4 feet
Larger than 14"	10 feet	4 feet

Utility conduits shall be installed under or behind sidewalks and not in the boulevard between the sidewalk and curb, wherever possible. Handhole boxes shall be a minimum of 10' from any public tree.

### **S-33 (2573) STORM WATER MANAGEMENT**

This work will be done in accordance with the applicable Standard Specifications, these Special Provisions and the following:

The following is hereby added to MnDOT 2573.3 A.1

If the Contractor fails to provide a certified Erosion Control Supervisor for the Project, the Engineer shall issue a written order to the Contractor. The Contractor shall respond within 24 hours and provide the required Erosion Control Supervisor or be subject to a \$1,000.00 per calendar day deduct for noncompliance.

The Erosion Control Supervisor shall be aware of all the requirement of these Special Provisions, especially any involving (1717) National Pollutant Discharge Elimination System (NPDES) Permit.

The following is hereby added to MnDOT 2573.3 A.2:

- (10) Inlet protection installation
- (11) Riprap placement

If the Contractor or subcontractor(s) fails to provide the required certified installer(s), the Erosion Control Supervisor shall notify the Engineer. If either the Erosion Control Supervisor or the Engineer determines that one or more required certified installers have not been provided, the Contractor shall respond to the Engineer's notification within 2 days with the appropriately certified person(s) or provisionally certified person(s) or be subject to a \$500.00 per required installer per calendar day deduction for noncompliance.

**S-34 (2575) ESTABLISHING TURF AND CONTROLLING EROSION**

For the purpose of these Standard Supplemental Specifications MnDOT 2575 shall govern, except with the following modifications and amendment(s):

(2575.3) Grading Preparation Prior to Seeding

Soil preparations shall include placement of four (4) inches of Topsoil borrow (MnDOT 3877.2A) and use of salt resistant sod (MnDOT 3878.2C)

MnDOT 2575.3.K.1 is modified to increase the sod maintenance period to 60 calendar days.

**S-35 (2582) PERMANENT PAVEMENT MARKING**

For the purpose of these supplemental provisions, MnDOT 2582 shall govern, except with the following modifications and amendments:

**Crosswalk Markings**

Crosswalks markings shall adhere to Minneapolis standard continental (zebra) crosswalk blocks. All pedestrian crosswalk markings shall be traffic white and shall follow Minneapolis Standard Plate TRAF-7672-R3 or latest revision found on Minneapolis' Standards and Specifications website: <http://www2.minneapolismn.gov/publicworks/plates/index.htm>.

Pavement markings, as shown on the plan sheets, shall be paint, epoxy resin or preformed plastic.

1. White and yellow painted pavement markings shall be as described in MnDOT Specification 3591 high solids water-based traffic paint with drop-on glass beads per MnDOT Specification 3592.
2. Epoxy resin markings shall comply with MnDOT Specification 3590, epoxy resin pavement markings (free of toxic heavy metals).
3. Preformed thermoplastic pavement marking material shall be in accordance with MnDOT Specification 3356. Only Preformed thermoplastic markings listed on MnDOT's Approved/Qualified Products page for pavements markings shall be allowed for use.

The preformed plastic markings shall be installed so the surface of the marking material is below the surface of the adjacent pavement. This is accomplished by cutting grooves in the pavement to accept the preformed plastic markings.

**GROOVING BITUMINOUS PAVEMENT SURFACES FOR PREFORMED PAVEMENT MARKINGS.**

The preformed pavement markings are to be grooved into the existing bituminous pavement surfaces. **GRINDER-TYPE CUTTING HEADS CANNOT BE USED.** The goal of the grooving process is to protect the pavement markings from snowplow damage and ultimately extend the service life of the pavement markings. Grooving operations are incidental to permanent pavement marking operations.

The Contractor has the option to dry or wet groove the pavement while the roadway is open or closed to traffic. The groove must be cleaned completely prior to pavement marking application, using an air compressor with at least 185 CFM air flow and 120 PSI air pressure. The compressor must be equipped with a moisture and oil trap, and cannot have more than 50 feet of 3/4 inch ID hose between the compressor and the air nozzle. The air nozzle must have an inside diameter of 1/2 inch or greater.

1. Grooving Equipment

The grooving shall be performed by a self-propelled machine equipped with gang stacked diamond cutting blades mounted on a floating head with controls capable of providing uniform depth and alignment.

The cutting heads shall consist of stacked 1/8 inch to 3/8 inch wide diamond tipped cutting blades. The spacers between each blade must be such that the raise in the bottom of the finished groove between the blades is less than 25 percent of the groove depth. The resulting bottom of the groove shall have a fine corduroy finish. If a course tooth pattern is present, the Contractor shall increase the number of blades and/or decrease the thickness of the spacers on the cutting head.

The equipment shall be capable of grooving the total width of the groove in one pass or be capable of grooving uniform depths with multiple passes. The maximum number of passes is detailed below. If multiple passes are used, the ridge between passes shall be mechanically removed prior to groove cleaning and pavement marking application.

The equipment shall be capable of grooving double lines simultaneously or parallel lines to a uniform depth with two passes.

The equipment shall be self-vacuuming and leave the cut groove ready for pavement marking installation. Dry cut grooving, without a vacuum will only be allowed if markings run perpendicular to the roadway, such as Stop Bars. The pavement marking manufacturer shall approve the equipment and method used.

2. Grooves

The grooving shall be performed within the following tolerances. Failure to meet these tolerances will result in the suspension of work until the Contractor can demonstrate that these tolerances can be met to the satisfaction of the Engineer.

GROOVE WIDTH AND MAXIMUM NUMBER OF PASSES

<u>MARKING WIDTH</u>	<u>GROOVE WIDTH</u>	<u>MAX NUMBER OF PASSES</u>
4 INCHES	5" ± 1/8"	1
6 INCHES	7" ± 1/8"	1



**S-36 (3138) AGGREGATE FOR SURFACE AND BASE COURSES**

8 INCHES	9" ± 1/8"	1
12 INCHES	13" ± 1/8"	2
24 INCHES	25" ± 1/8"	3

Since pavements are irregular, the depth of the groove across the width may vary. To compensate for this the depth of the groove shall be measured from the bottom of the groove to a straight edge extended over the groove from the pavement surface opposite the pavement joint.

**FULL DEPTH GROOVE LENGTHS**

Full Depth Groove Length (broken line)	10 feet ± 3 inches
Tapers at end of each line	6 inches – 9 inches
Space between Double lines	4 inches ± ¼ inch

The groove shall be placed 2 inches ± 1 inch from the edge of joints or seams along edge or centerlines.

The contractor shall provide any required interim markings that are necessary. These interim markings shall be in compliance with the requirements contained in the Minnesota Manual on Uniform Traffic Control Devices. Field measuring, spotting and interim markings shall be considered to be incidental and no direct compensation shall be made.

**Performed Markings Shall Be Placed in Strict Compliance with Manufacturer’s Instructions.**

Payment for pavement markings installed at Contract prices per unit of material shall be compensation in full for all costs incurred in materials, traffic control, marking, installation, surface preparation, use of primers, in accordance to Contract documents or as approved by the Engineer.

**S-36 (3138) AGGREGATE FOR SURFACE AND BASE COURSES**

For the purpose of these Standard Supplemental Specifications MnDOT 3138 shall govern, except with the following amendments(s):

**(3138) Aggregate**

The only acceptable aggregate for use under this special provision shall be Class 5, 100% virgin material, unless written approval is granted by the City Engineer allowing the use of other aggregate materials.

**S-37 (3149) GRANULAR MATERIAL**

The provisions of MnDOT Spec 3149 are amended with the following:  
Salvage Bituminous shall not be used in any granular material.

**S-38 (3861) PLANT STOCK****Supplement**

A “Tree Planting Permit” shall be obtained for the planting of any tree on City owned property. All permits must be obtained before any tree planting work begins. Tree planting approved by MPRB through formal City Review shall constitute compliance. Application for a Tree Planting Permit shall be requested by contacting MPRB Forestry.

**Species selection and Diversity Guidelines**

No more than (5) trees per genera may be represented on one block.

Ex. 6 trees = min. 2 genera, 11 trees = min. 3 genera, 16 trees = min. 4 genera.

No more than five trees from the Asian Longhorn Beetle preferred host list may be represented on one block. (Birch, Buckeye, Maple, Elm, Planetree)

MPRB Forestry will furnish a list of overrepresented genera based on neighborhood. Selections in those genera should not be used.

**Tree Spacing**

Preferred tree spacing should equal the crown spread for the selected variety.

Minimum tree spacing should be  $\frac{3}{4}$  of the crown spread for the selected variety.

Ex. Anticipated Crown spread for variety = 40' x  $\frac{3}{4}$  = 30' (min. on center spacing between trees).

Minimum Clearances for Tree Placement	
Existing Element	Min. Distance from Tree OC
Curb	24"
<b>Building Facade</b>	<b>48"</b>
Bike Rack	<b>5'</b>
Newsrack, trash can , utility box	<b>5'</b>
Crosswalk	7'
Fire hydrant	10'
<b>Street light base</b>	12'
<b>Pedestrian level light base</b>	<b>10'</b>
Utility pole	<b>10'</b>
Pedestrian Walkway (through	6'

walk zone)	
Outer edge of an entrance or doorway	24”
Bus stop	clear of bus loading zone
Transit shelter	5’
Loading Zone	clear of loading zone (reviewed on a case-by-case basis)
Stop Sign, Traffic Signal	20’
Parking Meter	5’
Distance to cross street	40’ approaching corner, 20’ non-approaching corner
Distance to alleys and driveways	6’

## S-39 ROW TREE PLANTING

### ROW Tree Planting Typologies and Requirements

#### A. Continuous Open Boulevard - Highest Priority for Minneapolis Streetscapes

- a. With a goal of installing large growing canopy trees, new construction should include providing a minimum continuous open boulevard width of 8 feet. The recommended width for boulevard tree planting is at least 8.5 feet wide (face of curb to edge of sidewalk). The minimum width for any tree planting shall be 4.5 feet (face of curb to edge of sidewalk), widths from 4.5 feet to 5.4 feet (face of curb to edge of sidewalk) will be limited to small growing tree selections only.
- b. Continuous open boulevard width of not less than 5 feet is required for any tree planting (width less than 5 feet will limit species selection to small growing trees).
- c. Planted medians shall be a minimum of ten feet (face of curb to face of curb) for tree planting.
- d. Where Continuous Open Boulevards spaces are designed, the top 24 inches shall be viable soil (Topsoil conforming to MnDOT Table 3877-2 or MPRB Forestry approved equivalent).

#### B. Open Planting Spaces - Second Priority for Minneapolis Streetscapes

- a. Where design does not allow a Continuous Open Boulevard, Open Planting Spaces in hardscape should have a minimum opening of 125 square feet per tree, and a minimum width of 5 feet.
- b. Where Open Planting Spaces are designed, the top 24 inches shall be viable soil (Topsoil conforming to MnDOT Table 3877-2 or MPRB Forestry approved equivalent).

#### C. Engineered Root Space - Third Priority for Minneapolis Streetscapes

- a. Where Continuous Open Boulevards or Open Planting Spaces cannot be incorporated, an approved Engineered Root Space of 500 cubic feet per tree shall be required with a minimum serviceable opening of 5 feet by 5 feet. Engineered Root Space profile must have a minimum width of 5 feet, minimum depth of 3 feet, and maximum depth of 4 feet. Designs that include continuous engineered root zones and enhance stormwater infiltration are preferred. For the extent of the serviceable opening planting soil (Topsoil conforming to MnDOT Table 3877-2 or MPRB Forestry approved equivalent) shall be placed to a minimum depth of 24". Rock Based Structural Soil may not occupy the top 24" of any part of the serviceable opening.
- b. Tree grates are discouraged, but may be allowed with the mutual consent of MPRB Forestry and Minneapolis Public Works, and may only be approved in conjunction with Engineered Root Space. In all cases, continuous open boulevards and open planting space alternatives shall be considered prior to the approval of tree grates.
- c. Utilizing permeable pavement or pavers does not preclude the requirement for Engineered Root Space. Types of engineered root space include:
  - i. Structural Soil Types
 

Structural soils are compacted to support pavement and allow root growth through connected voids between particles. These soil types include:

    - 1. Rock Based Structural Soil
    - 2. Sand Based Structural Soil
    - 3. Or other approved structural soil mix
  - ii. Suspended Pavement Systems
 

Systems that suspend pavement and are filled with uncompacted planting soil

## S-40 RECORD DRAWING REQUIREMENTS

Record drawings are required for all construction projects that alter public infrastructure within the City of Minneapolis. These record drawings are used to update public infrastructure data in the City's Enterprise Spatial Database and for locating per Gopher State One Call and State Statutes. This data is used by government agencies and private sector entities to guide them in subsequent planning, maintenance and design processes.

The cost for preparing record drawings shall be incidental, unless otherwise stated in the form of a pay item in the Project Contract Documents or in an Inter-Agency Agreement. For projects where the Contractor is performing the as-built survey whether or not the Contractor also prepares the record drawings, no infrastructure shall be accepted by the City until record drawings have been submitted to and approved by the City. The Contractor shall be responsible for maintaining the infrastructure and for assisting with Gopher State One Call location requests for all infrastructure constructed on the project until all record drawings have been submitted, reviewed and accepted by the City.

For projects where the City is performing the as-built survey and preparing the record drawings, the Contractor shall provide redlines of the plan sheets that denote where construction deviated from the approved plans. The redlines shall include but are not limited to changes in locations of new infrastructure, how special details were constructed, how connections were made, and changes in structure diameters or dimensions.

## GENERAL

The Record Drawing Plans should consist of the design plans submitted, approved, and permitted for the construction project. The information shown shall reflect the actual construction completed under the permit with any and all deviations from the design plans.

Record drawings shall conform to Minneapolis Public Works CADD standards, which are available on the Public Works CADD Standards web page: <http://www2.minneapolismn.gov/publicworks/CADDstandards/index.htm>.

For further information contact the Public Works CADD Manager @ 612-673-3623 or email @ [jim.cleary@minneapolismn.gov](mailto:jim.cleary@minneapolismn.gov)

The following Electronic Map data is available from the City upon request:

- Building Numbers
- Centerlines/Street Names
- LIDAR
- Orthophotos
- Planimetric

The specific record drawing requirements for each type of public infrastructure are outlined below.

## ROADWAY FACILITIES

- A. Compliance of Newly Constructed Pedestrian Ramps with ADA Standards
  - a. Documentation of deficiencies in the newly constructed ramps

## SEWER (STORM DRAIN & SANITARY) FACILITIES

Any project altering or building sewer or storm drain infrastructure shall provide record drawings which accurately depict what was constructed for all sewer and storm drain facilities that the project installs, relocates, removes, or replaces to Surface Water and Sewer Design, Public Service Center, 250 South 4<sup>th</sup> St, Room 300 regardless of ownership of the facility. Record drawings shall include, but are not limited to the following items:

- A. The horizontal location of all work
- B. The final curb lines
- C. All invert elevations, structure elevations, sump elevations and finished grade
- D. Pipe size, length, invert elevations in and out, materials and pipe grades
- E. Manhole material, type (i.e., storm, sanitary, CBMH, etc.), size (dimensions), depth below invert (sump elevation), rim elevation, and cover type (see City Standard Plates)
- F. Catch basin material, casting elevation, sump elevation, size (dimensions), grate type (see City Standard Plates)
- G. Special details of work not covered by City Standard Plates, including dimensions and elevations of components within special drainage structures (control structures, junction vaults, etc.)
- H. Prior location of removed facilities
- I. Location and method of facilities abandoned in place
- J. Locations, elevations, and details of connections to existing system including connection type (boot, concrete collar, or other) and updates to special details if included in the construction plans
- K. Control information for coordinates and elevations
- L. Construction Date (Year and Month)
- M. Built by and Ownership information
- N. Private service connection or reconnection location and elevation at the main, address, size, length of new pipe installed, material, type, and permit number
- O. Stormwater BMP, locations, dimensions, and details
- P. Details of inside or outside drops
- Q. Coordinates and elevations at the corners of top slabs for any non-circular structures

The record drawing deliverable shall include tabulations and drawings. Specific requirements, including horizontal and vertical datum, for these items and samples of acceptable Record Drawing formats may be obtained from the City website.

The Field Locators Deliverable as described in the above-mentioned reference documentation shall be submitted to Surface Water and Sewers for review and approval no later than 30 days following completion of construction activities. The Final Deliverable shall be submitted to Surface Water and Sewers no later than 60 days following completion of construction activities. **For multi-year projects, the Field Locators Deliverable shall be submitted no later than 30 days following suspension of construction activities for that season, and the Final Deliverable shall be submitted no later than the end of the calendar year for any sewer work completed that year, whether project is incomplete or complete.**

## **STREET LIGHTING, TRAFFIC SIGNALS, TRAFFIC SIGNAL INTERCONNECT & FIBER OPTIC FACILITIES**

All as-built record drawings pertaining to City of Minneapolis streetlighting, traffic signals, signal interconnect and fiber optic facilities, or empty Traffic conduits installed for future use shall be performed by the City of Minneapolis Traffic Department. The contractor shall notify Nic Racek at 612-398-5295 or [Nic.racek@minneapolismn.gov](mailto:Nic.racek@minneapolismn.gov) prior to commencing work. The Traffic Division Record Drawing Group shall be notified of all project pre-construction meetings and construction progress meeting schedules as well as obtain contact info for contractor project manager and site foreman.

### **A. Electrical facility locating during construction**

Locating of newly installed underground electrical facilities or existing underground electrical facilities that are abandoned or designated for reuse, whether or not they have been documented or recorded, will be the electrical contractor's responsibility until final project acceptance.

## **WATER DISTRIBUTION FACILITIES**

All as-built record drawings, including gathering of survey data, pertaining to City of Minneapolis water distribution facilities will be handled by City Staff.

## **S-41 UTILITY AGREEMENTS, PERMITS AND ORDERS**

A. The City makes no warranty, express or implied; that the utility companies will relocate their facilities in accordance with the terms of any applicable Agreements, Permits or Orders

B. The Contractor may be required to work in and around utility properties and has considered this fact when preparing their proposals and estimates.

C. The above shall not be construed as being a modification of any of the Provisions of 1507.

## **S-42 CONCRETE PAVED STREETS RESTORATION**

These specifications govern the manner and extent of the restoration for city Portland cement concrete (PCC) streets impacted by utility cuts. These specifications apply to utility cuts that have the maximum area of less than one concrete panel. For PCC pavement projects that were constructed or rehabilitated within the last 5 years and/or larger restoration projects that involve multiple utility cuts or large continuous trenches a recommendation of the project specific restoration shall be determined by the City of Minneapolis.

The contractor shall warranty all restoration work (materials and workmanship), for a period of up to two years after the date stamp. The date stamp shall be placed on every individual concrete repair. This warranty shall include settlement or failure of the concrete restoration or base. Warranty work enforcement is subject to MCO Chapter 430. The guidelines for PCC pavement restoration are detailed below:

**Good pavement condition (as determined by the City) restoration requirement:**

**No New Joints.** If the existing PCC pavement exhibits distresses that are generally of low severity (this corresponds to roughly a Pavement Condition Index (PCI) of approximately 100-75) or where upon visual inspection there are little or no distresses in the pavement or joints failures, faulting or other typical surface defects, the level of restoration will be, No New Joints. This means all affected sections or panels will be replaced from original pavement joint to original pavement joint. Generally this entails placing 1" diameter dowels bar assemblies- 18" long @ 12" center to center along the transverse joints and placing/securing #4 tie bars-18" long @ 24" center to center along the longitudinal joints. The Pavement Condition Index (PCI) would be provided upon request.

**Fair pavement condition (as determined by the City) restoration requirement:**

**Restore following Plate ROAD-5001 for all work greater than thirty-six (36) inches from a joint or extend utility cut to the nearest joint for all work within thirty-six (36) inches from a joint.** In PCC pavement areas which show a medium severity condition of surface defects (this corresponds to roughly a PCI of approximately 74-60) or where upon visual inspections indicates significant faulting, random cracks, old utility cuts, asphalt patching, joint failures, the level of repair/removal shall extend to the original/existing pavement joint if the original pavement joint is within thirty six (36) inches to the proposed edge of the utility cut. If it is beyond this distance, then the proposed utility cut shall be the restoration limit. Perform all restoration work according to Minneapolis Standard Plate ROAD-5001, "Concrete Pavement Spot Cuts".

**Poor pavement condition (as determined by the City) restoration requirement:**

**Restore following Plate ROAD-5001 for all work greater than eighteen (18) inches from a joint or extend utility cut to the nearest joint for all work less than eighteen (18) inches from a joint.** In PCC pavement areas which exhibit a high level of severity and/or a higher variety of distresses than above (this corresponds to roughly a PCI of approximately 59-0) or as determined by visual inspection the restoration shall be to the original pavement joint if the joint is within eighteen (18) inches to the edge of the cut and then the removal shall extend to this original pavement joint. If it is beyond this distance, then the existing cut will remain the limit. Perform all restoration work according to Minneapolis Standard Plate ROAD-5001, "Concrete Pavement Spot Cuts".



For all restoration conditions, if manholes are encountered restore according to City of Minneapolis standard plates.

Panel replacement shall conform to the MNDOT State Aide Concrete Pavement Rehabilitation Best Practices Manual of 2006 or as modified by the City of Minneapolis Standard Plates whichever has the latest review date.

Concrete Pavement thickness shall be a minimum of eight (8) inches or match the existing pavement, thickness, whichever is thicker.

A minimum of four (4) inches of compacted MNDOT Class 5 aggregate base shall be placed directly below the concrete pavement.

All pavement sawing shall be full-depth cuts.

Class 5 aggregates shall meet the MNDOT and City of Minneapolis specifications requirements.

Concrete to be utilized for small pavement cuts shall be 3A41, 3F52 or 3HE52 and 3F52 or 3HE52 for curb and gutter construction. For large paving repair projects 3A41 or 3A41HE shall be used.

All bars are to be epoxy coated. Any cut bars shall be painted prior to installation.

All joints to be green cut after concrete placed. Cut time is determined by contractor .

All reestablished joints are to be hot pour sealed. All saw cut joints to be cleaned and air blasted before placement of approved hot poured sealant meeting MNDOT Specifications. The sealing of reestablished joints is considered to be a part of the panel restoration.

All affected pavement markings shall be replaced.

### **S-43 MATERIALS TESTING REQUIREMENTS**

The City of Minneapolis material testing requirements for all projects within the city right of way shall be performed at frequencies stated by the MnDOT Schedule of Materials Control, with the following amendments:

The link to the MnDOT Schedule of Materials Control is at the following:

<http://www.dot.state.mn.us/materials/labmcs.html>

Passing tests are required for all areas tested. Failing tests must be repeated after corrective action has been taken.

All the material testing reports shall be sent weekly to the Materials Engineer.

#### **Materials Engineer**

Chris DeDene  
 505 Fourth Ave. S Minneapolis, MN 55401  
 Phone: 612-673-2823  
 E-mail: [Chris.dedene@minneapolismn.gov](mailto:Chris.dedene@minneapolismn.gov)

At the end of the project, a full testing report file shall be delivered to the City of Minneapolis.

### **Soils and Aggregate Base**

#### **As far as Gradation:**

For imported material from known sources (that are not changing as the project proceeds) such as Select Granular Borrow/Aggregate Base Class 5, etc.: One gradation per material source per project is required.

#### **As for Densities:**

A standard “short” City of Minneapolis block is approximately 330’ centerline to centerline. The standard “long” City of Minneapolis block is approximately 660’. The testing requirements will be based on a block system. Hence, the testing location frequency is two locations per short block and four per long block.

Conduct a density test at a rate of one random location within every 330’ for each two feet of the backfill material (for example, an 8-foot-deep excavation should have 4 passing density tests at each test location). If used, correlate the nuclear density gauge with a sand cone density and moisture content at a rate of once per project.

For aggregate base, conduct a DCP test at a rate of one random location within every 165’.

The top of all base and subbase layers whose compacted area is greater than 12’ x 300’ shall be test rolled at the discretion of the Engineer.

#### **As for Proctors:**

Proctor testing is conducted to establish a maximum density for backfill materials for the density requirements above. One proctor per backfill material per project is required.

### **Concrete Pavement, Concrete Base and Curb and Gutter**

Slump, Air Contents and Cylinders will be performed with every concrete pour in excess of 5 CY on items that will ultimately become the property of the City of Minneapolis. Conduct these tests at a rate of one set per 100 CY of concrete per day per type of concrete.

#### **Asphalt**

One full asphalt test per 4,000 Ton per day is required to be performed (%AC, max. density, bulk specific gravity, gradation, FAA, CAA).

After the asphalt placement perform mat density cores per MNDOT specifications 2360.D. This is required in order to verify the compacted mat density.

**END OF DIVISION S - GENERAL SPECIAL PROVISIONS**

## DIVISION SL - LIGHTING SUPPLEMENTAL SPECIFICATIONS

### SL-1 (2545) ELECTRICAL SYSTEM

This work shall be done in accordance with the applicable Minnesota Department of Transportation “Standard Specifications for Construction”, 2016 Edition.

The provisions of MnDOT 2471, 2545, and 2565 shall apply in addition to the following: bidders are advised that compliance with the provisions of MnDOT 1702, MnDOT 2545.2A, and the first paragraph of MnDOT 2545.3A will be particularly enforced in conjunction with the construction of any kind or type of electrical system, conduit or conduit system for the conveyance of the electrical conductors, or the required portions thereof, as specified in the Contract. The Minnesota Electrical Act requires that a permit be obtained for the performance of all such work, including the installation of conduits.

#### SL-1.1 Scope of Work

The Contractor shall furnish all labor, equipment and materials for the installation and connection of separate underground distribution circuits in conduit to a street lighting system. These materials shall be as shown in the Plan or described within the special provisions and include but shall not be limited to the following items:

Electric Lighting System:

- street lighting poles and luminaires
- rigid steel and non-metallic conduits
- street light foundations (light bases)
- electrical handholes (pull boxes)– Minneapolis Standard
- street lighting pole wire
- in-the-line fuse holders and fuses
- service cabinets pad mounted, and service laterals
- service cabinet foundations
- end caps
- bus shelter feeds and circuitry
- lighting and bus shelter conductors

The electrical contractor is responsible for coordinating the turn on of all permanent electrical services with the City of Minneapolis Traffic and Parking Services Division

(TPS) and Xcel Energy. After State of Minnesota electrical inspection and approval of each metered electrical service location and after notification is provided to the TPS Electrical General Foreman (612-673-5759), the City will submit an application for electrical connection and meter installation to Xcel Energy.

## SL-1.2 GENERAL

The distribution circuits of the lighting system shall be of the multiple types consisting of four conductors installed in conduit. Three of the conductors shall constitute two 120-volt circuits and the fourth conductor shall be used as an equipment ground.

Power supply to the lighting system is metered 120/240 volt, single phase, alternating current, and shall be distributed from separate service cabinets regularly spaced throughout the project.

Reference to “the City” or “the City of Minneapolis” in these Special Provisions shall be interpreted to mean “the City of Minneapolis Traffic and Parking Services” or its designated representative.

The Contractor for this Contract shall be responsible for locating all Contractor-installed underground facilities within or outside the project limits until acceptance of the completed project by the City. City Traffic will provide written notice of system acceptance and transfer of ownership.

The City shall review and approve all work performed by the Contractor prior to the Contractor requesting acceptance by the Engineer.

Temp lighting shall be installed where street lighting is existing. Contractor shall contact Minneapolis Traffic 30 days prior to turning off any lighting.

**References to standard plates are subject to change. Contractor must verify the latest standard plate revision version on the City of Mpls website [http://www.ci.minneapolis.mn.us/publicworks/plates/public-works\\_traffic](http://www.ci.minneapolis.mn.us/publicworks/plates/public-works_traffic)**

## SL-1.3 Shop Drawings and Submittals

The Contractor shall submit to the Engineer for approval a complete list of electrical system components. This list shall include the names of all suppliers and manufacturers and catalog numbers for the various components. This list must be approved by the Engineer prior to initiating any work on the Electrical Systems.

The Contractor shall furnish to the Engineer, for preliminary review, an electronic pdf file of shop detail drawings that can be marked up and edited on Mpls Traffic software, in accordance with the provisions of MnDOT 2471.3B. The shop detail drawings shall be identified by "City of Minneapolis" and the fabricator. Drawings shall be returned to the Contractor showing any necessary corrections.

The Contractor shall furnish and obtain approval of templates used for setting anchor bolts and verifying concrete workmanship for all light and cabinet bases.

The Contractor shall furnish to the Engineer, for final approval, an electronic pdf file of the shop detail drawings that can be stored and edited on Mpls Traffic software systems. The name of the project shall be included in the file name title. The final approved shop detail drawing electronic pdf file shall be distributed, after approval to the following:

- (1) Contractor
- (2) Contractor's Fabricator
- (3) Project Engineer
- (4) City of Minneapolis Traffic and Parking Services

The shop drawing approval stamp is required by Minneapolis Traffic and Parking Services. Approval of shop drawings and submittals shall neither relieve the Contractor from the responsibility for deviations from the drawings or specifications unless he has, in writing, called the Engineer's attention to the deviations at the time of submission, and secured written approval, nor shall it relieve him from the responsibility for errors in shop drawings or submittals.

Provide certification by a Professional Engineer registered in the State of Minnesota that the lighting units have been designed to the loading requirements of the most current AASHTO Standard Specifications for Structural Supports for Highway Signs, Luminaries and Traffic Signals.

Submittals specifically for any proposed alternate lighting units not in conformance with the Minneapolis Streetlight Policy must be delivered to the Engineer no later than 4:00 p.m. sixteen (16) calendar days prior to bid opening. Only lighting units as shown in Contract drawings and Specifications will be accepted.

#### **SL-1.4 Materials**

The Engineer reserves the right to sample, test, inspect, and accept or reject any of the materials used for the Lighting Systems based on MnDOT or City of Minneapolis tests. However, the Engineer may, at his option, accept materials on the basis of listing by Underwriters Laboratories, Inc.

Fabrication and inspection of structural metals used for the Lighting Systems shall be in accordance with the applicable provisions of MnDOT 2471.

##### **A. Conduit**

1. NMC Conduit: NMC conduit and conduit fittings shall be either Type II heavy-wall rigid PVC Schedule 40 plastic conduit and conduit fittings

per MnDOT 3803. NMC MUST be UL Listed, Labeled, and Marked per the NEC. **A pull rope, Mule Tape 1800 or approved equal, shall be installed in each conduit along with each run for future use. Conduit not designated for immediate streetlighting use must have a tracer wire. Tracer wire shall be one (1) #10 AWG THHN, 600 volt single conductor cable (identifier conductor), orange in color. All tracer wires shall be terminated to the grounding electrode system. Pull rope shall be included with tracer wire.**

2. Metallic Conduit: Metal conduit shall be Rigid Steel Conduit (RSC) and conduit fittings per MnDOT 3801. Intermediate Metal Conduit (IMC) and conduit fittings are not permitted. RSC MUST be UL Listed, Labeled, and Marked per the NEC.
3. HDPE conduit shall be schedule 80 and MUST be UL Listed, Labeled, and Marked per the NEC.

**B. Handholes (Pull Boxes)**

All handholes shall be Minneapolis Electrical Handholes which have metal rings and covers as shown in Minneapolis Standard Plate Nos. TRAF-1710-R2 and TRAF-1715-R3 in the Plans and shall conform to the City of Minneapolis standards. Ring & Cover shall meet Tier 22 rating requirements (ANSI/SCTE 77-2007). A drain field shall be provided with each handhole. Concrete for supporting the metal ring and cover is required and shall be Mix No. 3A32 or equal.

Handholes rings and covers shall be constructed from Class 30 Grey Iron and left unpainted.

**C. Anchor Rods**

Anchor rods, nuts, and washers shall be galvanized in accordance with the provisions of MnDOT 3392 and the details shown in the Lighting Plan.

**D. Electrical Cables and Conductors**

All electrical cables and conductors shall conform to the requirements of MnDOT 2545.2D amended as follows.

The single conductor feeder wires, control wires, and distribution wires shall have Class B stranded annealed uncoated copper conductors and be listed by UL as Type RHW-2/USE-2, 90 degree C, crosslinked polyethylene, insulation rated 600 volts in accordance with Article 338 of the National Electrical Code. Cable shall meet requirements of ICEA Publication No. S-66-524, NEMA Pub. No. WC7 for crosslinked-polyethylene-insulated wire and cable, and UL standard 854 for service entrance cables. Wire shall bear UL label for Type USE-2, have footage markings every meter, and surface-marking indicating

manufacturer's ID, conductor size and metal, voltage rating, UL symbol and type designations. **The insulation on each conductor shall be colored red, black, white and green, in accordance with the color-coding shown in the construction plan. The wires shall be twisted in a planetary wrap with a consistent length of lay as per ICEA S-95-658.**

Single conductor pole wires connecting the luminaire to the distribution circuits shall be 1/C #12 stranded wire with THHN/THWN rating.

E. Service Cabinet

The service cabinet shall be the City of Minneapolis standard street light and signal service cabinet; shall be no bigger than that shown on the Plans; and shall be a pad-mounted, weatherproof control cabinet. See Equipment Pad details for specific service cabinet requirements at each service point.

1. Pad Mount Signal/Lighting Service Cabinet

The service cabinet shall be constructed in accordance with City of Minneapolis Standard Plate Nos. Traf-3500 and Traf-3631-R4 and the following:

- a. The cabinet enclosure (physical enclosure only) shall be UL listed with the UL label affixed to the inside of the cabinet, and shall carry a NEMA 3R rating to provide a degree of protection against rain, sleet, snow, and dripping water.
- b. Each cabinet shall be free of flaws, cracks, dents and other imperfections.
- c. All surfaces shall be smooth and clean.
- d. All seams and joints shall be smooth and even, without cracks, air leaks or pinholes with no sharp or jagged edges.
- e. All interior attachments to the cabinet exterior sheet metal shall be welded (i.e. no through bolts).
- f. There shall not be any sheet metal attached externally to the cabinet shell.
- g. Cabinet lifting provisions shall meet the UL requirements for the NEMA 3R cabinet. The lifting provisions shall consist of aluminum lifting ears mounted to extend above the top of the left and right sides of the cabinet enclosure, allowing a bar or hooks to be inserted through both ears for lifting the cabinet. The lifting ears shall have a lifting capacity equal to the weight of the



completely wired cabinet plus 25 percent, 500 pound capacity minimum. Each lifting ear shall have a 1 inch hole, the bottom of which shall be flush with the top of the cabinet or less than 3/8 inches above the top of the cabinet. The top of the lifting ear shall extend no more than 2 to 2 & 1/8th inches above the top of the cabinet at the point where the ear is attached. The lifting ears shall be centered on the cabinet side walls such that the cabinet will not pitch or tilt when lifted. The lifting ears shall be secured to the cabinet by means of stainless steel bolts, allowing the ears to be inverted. The positioning of items mounted inside the cabinet shall not restrict access to the bolts. Ship the cabinets with the lifting ears in the up position.

- h. The design, workmanship and attachment of the one-piece panel boards and dead fronts shall be a secure and aligned containment for the circuit breakers. The one-piece panel board and dead fronts shall be stamped with easily removable blank breaker cutouts to match the full capacity of the breaker panel. The panel board breaker cutouts shall precisely match the containment provisions of the breakers.
- i. The screws for attaching the cabinet dead fronts shall be of a permanent capture design to prevent lost and misplaced screws. Attachment of the dead fronts to the cabinet shall be accomplished using threaded inserts and offset cam cylinder latches.
- j. Contactors shall be normally open, NEMA rated, AC lighting contactors rated 277/480 volts with a 120-volt, 60 Hz coil, and contacts rated for 60 ampere tungsten filament load. Contactors shall be double lugged with the double lugs on the contactors installed such that field wires shall be connectable on the front lugs of the contactor. Contactors shall be installed vertically in the cabinet. Contactors shall have a positive gravity release. Contactors shall have an (off or on) condition display mechanism.
- k. The service cabinet shall have one 100 amp two-pole thermo-magnetic circuit breaker as a main breaker and single pole thermo-magnetic circuit breakers as branch breakers on each circuit panel.
- l. The Vendor shall furnish and install the following in each service cabinet:
  - Two (2) **200 amp meter sockets** with disconnect.
  - One (1) bracket mounted single pole test switch rated 15 amperes at 125 volts.
  - Two (2) 60 amp two pole contactors.

- 15 amp and 60 amp circuit breakers as indicated on details. All 60 amp multi-wire branch circuits shall have Schneider Electric / Square D QO1HT Handle Ties.
  - One (1) photoelectric cell.
  - Two (2) 12 circuit panels.
  - Power distribution terminal block.
  - Current limiting protector w/JJN-125 class T fuses
  - One (1) 120 volt 15/20 amp GFCI convenience receptacle.
- m. The photoelectric cell shall have normally open contacts rated 15 amperes. The photo control shall be installed within the lighting service cabinet. It shall be bracket mounted immediately behind a Plexiglas covered hole. The hole shall be located on the side of the cabinet. The hole size and location shall be as shown on the service cabinet detail. Mounting shall be as directed by the Engineer. The photoelectric control shall be in accordance with the MNDOT 3812 and have a minimum 30-second time delay capability.
- n. The electric meters shall be installed within the service cabinet as shown in the details. The electric meter sockets shall be suitable for single phase, 3 wire, 120/240 volt service with a utility approved manual bypass switch. The Utility Company will provide the electric meters. Sockets shall be provided and installed by the vendor. The placement of the meter socket and meter, door lock, and the viewing window shall permit the door to be closed, and the meter to be read electronically from outside the cabinet.
- o. Each cabinet shall have an anodized etched finish (Aluminum Association C22) with an Architectural Class 1 (Aluminum Association A42) hard coat finish of at least 0.7 mil. Finish color shall be 30 minute clear aluminum as directed by the City.
- p. Locks shall be furnished and installed by vendor. Locks shall be keyed for a standard No. 2 traffic signal key.
- q. No company logos and/or advertising shall be placed on any part of the cabinet exterior.
- r. The contractor shall be responsible for creating and installing arc flash warning labels. These labels shall meet the requirements of section 110.21(B) of the National Electric Code (NEC) and NFPA 70E Standard for Electric Safety in the Workplace. Contractor is responsible for obtaining all relevant information from Xcel Energy to perform the required calculations.

## F. Lighting Unit General Specifications

Poles and fixtures used for street lighting must be approved for use by the City of Minneapolis. Approval is based on operation, maintenance, and cost criteria. The following web site links provide information on the City of Minneapolis Street Lighting Policy. All 30-foot streetlight poles shall be:

- Material: high strength, low alloy steel 50,000 PSI min. yield (ASTM A571 or eq.), pole base plate material to be 36,000 psi min. yield (ASTM 36)
- Finish: UPS Brown paint over galvanized
- Final tube size: fabricate from 7E-8.00 X 3.57 X 31'-8:" & Cut to final length after bending.  
( 7 GA = 0.179" wall thickness)  
(E = rounded tapered steel tube @ 0.14 in/ft TAPER)  
Per standard plate TRAF-3206-R7  
30' pole transformer base per standard plate TRAF-3160
- Pole shall be manufactured in America.

<http://www.minneapolismn.gov/publicworks/streetlighting/index.htm>

Contact Minneapolis Traffic and Parking Services for current lighting unit specifications.

### Finishes

The luminaires, poles, arms, fitters, and all other exposed hardware shall be finished with polyester powder paint to insure maximum durability. All 15-foot streetlight poles shall have a black anodized finish. 15' poles manufactured per standard plate TRAF-3279-R2.

All painted metal parts shall go through an alkaline cleaning process, receive microcrystalline phosphate pretreatment, a sealing treatment, then the prepared metal surface shall be thoroughly rinsed with high purity deionized water to remove unwanted chemicals. A controlled drying process shall be completed prior to applying the electrostatic polyester powder paint. Color shall be per architectural specification.

### Warranty

All material for lighting units and banner poles shall come with a 5-year manufacturer's warranty. This warranty shall cover defects in material and workmanship for the paint finish, mechanical, optical, and electrical components. The manufacture shall either repair or replace any lighting unit or banner pole components due to these defects.

### Interchangeability of Parts

All major assembly items (pole, arm, fitter, luminaire) for lighting units shall be interchangeable with lights currently approved by the City.

G. Fuses

Street Light Standards in the 120/240-volt system shall be fused in accordance with Plan details. Fuses and fuse holders shall be “UL” listed. Fuse holders shall be Ferraz-Shawmut in-the-line FEB-11-11 with a FSB-1 waterproof boot or Cooper Bussmann, Inc. HEB-AW-RLC-A, and a Bussman BAF-10 single element fuse, or approved equal.

H. Light Base Design (Foundations)

Light pole bases and anchor rods shall be in accordance with City of Minneapolis Standard Plates. Contact Minneapolis Traffic and Parking Services for the current Standard Plate. All bases shall be level, flush and centered on the foundation cap.

I. Equipment Pad (M)

Anchor rods, nuts and washers in each lighting service cabinet concrete foundation shall be Type A Anchor Rods in accordance with MnDOT 3385; shall be galvanized full length in accordance with MNDOT 3392; and shall be four (4) sets in quantity for each cabinet (anchor rod, two hex head nuts, and washer). Each anchor rod shall be  $\frac{3}{4}$  inch diameter by 20 inches long before bending a 2-inch “L” on one end and the other end shall be threaded a minimum of 8 inches. Each anchor shall be provided with two (2) galvanized nuts and one galvanized washer. Service cabinet foundations shall be constructed in accordance with City of Minneapolis Standard Plate No’s. Traf-3094-R2 or Traf-3088 as shown on the Plans.

J. Availability of Material

Handhole (pull box) rings and covers, which meet the requirements of these Special Provisions may be able to be purchased depending upon availability from the Minneapolis Public Works Department, Traffic and Parking Services at the option of the Contractor. Contact Traffic Stores at (612) 673-5752.

## SL-1.5 Construction Requirements

A. Conduit Placement

Conduit size throughout the lighting project shall be 2-inch NMC unless otherwise noted on the Plans.

Conduits shall be installed underground a maximum of 12 inches from the back of the curb, except through bridges, approach slabs, and under railroad facilities, to a depth of 2 feet, as shown in the Plans or as directed by the Engineer. All conduits installed beneath surfaced streets shall be installed with a minimum cover of 2 feet. Cover material shall not contain rock or other debris that could damage the conduit. The cover material shall be firmly tamped into place in 6-inch lifts to minimize uneven settlement above or below the conduit.

The Contractor shall install red City of Minneapolis Traffic and Parking Services marking tape for marking underground Traffic utilities at a distance of 6 inches above all new conduit placed by the trenching method. Installation of the marking tape by the Contractor will be considered to be incidental work to installing the conduit and no direct payment will be made therefore. The required marking tape shall be purchased from the City of Minneapolis Traffic and Parking Services at 300 Border Avenue North.

B. Extension of Conduits:

The Contractor shall provide a continuous length of conduit of size and type noted on the Plans between the specified terminal points.

1. Installation of Conduit into handholes (pull boxes):

Conduits shall be installed entering handholes (pull boxes) through the sidewalls of the handholes (pull boxes), **not through the bottom gravel foundation**. Conduits shall be installed into handholes (pull boxes) by use of a hole saw to cut through the handhole (pull box) wall. Areas surrounding conduit entrances shall be sealed by filling them with mortar. Conduits installed by the Contractor shall extend a minimum of 1 inch and no more than 2 inches into any handhole (pullbox).

2. Installation of Conduits Under Driving Surface and Sidewalk:

All conduits that are to be placed under driveways, streets and sidewalk that are not scheduled for removal shall be directional bored, or other method approved by the Engineer that will not damage or disturb the integrity of the driveway, street or sidewalk. All conduits that are to be placed under driveways, alleys, streets, or sidewalk that are scheduled for removal must be placed during the time between the removal of the existing surface and the commencement of pavement operations. The Contractor is responsible for coordination with the paving operation.

3. Extension of Conduit into Handholes (pull boxes) at Traffic Signal Locations:

The signal assemblies with street light fixtures will have conduit stub outs. These stub outs shall be extended by the Contractor into handholes

(pull boxes) installed under the lighting construction Plans and specifications. The Contractor shall be responsible for verifying and coordinating the locations of these handholes (pull boxes) with signal construction prior to placing lighting conduits. Lighting and signals are not to share any conduit unless directly stated in the Plan or directed to do so by the Engineer in writing.

4. Connection to Existing Conduits:

The Contractor shall locate the ends of existing conduits as shown in the Plans and extend the conduit to handhole (pull box), luminaire pole base, etc. which is to be built by the Contractor. Existing conduits exterior surface shall be cleaned to form a secure connection to the extension.

5. Conduit Bends:

All conduit runs shall be straight and true, and all offsets and bends shall be uniform and symmetrical. **No more than 360 degrees of bends in any runs, no more than 180 degrees at any corner, and no 90 degree turns in handholes or fiber vaults. Underground conduits to follow plans as much as possible. Addition of any bends or offsets must be discussed with Traffic engineer or representative from City of Minneapolis and approved by the engineer.** All directionally bored conduit shall be bored directly from foundation to foundation. Foundations, handholes and vaults must be staked before commencing underground boring operations. **Field bends of conduit shall not be permitted unless performed with an approved heating / bending unit designed for that purpose.** The Contractor shall adjust the elevations of the conduit assembly, for its full length, to approximately the same gradient as the finished roadway, and shall furnish and install, in the trench, such suitable spacers and framing as may be necessary to maintain the correct grade and alignment.

C. Handholes (Pull Boxes)

Rings and covers shall be set in a bed of mortar and leveled to the finished surrounding grade. Cast-iron ring and covers constructed in accordance with City of Minneapolis Standard Plate No. TRAF-1715-R3 shall be furnished and installed by the Contractor. Handholes (pullboxes) shall be constructed in accordance with Minneapolis Standard Plate No. TRAF-1710-R1. A ring field shall be provided with each handhole (pullbox).

A drain field shall be provided with each handhole (pullbox). Rings and covers for new or relocated handholes shall be prepared for grounding prior to installation. Grounding shall be accomplished by attaching ground lugs for connecting both a 30 inch long #6 solid copper ground wire to the underside of the handhole ring and a 12 inch long #2 braided ground cable between the underside of the handhole ring and the underside of the handhole cover.

Handhole (pullbox) frame shall be connected with a ground clamp to a 1/2 inch by 8 ft ground rod sunk inside of the handhole.

Conduits shall be installed by the use of a hole saw to cut through the handhole (pullbox) wall. The area surrounding the conduit entrance shall be sealed with a mortar filling. Conduits shall extend a minimum of 2 inches and not more than 3 inches into the handhole (pullbox). No splicing is allowed in the handhole unless otherwise specified in these specifications.

The Contractor shall remove to the bottom of the handhole (pullbox), any excess material inside of the handhole (pullbox).

The Contractor shall salvage in place handholes (pullboxes) not reused as part of a revised permanent signal system unless otherwise directed by the Engineer. Metal handholes (pullboxes) shall not be reused.

High density polymer handholes shall be replaced with steel handhole ring and covers if disturbed or if adjacent concrete is removed or require relocation by the project. Reuse of these is not permitted.

#### C. Foundations (Light Bases)

All street light foundations (light bases) shall be constructed as shown on the Plan details and shall be located in the field by the Engineer. In general, the foundations (light bases) shall be placed with the centerline of the foundation (light base) **24 inches from the backside of the curb** at the appropriate elevation relative to the surrounding terrain. The Contractor is responsible for obtaining the location of existing utilities and for identifying any possible conflicts. Any such conflicts shall be reported immediately to the Engineer.

Concrete for all foundations (light bases) shall be Mix. No. 3Y43 free of chloride additives, placed and consolidated using vibratory equipment. All square foundations shall be **finished on all sides with broom finish and be edged with a 1/2" edger. All round foundations shall be chamfered with a 1/2" radius edger and broom finished on top**, all in accordance with the provisions of MnDOT 2565.3F. Concrete shall be allowed to cure for a minimum of seven (7) days before being placed into use unless otherwise permitted by the Engineer. All light pole bases shall have two 2" conduits for present and future street lighting connections. All 30ft foundations shall have an additional 2" stub for future or present small cell connection toward sidewalk.

Concrete bases shall be broom finished on all sides, level, and edged with a 1/2" edger. No more than 0.125 inches of variability compensated by shims will be allowed. Variability in excess of this will require resurfacing or replacement at the direction of the Engineer. Inspections will be performed using a Contractor supplied City approved 1/2" thick steel template manufactured to match the lights

bolt circle and foot print dimensions. **The first base shall be inspected in detail, approved and used as the standard for finish and workmanship. All foundations shall be installed utilizing approved templates. All templates required are incidental to the project.**

**All foundations shall be constructed such that the top of the foundation is at least 3 inches above the finished grade of the surrounding surface. All bases shall be level, flush and centered on the foundation cap.**

**Improperly constructed foundations shall be removed and replaced when directed to do so by the Engineer or corrected by the City Forces at the expense of the contractor.**

**Provide an additional conduit sweep with cap or plug when the base is for the last light on a circuit.**

D. Installation of Lighting Units

The Contractor shall mount light standards directly on the foundation (light base). The use of leveling nuts is not permitted. Any light standards that are not plumb shall be corrected up to 0.25 inches using stainless steel washers. **The Contractor, at the Contractor's expense, shall recap or replace foundations (light bases) that are incorrectly installed.**

Davit mounted luminaires shall be installed with the LED board level in all directions. Post top mounted luminaires shall be installed with correct orientation of the designated street side and house side defined by the manufacturer.

E. Wiring of Luminaires

The four conductor lighting distribution circuits shall pass through the transformer base of each street light luminaire pole, and traffic signal light pole as shown on Plans. The lighting circuits share a common ground. The conductors shall be fused with the fuses installed in the phase wire to the luminaire-mounted ballast at the base of the light standards as directed by the Plans, specifications herein, and the Engineer. Fuse holders shall be installed in such a manner that the fuse stays with the load side when the holder is separated. Suitable solderless connectors shall be used. **All splices must take place in pole bases unless approved by the Engineer.** All splices shall be weather tight and use Burndy Multi-Tap BIBS-4-3 or 4-4 connectors as noted in City of Minneapolis Standard Plate Nos. Traf-3623-R1 and Traf-3627-R2. For payment purposes the splicing connector, fuse holder, fuse, and the luminaire connection cabling shall be considered to be incidental to the luminaire.

Sufficient excess conductor length shall be provided for maintenance purposes. In addition, the Contractor shall form loops in the leads on each side of the fuse



holders and so position the fuse holders so that they may be easily removed or inserted through the access hole. The grounding conductor shall not be fused.

The 120 VAC conductor to the luminaires shall be alternately connected to the red or the black conductor of the street lighting distribution circuit. No two loads shall be wired on the same phase consecutively.

The Contractor shall submit a sample of the fuse holder and splice connectors they will be installing BEFORE any installations are made.

F. Grounding

The grounding conductor shall be bonded to the grounding lug and the foundation (light base) ground rod at every third street light. A No. 12 AWG bare copper conductor shall be used.

G. Painting

All lighting units shall be factory painted by the manufacturer as described in the lighting unit section.

Painting of all other equipment shall be in accordance with the provisions of MnDOT 2565.3, except that finish coat paint for all items shall be two coats.

Paint samples must be submitted to the Engineer for approval prior to painting. The Contractor shall furnish all paint required after confirmation of the exact paints and colors.

All lighting units shall be shop or factory painted as required except for providing any necessary repairs of damage to paint coats that occur during unloading and erection at the site.

H. Wiring of Service Cabinets

Where service equipment is supplied from the Utility Company's overhead circuits, lightning surge arrestors shall be installed in the cabinets on the supply side of the service equipment.

At the pad mounted service cabinets, the Contractor shall establish a 25-ohm ground by the use of copper clad ground rods.

A No. 6 AWG bare copper wire shall be extended from the ground rods and be bonded to the pad mounted service cabinet. The ground rods shall be cast into the service cabinet pad and be inside the service cabinet ring.

When called for in the Plans, two (2) No. 2 AWG lighting conductors and one No. 2 AWG neutral conductor shall be extended underground from the pad

mounted service cabinet in 2 inch RSC conduit to the utility company service vault or transformer. These #2 conductors shall be color coded red, black, and white. They shall be USE or better insulated.

When called for in the Plans, two (2) No. 2 AWG lighting conductors and one No. 2 AWG neutral conductor shall be extended underground, in conduit, from the pad mounted service cabinet to the utility companies pole and up the pole in 2 inch rigid galvanized steel conduit to a weather head located below the utility distribution circuits as directed by the utility and as shown on City of Minneapolis Standard Plate No. Traf-3510 and in the Plans.

The ground conductor shall be terminated in and be bonded to the pad mounted control cabinet. The neutral conductor shall be bonded to the ground conductor in the pad mounted control cabinet.

Feeder conductors shall be color-coded in the control cabinet and at the weather head or service vault.

The utility will make the final service connections after the Contractor has filed a Certificate-Affidavit of Inspection, with the utility.

#### I. Cabinet Pads

Concrete pad finishing shall be broom finished on all sides, level, and edged with a ½ inch edger. No more than 0.125 inches of variability compensated by shims will be allowed. Variability in excess of this will require resurfacing or replacement at the direction of the Engineer. Inspections will be performed using a Contractor supplied City approved ½” thick steel template manufactured to match cabinet dimensions. The first pad shall be inspected in detail, approved and used as the standard for finish and workmanship. All templates required are incidental to the project.

#### J. Removing and Salvaging Existing Systems

When directed by the Engineer, the Contractor shall remove and salvage all items of the existing street lighting systems, underground cable, conduit, service equipment, cabinet and street light foundations (light bases), and handholes (pull boxes), in accordance with the applicable provisions of MnDOT 2104; with the applicable provisions of MnDOT 2565.3T, and the following:

1. Underground conduit shall be removed unless otherwise directed by the Engineer.
2. Salvaged items shall be disassembled as directed by the Engineer and shall be delivered to the City of Minneapolis Traffic and Parking Services Division at 300 Border Avenue North, Minneapolis.

The Contractor shall contact the City Traffic and Parking Services office at least three working days in advance of delivery as follows:

Traffic Electrical General foreman Telephone: 612-673-5759

**Before** returning salvaged items to City of Minneapolis, contractor to meet on site with Traffic Electrical General foreman (612-673-5759) to determine what to salvage or scrap.

Any damage to the salvaged materials resulting from the salvage operation shall be repaired and replaced at the Contractor's expense.

3. Salvaged items shall be disassembled before being delivered to the City of Minneapolis as follows:
  - Salvaged Luminaires shall be removed from the luminaire mast arms before being delivered to the City of Minneapolis.
  - Banners and brackets shall be removed.
  - Fixtures shall be removed from street light poles.
  - Attachments such as cameras, wifi, and cellular equipment shall be coordinated with utility owners.
  - All other salvable items shall be removed and disassembled as directed by the Engineer.
4. Concrete pole foundations (light bases), conduit, and other items, deemed nonsalvagable by the Engineer, of the existing street lighting systems shall be removed and disposed of outside the right of way in any manner that the Contractor may elect subject to the provisions of MnDOT 2104.3C3 and as noted elsewhere in these Special Provisions.
5. Removal of Existing Underground Facilities
 

All existing underground street light facilities will be removed under the site work activities. The Contractor shall perform removal of existing conduit, handholes, (pull boxes), cabinet foundations and pole foundations (light bases) during pavement and sidewalk removal. Removal of existing cable between lighting units shown on the Plans shall be performed by the Contractor prior to pavement and sidewalk removal. The removal of cable and handholes (pull boxes) shall be considered incidental to the lighting unit and conduit removal activity and no direct compensation shall be paid for this work.
6. The concrete pole foundations (signal and light bases) and the underground signal and lighting conduits include asbestos containing electrical conduits (Transite). The 3' x 18" vertical pipe in handholes may also contain asbestos (Transite). Underground signal and lighting conduits that contains asbestos will have been encased in concrete at the

time of installation. For the procedure for handling and disposal of these asbestos-containing materials see the Asbestos Abatement located in Appendix A in Division SS.

7. The removal and salvage of in-place lighting units shall be measured on an each basis.
8. The provisions on MnDOT 1903 are modified such that no price adjustment will be made in the event of increased or decreased quantities for removing and salvaging existing systems.

K. As-Built Drawings

See the “Record Drawing Requirements” section of Division S for more information.

L. Final Lighting Systems Inspection

The Contractor shall not receive full payment for the installation of the lighting systems nor will the City take over maintenance responsibility for the lighting system until the City of Minneapolis performs a punch list inspection of the installed facilities and all noted discrepancies are corrected by the Contractor to the satisfaction of the City.

**END OF DIVISION SL - LIGHTING SPECIAL PROVISIONS**

## DIVISION SS - SIGNALS SUPPLEMENTAL SPECIFICATIONS

### SS-1 (2565) TRAFFIC CONTROL SIGNALS

- A. This work shall consist of furnishing and installing all materials and electrical equipment to provide a new pre-timed, or semi traffic actuated, traffic control signal system at the following locations:

System A –  
 System B –  
 System C –  
 System D –  
 System E –  
 System F –  
 System G –

- B. This work shall consist of removal and salvage of all or portions of in place traffic signal control systems from the following locations:

System A –  
 System B –  
 System C –  
 System D –  
 System F –  
 System G –

**Removal and disposal of conduit and handholes with asbestos containing conduits (Transite) shall be paid in accordance with the “Method of Payment” included in these Specifications. The removal process is explained in Appendix A. The City of Mpls Traffic Department must receive copies of all transite waste haul manifests related to the project.**

- C. This Contract also includes work which consists of furnishing and installing an interconnect system between traffic control systems:

Interconnection of Systems “A-G” to each other, and removing and reinstalling interconnect to others signal systems as shown on the plans.

- D. The following work to be completed by the “City of Minneapolis” shall consist of furnishing and installing, and removing and salvaging all materials and electrical equipment to provide temporary traffic signal control systems and modifications to systems “A”, “B”, “C”, “D”, “E”, “F” and “G”.

The Contractor shall notify the “City of Minneapolis” at least thirty (30) working days before the above work needs to be completed. The Contractor shall also notify the

“City of Minneapolis” at least five (5) working days before any modifications to the temporary traffic signals are needed.

This work shall be done in accordance with the applicable Minnesota Department of Transportation “Standard Specifications for Construction,” 2018 Edition.

### SS-1.1

#### General

- A. All applicable provisions of the current edition of the National Electrical Code shall apply in constructing the traffic control signal systems.
- B. Reference to “the City” or “the City of Minneapolis” in these Special Provisions shall be interpreted to mean “the City of Minneapolis Traffic and Parking Services” or its designated representative.
- C. City forces shall make all field lead connections in the City of Minneapolis furnished traffic signal cabinet at each System. The Contractor for this Contract shall label all cables and conductors in accordance with the field-wiring diagram at each System.
- D. The City shall approve all foundation and loop detector locations before construction is commenced.
- E. Construction operations in the proximity of utility properties must be performed in accordance with the provisions of MnDOT 1507, except the first paragraph is hereby deleted and the following substituted therefore:
 

It is the Contractor's own responsibility, prior to commencing work, to secure information and determine the exact location of any buried utility facilities as may exist, and to conduct operations in the vicinity of any such facilities in a manner that precludes damage thereto. The Contractor agrees to be fully responsible for any and all damages that might be occasioned by failure to exactly locate and preserve any and all underground utilities.
- F. Coordinate all signal related construction work with the construction of the pedestrian curb ramps and sidewalks. Schedule placement of conduit, handholes, foundations, etc. to be coordinated with operations involving the construction of the area pedestrian curb ramps and sidewalks.
- G. The Contractor for this contract shall be responsible for locating all Contractor installed underground facilities within or outside the project limits until acceptance of the completed project by the City. City Traffic Department will provide written notice of system acceptance and transfer of ownership.
- H. The City shall review and approve all work performed by the Contractor prior to the Contractor requesting acceptance by the Engineer.
- I. The Contractor's attention is specifically directed to the requirements of 2565.2A5 regarding the required in service warranty period for workmanship and materials.

- J. At locations where temporary traffic control signal systems are specified:

Ensure that each existing traffic control signal system or a combination of existing and temporary equipment are kept in operation at all times, unless otherwise approved by the City for an existing traffic control signal system to be turned off to facilitate construction.

At locations where temporary traffic control signals system are not specified and existing signal systems will be off during construction:

The duration that an existing traffic control signal system is turned off must be approved by the City and shall not exceed six consecutive weeks unless otherwise authorized by the Engineer. A periodic project progress meeting will be scheduled with the City. Signalized intersections that are not temped shall be placed on all way stop.

Contractor shall not turn off an existing control signal system without the specific approval of, and only in the presence of, the Engineer. Notify the Engineer at least one week in advance of scheduled turn-offs and before performing work on the existing traffic control signal system.

Signalized intersections shall have temp lighting to meet existing light levels. Temp lighting shall be installed where street lighting is existing. Contractor shall contact Minneapolis Traffic 30 days prior to turning off any lighting.

- K. Provide to the Engineer and the City an electronic pdf file of manufacturer drawings capable of being stored on Mpls Traffic software for all items to be used from the MnDOT Approved/Qualified Products List and as contained in these specifications. Submit the manufacturer's drawings and any required warranty information at the project's Preconstruction meeting or as requested by the Engineer. Electronic drawings may also be submitted. All manufacturers' drawings must be approved by the City and by the Engineer prior to procurement by the Contractor.

Submit products showing compliance with contract documents. Review shop drawings for accuracy, completeness, and compliance with contract documents prior to submittal.

The Engineer's review and approval of shop drawing submittals does not relieve the responsibility for providing products that comply with the contract documents.

- L. The Contractor must maintain pedestrian access on all corners of each intersection at all times unless specifically approved by the Engineer and the

City. See Division S (S-4) of these specifications for detail regarding the maintenance of traffic.

- M. The standard plate revision numbers in this document are subject to change, check the city's website for current revision numbers. [http://www.ci.minneapolis.mn.us/publicworks/plates/public-works\\_traffic](http://www.ci.minneapolis.mn.us/publicworks/plates/public-works_traffic)
- N. For signal, lighting, or interconnect questions during construction contact the signal engineer Bill Prince at 612-673-3901.

## SS-1.2

### Materials

#### A. Metal Conduit

Metal conduit shall be Rigid Steel Conduit (R.S.C.) and conduit fittings per MnDOT 3801 Intermediate Metal Conduit (I.M.C.) and conduit fittings are not permitted.

#### B. Non-Metallic Conduit

Non-metallic conduit (N.M.C.) and conduit fittings shall be Type II heavy-wall rigid PVC Schedule 40 plastic conduit and conduit fittings per MnDOT 3803. **A pull rope, Mule Tape 1800 or approved equal, shall be installed in each conduit along with each run for future use.**

HDPE conduit shall be schedule 80 and MUST be UL Listed, Labeled, and Marked per the NEC.

#### C. Handholes

All handholes shall be Minneapolis Electrical Handholes which have metal rings and covers as shown in Minneapolis Standard Plate Nos. TRAF-1710 and TRAF-1715-R3 in the Plans and shall conform to the City of Minneapolis standards. Ring & Cover shall meet Tier 22 rating requirements (ANSI/SCTE 77-2007). A drain field shall be provided with each handhole. Concrete for supporting the metal ring and cover is required and shall be Mix No. 3A32 or equal.

Handholes rings and covers shall be constructed from Class 30 Grey Iron and left unpainted.

Existing handhole rings and covers that are to be relocated shall be cleaned and left unpainted. Do not reuse polymer concrete handholes and rings, they must be replaced by steel ones.

#### D. Anchor Rods

The Contractor shall furnish all required anchor rods, nuts, and washers in traffic signal pedestal concrete foundations and in mast arm pole foundations.



1. Minneapolis Mast Arm Foundation: Anchor rods, nuts, and washers in each mast arm pole standard concrete foundation shall conform to the City of Minneapolis standards; shall be galvanized the entire length of each anchor rod in accordance with the provisions of MnDOT 3392; and shall be four (4) sets in quantity (anchor rod, two nuts, and two washers) of the dimensions and configuration in accordance with the “Minneapolis Overhead Signal Foundation” (Minneapolis Standard Plate Nos. Traf-1120 and Traf-1130) in the Plans. All anchor rods required in each mast arm pole standard concrete foundation shall be either size 1.75 inches diameter by 71 inches long or 1.5 inches diameter by 68 inches long, as specified. See Minneapolis Standard Plate Nos. Traf-1072-R4 and Traf-1074-R4 in Plans.
2. Traffic Signal Pedestals: Anchor rods, nuts, and washers in each traffic signal pedestal concrete foundation shall conform to the City of Minneapolis standards; shall be galvanized at least the top 28 inches of each anchor rod in accordance with the provisions of MnDOT 3392; and shall be three (3) sets in quantity (anchor rod, nut, and washer) of the dimensions and configurations in accordance with the “Minneapolis Signal Base Anchor Rod” detail in the Plans. All anchor rods required in each traffic signal pedestal concrete foundation shall be size 5/8 inches diameter by 40 inches long before bending. See Minneapolis Plate No. Traf-1140-R1.
3. Rust Inhibitor: Threaded portions of all anchor rods above the concrete foundations shall be coated with an approved rust inhibitor before installation of the mast arm pole standards, and traffic signal pedestals on the anchor rods.

E. Traffic Signal Electrical Cables And Conductors

1. The provisions for electric cables and conductors of MnDOT 2565.3J and MnDOT 3815 are modified as follows. The required electrical cables to Xcel’s feed points shall be furnished and installed by the Contractor and shall be the size as required by the power company.
2. Detector Lead-in Cable: Detector lead-in cable shall meet the requirements of the International Municipal Signal Association (IMSA) Specifications 50-2, latest revision thereof for polyethylene insulated, polyethylene jacketed loop detector lead-in cable. All conductors shall be #14 A.W.G. unless otherwise specified on the Plans.
3. Signal Control Cable: The multiple conductor control cables for traffic control signals shall meet the following specification. This specification describes multi-conductor Type TC Tray Cable insulated with FR-XLP flame-retardant cross-linked polyethylene and PVC jacketed overall, for use on circuits rated 600 volts at 90 degrees C maximum continuous conductor temperature in wet or dry locations. The cables shall be

approved for installation in cable trays in accordance with Article 340 of the NEC and also for use in Class 1 remote control and signaling circuits per Article 725-11(b) of the Code. Cable shall be approved for installation in open air, in ducts or conduits, in tray or trough, and be suitable for direct burial.

#### Applicable Standards

a. The following standards shall form a part of this specification to the extent specified herein:

- Underwriters Laboratories Standard 1277 for Type TC Power and Control Tray Cables.
- Underwriters Laboratories Standard 44 for Rubber Insulated Wires and Cables.
- ICEA Pub. No. S-66-524, NEMA Pub. No. WC7, Cross-linked-polyethylene-insulated Wire and Cable.
- ICEA Pub. No. S-73-532, NEMA Pub. No. WC57, Control Cables
- IEEE Standard 1202 - Flame Testing of Cables for Use in Cable Tray in Industrial and Commercial Occupancies.

b. Conductors

Conductors shall be Class B stranded uncoated soft copper conforming to Part 2 of ICEA. Conductor sizes shall be 14 AWG. A non-hygroscopic separator may be used over the conductors at the option of the manufacturer.

c. Insulation Compound:

Each conductor shall be insulated with FR-XLP flame-retardant chemically cross-linked polyethylene, meeting the requirements of ICEA S-66-524, Par. 3.6, ICEA S-73-532, Table 3-2 (Type I-XLPE) and Type XHHW-2, VW-1 requirements of Underwriter's Laboratories.

- Thickness: The average thickness of insulation shall be 30 mils. The minimum thickness at any point shall be not less than 90 percent of the specified average thickness.

d. Circuit Identification

Circuit identification shall consist of Method 1 color coding for National Electrical Code applications in accordance with ICEA S-73-532, Appendix E, Table E-2. Cables shall contain the

following color coding for individual conductors: 1-Black, 2-White, 3-Green, 4-Red, 5-Blue, 6-Orange, 7-Yellow, 8-Red w/Black tracer, 9-Blue w/Black tracer, 10-Orange w/Black tracer, 11-Yellow w/Black tracer, 12-Black w/White tracer. **Tracers shall be spiral bands on opposite sides of each conductor.**

e. Assembly

The insulated color-coded conductors shall be cabled together with non-hygroscopic fillers, when necessary to make round. Fillers shall not be jute or paper. The cable assembly shall be covered with a suitable tape applied with a 10 percent minimum lap.

f. Overall Jacket

- Compound: Each cable shall have a PVC protective jacket applied over the assembly. The jacket shall meet the requirements of Part 4 of ICEA S-73-532, Table 4-2, and the Sunlight Resistant requirements of UL Standard 1277.
- Thickness: The average jacket thickness shall be in accordance with UL Standard 1277. The minimum thickness at any point shall be not less than 80 percent of the specified average thickness.

g. Surface Marking

Cables shall be clearly identified by means of surface ink printing indicating: Manufacturer, Type TC, (UL), 600V, 12 conductors, #14, XHHW-2 (or 90 degrees C) Conductors, Sunlight Resistant, Direct Burial, E57349, and have length markings approximately every meter.

h. Tests

- Individual conductors and completed cables shall be tested in accordance with UL requirements for Type TC Power and Control Tray Cables having XHHW-2 VW-1 insulated conductors.
- Cables shall be capable of passing the ribbon burner cable tray flame test requirements of UL and IEEE Standard 1202.

4. Signal Head Wire: All circuit wiring from the signal base or transformer base to the traffic signal vehicle and pedestrian indications in pedestal and mastarm poles shall be 1/C#14 AWG solid copper wires with XHHW rating. The conductors shall have insulation color coded in

accordance with Minneapolis Plate No's. Traf-1560-R1, Traf-1566-R1, Traf-1578 and Traf-1584.

5. Mast Arm Head Cable: All circuit wiring from the transformer base to the traffic signal vehicle indications mounted on the mastarm of a mastarm pole shall be a Type-TC □□ degree 600 volt cable composed of 7-□/C#14 AWG THHN/THWN stranded copper wires in a sunlight resistant direct burial jacket. The conductors shall have insulation color coded in accordance with Minneapolis Standard Plate Nos. Traf-1560-R1 and Traf-1566-R1 (ICEA Method 1, Table E-1).
6. Loop Wire: Wire used for inductive loops shall be single conductor No. 14 AWG standard copper insulated with filled chemically cross-linked polyethylene (XLP) and be constructed in accordance with IMSA Specification 511 with a polyvinyl chloride tube.

Roadway loop detector conductors shall be one of the following or City of Minneapolis approved equal.

- Model DSI-116S Loop Detector Wire as manufactured by Detector Systems, Inc., 11650 Seaboard Circle, Stanton, California 90680;
- Model 1419-XLP-TUBE as manufactured by Kris-Tech Wire Co., Inc. 921 Seneca Street, P.O. Box 4377, Rome, New York 13440-4377;
- Model 320095 Power Loop as manufactured by Tamaqua Cable Products Corporation, P.O. Box 347, Schuylkill Haven, Pennsylvania 17972.

The roadway loop detector conductors shall be approved by the Engineer before procurement.

7. Single Conductor Wires: The single conductor feeder wires, and control wires shall have Class B stranded annealed uncoated copper conductors and be listed by UL as Type RHW-2/USE-2, 90 degree C, crosslinked polyethylene insulation rated 600 volts in accordance with Article 338 of the National Electrical Code. Cable shall meet the requirements of ICEA Publication No. S-66-524, NEMA Pub. No. WC7 for Crosslinked Polyethylene-Insulated Wire and Cable, and UL Standard 854 for Service Entrance Cables. Wires shall bear UL label for Type USE-2, have footage markings approximately every meter, and surface marking indicating manufacturer's ID, conductor size and metal, voltage rating, UL symbol and type designations. **The insulation on each conductor shall be colored red, black, green, or white in accordance with the color-coding shown in the construction plan and/or standard plates. The wires shall be twisted in a planetary wrap with a consistent length of lay as per ICEA S-95-658.**

8. EVP Confirmation Light Cable: Wire used for powering EVP confirmation lights shall be 2/c #14 W/GRD conforming to the requirements of International Municipal Signal Association, Inc., Specification No. 50-2 1984, Polyethylene Insulated, Polyethylene Jacketed Loop Detector Lead-In Cable.

9. Optical Detector Cable:

Optical detector cable shall be in accordance with the provisions of MnDOT 3815.2C5.

F. Mast Arm Pole Standards

The provisions of MnDOT 3831 are modified as follows for Minneapolis Style Equipment:

Each mast arm pole standard shall consist of a transformer base, a vertical pole shaft, a traffic signal upper cantilever mast arm, provisions for a lower mast arm for sign support, and (if specified in the Plans) a luminaire vertical pole shaft extension with davit-type mast arm and a lower sign arm.

Each mast arm pole standard shall be designed and constructed in accordance with the requirements of the 1994 edition of the “Standard Specifications for Structural Support for Highway Signs, Luminaires and Traffic Signals” as published by the American Association of State Highway and Transportation Officials.”

The transformer base shall be stainless steel, constructed in accordance with details shown in the Plans, and be a square transformer base style complete with access hole and door. The access hole shall provide an opening of at least 100 square inches on one side of the base and shall be provided with a door having positive closure. The locking mechanism shall be an integral part of the door.

The extended end of each traffic signal mast arm shall have a 2-3/8 inch outside diameter slipfitter and signal mounting plate welded to the end in accordance with the details in MnDOT Standard Plate No. 8123E for attaching one-way or two-way mast arm signal head mounts.

Attachment of the traffic signal upper and/or lower cantilever mast arm to the vertical pole shaft shall be by high strength bolts and nuts.

Each mast arm pole standard shall be the City of Minneapolis design, as shown in the detail section of the Plans.

Each individual mast arm pole standard shall be constructed to the traffic signal mast arm length, luminaire mast arm length, and luminaire mounting height as specified in the Plans.

When sign arms are required, the sign arm and mast arm shall be vertically aligned and horizontally parallel to the ground.

The Contractor shall furnish to the Engineer, for approval, electronic pdf file of shop detail drawings of each type of mast arm pole standard in accordance with the provisions of MnDOT 2471.3B. The shop detail drawings shall indicate all member materials and dimensions, section modulus of all main component parts, and other pertinent data and calculations. The shop detail drawings shall be identified by “City of Minneapolis” and the fabricator. The City of Minneapolis Traffic and Parking Services shall approve shop drawings.

A shop coat of primer and finish paint shall be applied to the outside surfaces of each mast arm pole standard, mast arm, luminaire extension and transformer base.

G. Traffic Signal Pedestals

The provisions of MnDOT 3832 are modified as follows:

Each traffic signal pedestal shall consist of a pedestal base with access door opening; pedestal shaft; three tie rods; and a pedestal slipfitter collar with signal bracketing and pipe fittings in accordance with City of Minneapolis standards. Each pedestal slip fitter collar shall have four (4) 1.5 inches diameter threaded side openings spaced 90 degrees apart with unused openings plugged with gasketed, threaded caps.

The overall length of each installed traffic signal pedestal shall be 10 feet.

H. For assembly information for the City of Minneapolis traffic signal pedestal, see Minneapolis Plate No. Traf-1266-R1 in the Plans.

I. Pedestrian Push Button Stations, Pedestrian Push Buttons, and Pedestrian Instruction Signs

Each new pedestrian push button station shall consist of a concrete foundation, a 4-inch diameter standard spun aluminum pipe with aluminum dome pipe cap, and a standard APS push button pole base, all conforming to the City of Minneapolis standards. See Minneapolis Standard Plate No. Traf-1260-R5.

All pedestrian push buttons required by the Plans shall be in accordance with the provisions of MnDOT 3833 and the following:

1. The Contractor shall furnish to the Engineer, for approval, electronic pdf file of shop drawings and specifications. The proposed push button assemblies shall be ADA-compliant and subject to approval by the City of Minneapolis Traffic and Parking Services. The pdf shall be distributed by the Engineer as follows:
2. City of Minneapolis Traffic Division A pedestrian instruction sign shall be furnished to the Contractor by the City for installation with each pedestrian push button installation in accordance with the provisions of MnDOT 3833.

## I. Accessible Pedestrian Push Buttons and Signs

Pedestrian push button installation shall be in conformance with the MnDOT Standard Specifications for Construction 3833 modified as follows:

1. Pedestrian push buttons shall be installed on mast arm pole shafts, pedestal shafts, light pole shafts or be a separate mounting in conformance with MnDOT APS Push Button Mounting Detail or ADA Pedestrian Station Detail. These Details can be found on the Office of Traffic, Safety, and Operations (OTSO) WEB site for Traffic Signals:

<http://www.dot.state.mn.us/trafficeng/signals/index.html>

2. Each push button shall be located by the Engineer in the field to allow easy access for the pedestrian.
3. The Contractor shall supply the APS system in full, including push buttons, control boards, central control units, configurators, and any other equipment needed to provide the APS system. All APS shall include bluetooth and touchless functionality. Approved APS systems are listed on the MnDOT Approved/Qualified Products Lists WEB site for Signals:

<http://www.dot.state.mn.us/products/index.html>

APS extender pipes are required as part of the system to properly align buttons parallel to crosswalks where APS is mounted to mast arm poles. The pipe shall be painted to match the pole color.

**The Contractor shall insure the order form below is presented to the Accessible Pedestrian Signal (APS) manufacturer so the appropriated Braille message will be added to the pedestrian information sign and the correct voice messages will be programmed in the pedestrian push button stations.**

The Contractor shall provide digital files containing the custom voice messages to Minneapolis Traffic staff.

**Accessible Pedestrian System (APS)**

**ORDER FORM**

(Fill out one form per intersection)

**Intersection:**

**Total Qty of Pedestrian Push Buttons:** \_\_\_\_\_

**Control Board:** One needed for each intersection **Qty**\_\_\_\_\_

**CCU:** (Central Control Unit) One needed for each intersection **Qty**\_\_\_\_\_

**CONFIG:** (Configurator) One needed for each intersection **Qty**\_\_\_\_\_

**Push Button and Sign Braille Information**

Button	Arrow Direction R/L	Street Name (Street Being Crossed)
PB2-1		
PB2-2		
PB4-1		
PB4-2		
PB6-1		
PB6-2		
PB8-1		
PB8-2		

**Custom Voice Message Details**

Voice on Location and Walk Message(s) Please give phonetic pronunciation on difficult street names so that the message will be recorded correctly.

\*Note that unless Street, Drive, Avenue etc...are absolutely necessary for intersection identification, it is recommended to not include them in the verbal message.



**PB2-1**

Wait Message:		
<b>Wait to Cross</b>	<input type="text"/> (Street Being Crossed)	at <input type="text"/> (Intersecting Street)
Walk Message:	<input type="text"/> (Street Being Crossed)	<b>Walk sign is on to cross</b> <input type="text"/> (Street Being Crossed)

**PB2-2**

Wait Message:		
<b>Wait to Cross</b>	<input type="text"/> (Street Being Crossed)	at <input type="text"/> (Intersecting Street)
Walk Message:	<input type="text"/> (Street Being Crossed)	<b>Walk sign is on to cross</b> <input type="text"/> (Street Being Crossed)

**PB4-1**

Wait Message:		
<b>Wait to Cross</b>	<input type="text"/> (Street Being Crossed)	at <input type="text"/> (Intersecting Street)
Walk Message:	<input type="text"/> (Street Being Crossed)	<b>Walk sign is on to cross</b> <input type="text"/> (Street Being Crossed)

**PB4-2**

Wait Message:		
<b>Wait to Cross</b>	<input type="text"/> (Street Being Crossed)	at <input type="text"/> (Intersecting Street)
Walk Message:	<input type="text"/> (Street Being Crossed)	<b>Walk sign is on to cross</b> <input type="text"/> (Street Being Crossed)

**PB6-1**

Wait Message:	
---------------	--

Walk Message:	<input type="text"/>	at	<input type="text"/>
	(Street Being Crossed)		
	<input type="text"/>	<b>Walk sign is on to cross</b>	<input type="text"/>
	(Street Being Crossed)		(Street Being Crossed)

**PB6-2**

Wait Message:			
<b>Wait to Cross</b>	<input type="text"/>	at	<input type="text"/>
	(Street Being Crossed)		(Intersecting Street)
Walk Message:			
	<input type="text"/>	<b>Walk sign is on to cross</b>	<input type="text"/>
	(Street Being Crossed)		(Street Being Crossed)

**PB8-1**

Wait Message:			
<b>Wait to Cross</b>	<input type="text"/>	at	<input type="text"/>
	(Street Being Crossed)		(Intersecting Street)
Walk Message:			
	<input type="text"/>	<b>Walk sign is on to cross</b>	<input type="text"/>
	(Street Being Crossed)		(Street Being Crossed)

**PB8-2**

Wait Message:			
<b>Wait to Cross</b>	<input type="text"/>	at	<input type="text"/>
	(Street Being Crossed)		(Intersecting Street)
Walk Message:			
	<input type="text"/>	<b>Walk sign is on to cross</b>	<input type="text"/>
	(Street Being Crossed)		(Street Being Crossed)

## J. Service Equipment for Signal System

The electrical service point for each signal system is shown on the Plans. The service points shown are approximate; the exact locations will be determined in the field by the Power Company and the City. See signal plan Equipment Schedule for specific service cabinet requirements at each service point.

The electrical contractor is responsible for coordinating the turn on of all permanent electrical services with the City of Minneapolis Traffic and Parking Services Division (TPS) and Xcel Energy. After State of Minnesota electrical inspection and approval of each metered electrical service location and after notification is provided to the TPS Electrical General Foreman (612-673-5759), the City will submit an application for electrical connection and meter installation to Xcel Energy.

### 1. Pad Mount Signal/Lighting Service Cabinet

The service cabinet shall be constructed in accordance with City of Minneapolis Standard Plate Nos. Traf-3500 and Traf-3631-R3 and the following:

- a. The cabinet enclosure (physical enclosure only) shall be UL listed with the UL label affixed to the inside of the cabinet, and shall carry a NEMA 3R rating to provide a degree of protection against rain, sleet, snow, and dripping water.
- b. Each cabinet shall be free of flaws, cracks, dents and other imperfections.
- c. All surfaces shall be smooth and clean.
- d. All seams and joints shall be smooth and even, without cracks, air leaks or pinholes with no sharp or jagged edges.
- e. All interior attachments to the cabinet exterior sheet metal shall be welded (i.e. no through bolts).
- f. There shall not be any sheet metal attached externally to the cabinet shell.
- g. The design, workmanship and attachment of the one-piece panel boards and dead fronts shall be a secure and aligned containment for the circuit breakers. The one-piece panel board and dead fronts shall be stamped with easily removable blank breaker cutouts to match the full capacity of the breaker panel. The panel board breaker cutouts shall precisely match the containment provisions of the breakers.

- h. The screws for attaching the cabinet dead fronts shall be of a permanent capture design to prevent lost and misplaced screws. Attachment of the dead fronts to the cabinet shall be accomplished using threaded inserts and offset cam cylinder latches.
- i. Contactors shall be normally open, NEMA rated, AC lighting contactors rated 277/480 volts with a 120-volt, 60 Hz coil, and contacts rated for 60 ampere tungsten filament load. Contactors shall be double lugged with the double lugs on the contactors installed such that field wires shall be connectable on the front lugs of the contactor. Contactors shall be installed vertically in the cabinet. Contactors shall have a positive gravity release. Contactors shall have an (off or on) condition display mechanism.
- j. The service cabinet shall have one 100 amp two-pole thermo-magnetic circuit breaker as a main breaker and single pole thermo-magnetic circuit breakers as branch breakers on each circuit panel.
- k. The Vendor shall furnish and install the following in each service cabinet:
- Two (2) **200 amp meter sockets** with disconnect.
  - One (1) bracket mounted single pole test switch rated 15 amperes at 125 volts.
  - Two (2) 60 amp two pole contactors.
  - 15 amp and 60 amp circuit breakers as indicated on details. All 60 amp multi-wire branch circuits shall have Schneider Electric / Square D QO1HT Handle Ties.
  - One (1) photoelectric cell.
  - Two (2) 12 circuit panels.
  - Power distribution terminal block.
  - Current limiting protector w/JJN-125 class T fuses
  - One (1) 120v 15/20 amp GFCI Convenience receptacle
- l. The photoelectric cell shall have normally open contacts rated 15 amperes. The photo control shall be installed within the lighting service cabinet. It shall be bracket mounted immediately behind a Plexiglas covered hole. The hole shall be located on the side of the cabinet. The hole size and location shall be as shown on the service cabinet detail. Mounting shall be as directed by the Engineer. The photoelectric control shall be in accordance with the MNDOT 3812 and have a minimum 30-second time delay capability.

- m. The electric meters shall be installed within the service cabinet as shown in the details. The electric meter sockets shall be suitable for single phase, 3 wire, 120/240 volt service with a utility approved manual bypass switch. The Utility Company will provide the electric meters. Sockets shall be provided and installed by the vendor. The placement of the meter socket and meter, door lock, and the viewing window shall permit the door to be closed, and the meter to be read electronically from outside the cabinet.
- n. Each cabinet shall have an anodized etched finish (Aluminum Association C22) with an Architectural Class 1 (Aluminum Association A42) hard coat finish of at least 0.7 mil. Finish color shall be 30 minute clear aluminum as directed by the City.
- o. Locks shall be furnished and installed by vendor. Locks shall be keyed for a standard No. 2 traffic signal key.
- p. Cabinet lifting provisions shall meet the UL requirements for the NEMA 3R cabinet. The lifting provisions shall consist of aluminum lifting ears mounted to extend above the top of the left and right sides of the cabinet enclosure, allowing a bar or hooks to be inserted through both ears for lifting the cabinet. The lifting ears shall have a lifting capacity equal to the weight of the completely wired cabinet plus 25 percent, 500 pound capacity minimum. Each lifting ear shall have a 1 inch hole, the bottom of which shall be flush with the top of the cabinet or less than 3/8 inches above the top of the cabinet. The top of the lifting ear shall extend no more than 2 to 2 & 1/8th inches above the top of the cabinet at the point where the ear is attached. The lifting ears shall be centered on the cabinet side walls such that the cabinet will not pitch or tilt when lifted. The lifting ears shall be secured to the cabinet by means of stainless steel bolts, allowing the ears to be inverted. The positioning of items mounted inside the cabinet shall not restrict access to the bolts. Ship the cabinets with the lifting ears in the up position. See detail drawing of the "Lifting Ears".
- q. No company's logo and/or advertising shall be placed on any part of the cabinet exterior.
- r. The contractor shall be responsible for creating and installing arc flash warning labels. These labels shall meet the requirements of section 110.21(B) of the National Electric Code (NEC) and NFPA 70E Standard for Electric Safety in the Workplace.. Contractor is responsible for obtaining all relevant information from Xcel Energy to perform the required calculations.

2. Temporary Pole Mount Signal/Lighting Service

The pole mount signal/lighting service shall be as shown on City of Minneapolis Standard Plate No. Traf-3520.

3. Service Lateral

Service laterals shall be as shown on City of Minneapolis Standard Plate No. Traf-3510. Conduit type & size shall be as shown on the plans.

In addition to the above the following requirements for electrical service connections to each signal system as detailed below shall apply:

- Power shall be obtained from a service lateral on a power company wood pole, ground mounted transformer, or other source as noted in the Plans (Contractor shall field verify power source).
- All service equipment, conduit, and power conductor wiring shall be replaced for all locations where signal systems previously existed and are being revised.
- When service feeds for Signal Systems are to be provided from an existing signal/street light service cabinet, the Contractor shall provide a connection to the service cabinet and all necessary cable, conduit and install any necessary circuit breakers.
- Service feeds for operating temporary signal systems shall not be disrupted until the newly constructed systems are ready to be made operational.

K. Terminal Blocks

The provisions for terminal blocks of MnDOT 2565.2JJ are modified as follows. The referenced terminal block terminals and screws shall be **nickel-plated brass** and be Kulka 603 series or equivalent. Wire lugs for terminal block connections shall be non-insulated and oversized for #10/12 THHN for #14 signal wire connections. Use Thomas&Betts Sta-kon 4 terminal C115 or city approved equal. **Do not use lugs in solid wire applications. Solid wires shall be stripped and hook bent at terminal block.**

L. Vehicle Signal Faces – Polycarbonate

1. Signal Indications:

All "Red", "Yellow", and "Green" signal indications shall utilize light-emitting diode (LED) units. MnDOT approved LED units are listed on

the MnDOT Qualified Products List on the Office of Traffic, Safety, and Operations (OTSO) WEB site for Traffic Signals:

<http://www.dot.state.mn.us/products/index.html>

2. The provisions of MnDOT 3834 (ITE Vehicle Signal Faces) are modified as follows:

The housings, housing doors, tunnel-type visors, lenses, and background shields of new vehicle signal indications and faces mounted on the traffic signal upper cantilever mast arms shall be fabricated from polycarbonate resin material in accordance with the latest issue of the ITE standard for Adjustable Face Vehicular Traffic Control Signal Heads. The housings shall be one piece with the front, sides, top, and bottom integrally molded. Each vehicle signal face shall be sectional with separate adjustable housing for each vehicle signal indication. The housings, housing doors, visors, and background shields on overhead mast arms and on vertical pole shaft and pedestal-mounted signals shall be black in color. The color shall be completely impregnated in the resin material and scratches shall not expose uncolored material.

- a. The housing unit shall be sealed at the top bracketing connection point with a rubber gasket and shall be watertight.
- b. A.C. or D.C. voltages at the input terminals of the LED indication shall be below 15 volts within 200mS after removing power. The indication shall work with a conflict monitor utilizing NEMA plus functions, specifically DUAL INDICATION.

Background shields shall only be installed with overhead mast arm mounted signals unless otherwise noted in the plans.

All vehicle signal faces with LED indications shall be approved by the City prior to procurement.

Support plates shall be furnished with each overhead mast arm mounted vehicle signal face to distribute stresses evenly over the ends of the vehicle signal face. Also, a plumbizer adapter in conformance with MnDOT Standard Plate No. M8124E shall be furnished with each overhead mast arm mounted vehicle signal face. Support plates and plumbizer adapters shall be black in color.

For each LED signal indication, the Contractor shall submit to the Engineer, for approval, four copies of all warranty information indicating the required 6-year warranty period (**from date of installation**), product invoice, and documentation indicating name of

manufacturer, model number, and serial number. The four copies shall be distributed by the Engineer as follows:

- City of Minneapolis Traffic Division (2 copies)

For all LED signal indications, the manufacturer shall provide the following warranty provisions:

- a. Replacement or repair of an LED signal module that exhibits a failure due to workmanship or material defects within the first 72 months of field operations.
- b. Replacement or repair of "RED", YELLOW and "GREEN" LED signal modules that fall below the requirements for ITE

**The Contractor shall, to the satisfaction of the Engineer, affix to the back of each "LED" signal indication a permanent label, or permanently marked (utilizing a "oil based paint marker") with the actual date of installation. The oil based paint marker shall be a contrasting color to ensure that the date can be easily read.**

M. Programmable Vehicle Signal (Special Signal Faces)

This defines minimum standards for product performance and composition relating to 12 inch LED Programmable Vehicle Signal Heads, hereinafter referred to as PSH.

1. General

The PSH shall provide an indication to the field of view providing a visibility zone of red, yellow and green, without requiring louvers or other external blocking devices to achieve the end result. No indication shall result from external illumination nor shall one section illuminate another. The housing/sections shall be weatherproof and dust-tight. The signal shall display indications of red, yellow, and green - balls or arrows. The PSH when configured shall operate directly from 120-volt, 60 Hz power source. All PSH components including lenses, reflectors, wiring, and materials used in the construction of PSH assemblies shall meet or exceed all applicable ITE Specifications with exceptions outlined in these specifications.

Each PSH shall be provided with a black single piece metal background shield.

2. Construction

A. Color



The exterior of each signal housing shall be colored BLACK with a lusterless finish. External color of the housing shall be completely impregnated in the resin material so that scratches will not expose uncolored material.

B. Housing

Each housing section shall be manufactured with cast aluminum, type 360, reduced corrosion, and increased powder coat adhesion. Housing shall be reinforced with ribs on top and bottom for extra rigidity. Dimensions 13.3" H x 13.3" W x 18.0" D (1 section).

C. Door Assembly

The door hardware shall consist of stainless steel door roll pins and eye bolt/wing nut assemblies. Access shall be provided with one (1) front door and one (1) rear door. The doors shall be moisture proof. A dust tight neoprene gasket shall be fitted to the gasket channel cast in the door perimeter.

D. Optic Lens

The lens shall be acrylic and colored to ITE specifications. The 12 inch dome shall have a diameter between 11-15/16 (11.9375) inches and 12 1/32 (12.03125) inches. The lens shall diffuse the light emanating from the LED's to provide light disbursement across the outer dome. In no instance shall individual LED's be visible in the field of vision when the signal section is energized. The PSH shall be designed to allow the light output through the lens to be directed or steered into a specific viewing zone.

3. Programming

Each programmable signal head shall be capable of being individually addressed and programmed. Programming shall be accomplished through the use of a Fresnel lens and a smaller clear lens. The directional beam shall be focused by masking off portions of the smaller lens which controls the signal faces each lane sees when approaching the signal. The signal section shall be able to tilt in two degree increments up to ten degrees below the horizontal axis while still maintaining a common vertical access. All required masking equipment shall be included. Only the green indication shall be dimmed such that it is visible only after the upstream intersection.

4. Environmental

The PSH, when assembled, shall be weather-proof and dust tight. The PSH shall operate over the temperature range of -34 degrees "F" to +165 degrees "F" (-37 degrees "C" to +74 degrees "C").

5. Identification

Each PSH shall be marked with the manufacturer's name. Each PSH LED module shall be identified by a manufacturer's serial number for warranty purposes.

6. Warranty

Manufacturer shall warrant the PSH, to be free from defects in material and workmanship for a minimum of 5 (five) years from date of shipment from the manufacturer. Warranty shall cover repair or replacement of defective parts only, and shall be at the discretion of the manufacturer.

N. Pedestrian Signal Faces with Countdown Timers - Polycarbonate

Each pedestrian signal indication of each pedestrian signal face shall be a single section. The size shall be nominal 16 inch x 18 inch as called for in the Plans and the indication shall utilize the international hand and walking person illuminated message and countdown timer. Each pedestrian signal face housing, housing door, and visor shall be black in color. The color shall be completely impregnated in the resin material and scratches shall not expose uncolored material.

1. Housing

Unused mounting holes shall be plugged to provide a watertight seal. A plug shall be provided for the bottom-mounting hole which the pedestrian signal shall have mountings to properly fit brackets made of 1.5-inch pipe. The openings shall have a common vertical centerline through the housing to permit 360-degree rotation of the mounted pedestrian signal. The housing unit shall be sealed at the top bracketing connection point with a rubber gasket and shall be watertight. The mounting brackets shall serve as the electrical conduit for the pedestrian signal.

No terminal blocks are to be used in pedestrian heads. Use wire nut splices as the approved method.

2. Visor

Each signal head shall have a removable tunnel type visor for each signal indication. The visor shall be fabricated from black polycarbonate resin material and shall encompass the entire top and sides (bottom open) of the pedestrian signal face. The visor shall be designed to fit tightly against the door so as to prevent any perceptible

filtration of light between the door and the visor. The top of the visor shall have a downward tilt of approximately 3-1/2 degrees. The length of the visors shall be a minimum of 9 inches with all sides of the visor approximately the same length. Visors shall be secured by at least six stainless steel screws.

3. Optical Unit

The pedestrian indications module with countdown timer shall utilize light-emitting diode (LED) units and shall be listed on the MnDOT Qualified Products List on the Office of Traffic, Safety, and Operations (OTSO) WEB site for Traffic Signals:

<http://www.dot.state.mn.us/products/index.html>

- a. Module shall be constructed for installation within the signal housing assembly without any modification to either the housing assembly or the LED module.
- b. Each unit shall be labeled with the manufacturers trademark, identification number, voltage rating and up arrow indication.
- c. Insulation displacement connectors shall not be used.
- d. Under no circumstances shall a “Walk” indication supersede a “Don’t Walk” indication when any amount of voltage is applied to both inputs.
- e. The LED unit shall include a one piece neoprene or EPDM (Ethylene, Propylene, Diene Monomers) gasket which shall make an assembled housing and LED module watertight.
- f. A.C. or D.C. voltages at input terminals of the L.E.D. shall be below 15 volts within 200ms after removing power. The indication shall work with a conflict monitor utilizing N.E.M.A. plus functions, specifically DUAL INDICATION.
- g. Each module shall have one opening located in each of the four corners to secure the module to the housing assembly door.
- h. Each LED module shall use wire nuts instead of terminal strips in LED heads.
- i. The manufacturer shall provide the following warranty provisions:
  - Housing Assemblies furnished shall be guaranteed to be free from electrical, mechanical, or structural defects for a period of 18 months from the date of delivery, and any such defects

developing within warranty period shall be remedied free of all expense to the City.

- LED modules shall have a minimum 6-year (72-month) warranty period from the date of installation. The warranty shall cover the replacement cost including the price of the unit and shipping. This warranty shall cover the replacement or repair of any LED signal module that exhibits a failure due to workmanship or material defects or falls below the minimum intensity levels.
- The Contractor shall, to the satisfaction of the Engineer, affix to the back of each pedestrian signal indication a permanent label or permanently marked (utilizing an “oil based paint marker”) with the actual date of installation. The oil based paint marker shall be a contrasting color to ensure that the date can be easily read.

#### 4. Painting

All surfaces of the pedestrian signal housing and housing door shall be black in color. All surfaces of the visor shall have a dull non-reflective black finish.

The color shall be completely impregnated in the polycarbonate resin material of the molded parts such that scratches will not expose uncolored material. Color to be approved by the City prior to manufacture.

#### 5. Manufacturer's Drawings, Specifications, and Sample Unit

The Contractor shall submit to the Engineer for approval by the City one (1) module and electronic pdf file of manufacturer's drawings and specifications of the pedestrian signal face. The supplier shall also provide at the time of submission of unit for approval written certification in the form of independent test results that the pedestrian indication equipment to be supplied meets or exceeds ITE performance requirements for intensity and color.

The Contractor shall also submit to the Engineer, for approval by the City, electronic pdf file of all warranty information, a Manufacturers' Certificate of Conformance to this specification, and all other pertinent manufacturer data. As part of the pertinent manufacturer data, the Contractor shall include the product invoice.

The Engineer shall distribute electronic copies of the above documents as follows:

- City of Minneapolis Traffic and Parking Services

6. Inspection

The pedestrian signal shall be approved by the Engineer prior to procurement by the Contractor.

O. Luminaires on Signal Poles

The luminaires located on the luminaire extension on mast arm signal poles shall be furnished and installed under the signal portion of the Contract. All work related to luminaires installation on street light poles shall be furnished and installed under the street lighting portion of the contract. The luminaire fixture and slipfitter are described in the Lighting portion of the Special Provisions.

All circuit wiring to streetlight poles that are utilized as traffic signal standards shall be furnished and installed under the lighting portion of the Contract. Wiring from the transformer base to the luminaire (2-1/c#12 AWG stranded wires with THHN/THWN rating) shall be furnished and installed under the signal portion of the Contract. One conductor shall have insulation colored black, and the other shall have white colored insulation.

Street lights shall be fused in accordance with Plan details. Fuses and fuse holders shall be "UL" listed. Fuse holders shall be Homac Ferraz-Shawmut in-the-line waterproof FEB-11-11 with a Type SLK-6FSB-1 waterproof boot with and a Bussman BAF-10 single element fuse, or Cooper Bussmann, Inc. HEB-AW-RLC-A, and a Bussman BAF-10 single element fuse, or City of Minneapolis approved equal.

If the signal system is adjacent to a street lighting system, the luminaires shall be tied into the street lighting circuit using Minneapolis standard #4 combo wire. If there is no adjacent street lighting, luminaires shall be powered by 3/c#12 type UNTC cable controlled by photo eye.

P. Concrete Foundations/Bases

Concrete for all foundations shall be Mix No. 3Y43 free of chloride additives, placed and consolidated using vibratory equipment. **All square foundations shall be broom finished on all sides and edged with a ½" edger. All round foundations shall be chamfered with a ½" radius edger and broom finished on top**, all in accordance with the provisions of MnDOT 2565.3F. Concrete shall be allowed to cure for a minimum of seven (7) days before being placed into use unless otherwise permitted by the Engineer. Overhead pole bases shall include (2) 3" conduits for signal wire and (2) 2" conduits for present or future streetlight connections.

All bases shall be level, flush and centered on the foundation cap.

Q. Intersection Controller and Cabinet

The City will furnish and install all traffic signal controllers and cabinets complete with all internal control equipment, including Contractor furnished EVP & Video Detection equipment (if required in the plans), for use on this project at each system.

R. Availability of Materials

Push button poles and bases and Minneapolis Standard fluted pedestal signal poles and bases that meet the requirements of these Special Provisions are available and may be purchased from the Minneapolis Traffic and Parking Services, depending upon the timeliness of the order, and availability of the material in City stock. Contact the Traffic Stores office at 612-673-5752.

**SS-1.3 Construction Requirements****A. Staging**

The Contractor shall provide proposed staging plan for all revised signal system and pedestrian curb ramp work at each intersection to the Engineer for approval prior to commencing work, and shall plan his work accordingly.

**B. Conduit Placement**

Where N.M.C. conduits are required to be placed underground below roadway surface areas that are to be reconstructed with bituminous or concrete pavement, the N.M.C. conduit shall be placed and backfilled (if trenching method used) and compacted to the satisfaction of the Engineer before any new pavement is placed.

Exposing existing utilities and surface restoration shall be considered incidental to the work required to provide a complete conduit system installation.

The Contractor shall install red City of Minneapolis Traffic and Parking Services marking tape for marking underground transportation utilities at a distance of 6 inches above all new conduit placed by the trenching method. The required marking tape shall be purchased by the Contractor at the City of Minneapolis Traffic and Parking Services Office, 300 Border Avenue North. Provision and installation of the marking tape by the Contractor shall be considered incidental work to furnishing and installing the conduit.

Existing conduit to be reused as part of a revised permanent signal system (as shown in the Plans) shall be reused in accordance with the provisions of MnDOT 2565.3D5.

1. Extension of Conduits: The Contractor shall provide a continuous length of conduit of size and type noted on the Plans between the specified terminal points.
2. Installation of Conduit into Handhole: Conduits shall be installed into handholes by use of a hole saw to cut through the handhole wall. Areas surrounding conduit entrances shall be sealed by filling them with mortar. Conduits shall be installed entering handholes through the sidewalls of the handholes, **not through the bottom gravel foundation.** Conduits shall extend a minimum of 2 inches and no more than 3 inches into the handhole.
3. Connection to Existing Conduits: The Contractor shall locate the ends of existing conduit as shown on the Plans and extend the conduit to handhole, signal base, etc., which is to be built by the Contractor.

Existing conduit shall be cut perpendicular to conduit and exterior surface cleaned to form secure connection to extension.

4. Installation of Conduits: The conduits shall be installed a maximum of 12 inches from the back of the curb, as shown in the Plans or as directed by the Engineer. Except as required to bypass foundations, the base on which the curb is placed shall not be disturbed. All conduits installed across newly surfaced streets shall be installed at a minimum depth of 24 inches or as directed by the Engineer.

Where existing sidewalks, pavement, or streets are opened, the opening shall be refilled to the original thickness using material equal to that removed, and the surface restored. In sidewalk areas whole panels shall be removed and replaced unless a utility joint exists in which case only the portion of the walk above the installation up to the joint need be removed and replaced.

In general, all conduits shall be straight and true, and all offsets and bends shall be uniform and symmetrical. **No more than 360 degrees of bends in any runs, no more than 180 degrees at any corner, and no 90 degree turns in handholes or fiber vaults. Underground conduits to follow plans as much as possible. Addition of any bends or offsets must be discussed with Traffic engineer or representative from City of Minneapolis and approved by the engineer.** All directionally bored conduit shall be bored directly from foundation to foundation. Foundations, handholes and vaults must be staked before commencing underground boring operations. Field bends of conduit shall only be accomplished with the use of an approved conduit heating/bending mechanism designed for that purpose. The Contractor shall adjust the elevations of the conduit assembly for its full length to approximately the same gradient as the finished roadway, and shall furnish and install, in the trench such suitable spacers and framing as may be necessary to maintain the correct grade and alignment. The cover material shall be firmly tamped into place in 6-inch lifts to minimize uneven settlement above or below the conduit.

5. Installation of Conduits Under Driving Surface and Sidewalk: All conduits that are to be placed under driveways, streets and sidewalk that are not scheduled for removal shall be directional bored, or installed by another method approved by Engineer that will not damage or disturb the integrity of the driveway, street or sidewalk. All conduits that are to be placed under driveways, alleys, streets, or sidewalk that are scheduled for removal must be placed during the time between the removal of the existing surface and the commencement of pavement operations. The Contractor is responsible for coordination with the paving Contractor.
6. Installation of Conduits Under Driving Surface and Sidewalk Outside Paving Limits: All conduits that are placed under driveways, streets and sidewalk that are not scheduled for removal as part of the street or



sidewalk paving shall be placed either by directional boring, surface removal or other approved methods. Any required surface removal and restoration shall be considered incidental to the work required to provide a complete conduit system installation. Damage to pavement or sidewalk shall be remedied at the Contractor's expense.

7. Conduit Attached to Wood Poles (Service): All conduits terminating near the top of a wood pole shall utilize a metal riser as shown in standard plate TRAF-3510. Conduit shall be attached to a wood pole by galvanized RSC straps spaced 3 feet apart, or as directed by the Engineer.
8. Duct Seal: Duct seal or other Engineer approved material shall be furnished and installed to seal all controller cabinet and service cabinet conduit entrances as necessary in accordance with MnDOT 2565.3D2b.
9. Conduit Ends in Handholes: All ends of non-metallic conduit entering a handhole shall be trimmed by the Contractor, on the inside and outside of cut ends to remove rough edges. Conduits shall extend a minimum of 1 inch and no more than 2 inches into the handhole.

C. Concrete Traffic Signal Pole and Cabinet Foundations

All foundations shall be cast in place. Use of precast foundations is not permitted.

The concrete traffic signal cabinet foundations for the City furnished and installed traffic signal cabinets shall be installed in accordance with the details as shown on the detail sheets in the Plans. All foundation locations shall be approved by the City before construction.

Concrete pad finishing shall be broom finished on all exposed sides, level, and edged with a ½ inch edger. No more than 0.125 inches of variability compensated by shims will be allowed. Variability in excess of this will require resurfacing or replacement at the direction of the Engineer. Inspections will be performed using a Contractor supplied City approved ½" thick steel template manufactured to match cabinet dimensions. The first pad shall be inspected in detail, approved and used as the standard for finish and workmanship. All templates required are incidental to the project.

All foundations shall be constructed such that the top of the foundation is at least 3 inches above the grade of the surrounding poured concrete. All bases shall be level, flush and centered on the foundation cap.

D. Loop Detector Installation

Where loop detectors are required to be installed in roadways surfaced with new bituminous pavement, the loop detectors shall be installed before paving forces place the bituminous wearing course.

Detector locations identified as sampling detectors shall be constructed using standard loop detector installation procedures.

All loop detectors shall be NMC except that they may be saw cut at specific locations if so authorized by the City.

1. NMC Conduit

The Contractor shall install loop detectors in accordance with the applicable provisions of MnDOT 2565.3G and MnDOT Standard Plate Minneapolis Standard Plate No. 81765 “Preformed Rigid PVC Conduit Loop Detector”.

After completion of the installation, the loop shall be final tested, as described below. The completed sealed loop must pass frequency, inductance, and resistance tests prior to being accepted.

The Contractor shall splice roadway loop detector conductors in accordance with the procedure outlined below to loop detector lead-in cable conductors in the handhole or junction box adjacent to the loop detector and shall make each new loop detector operational. Lead in cable shall be installed in a continuous run from handhole to the controller cabinet with no intermediate splices permitted.

Slack loop detector lead-in cable, 10-feet in length, shall be left in each handhole through which a run of cable passes. All other applicable provisions for wiring in accordance with MnDOT 2565.3J shall apply.

The loop detector roadway conductors and the loop detector lead-in cable conductors shall be properly prepared and cleaned before splicing.

Prior to installing the approved loop detector splice kit, the Contractor shall solder the ends of the loop detector lead-in conductors to the roadway loop detector conductors, and shall furnish and install an appropriate sized wire nut to the soldered ends prior to installation of the splice kit.

Splice kits shall be installed in handholes in such a manner as to ensure that each splice kit is suspended and/or secured near the top of the handhole to the satisfaction of the Engineer (**placing splice kits on top of the electrical cables and conductors is NOT acceptable**).

2. Saw Cut

Saw cut loops shall be saw cut in the roadway in accordance with City of Minneapolis Standard Plate No. Traf-1760; with the Plans; with the provisions of MnDOT 2565.3G as directed by the Engineer and the following:

Loops shall be installed by saw cutting a slot in the pavement, installing the loop wires in the saw cut, sealing the wires and filling the saw cut with loop sealant and extending the wires under the curb into a handhole in accordance with City of Minneapolis Standard Plate No. Traf-1760.

The saw shall be equipped with a depth gauge and horizontal guide to assure proper depth and alignment of the slot. The blade used for the saw cut shall provide a clean, straight, well-defined 0.4-inch wide saw cut without damage to adjacent areas. The depth of the saw cut shall be a minimum of 2 inches, and deep enough to provide 1.5 inches of cover above the conductors. Where the loop changes direction, the saw cuts shall be overlapped to provide full depth at all corners. Corners shall be drilled with a 1 3/4-inch diameter drill, and drilled to a depth of 1/4 inch deeper than the saw cut.

Before installing the loop wire, the saw cuts shall be checked for the presence of jagged edges or protrusions. Should these exist, they must be removed. The slots must be cleaned and dried to remove cutting dust, grit, oil, moisture or other contaminants. Cleaning shall be achieved by flushing clean with a stream of water under pressure, and following this, the slots shall be cleared of water and dried using oil free compressed air.

Loop detector conductors shall be installed using a 1/5 inch to 1/4-inch thick wood paddle. If the wire does not lie close to the bottom of the saw cut, it shall be held down by means of a material such as tape or Styrofoam.

Each loop shall have its wire coiled clockwise and the beginning conductor banded in the terminating handhole with a symbol to denote start of conductor. Each loop shall be further identified by number with durable tags, or as directed by the Engineer.

The field loop conductors installed in the pavement shall run continuously with no splices permitted.

After obtaining satisfactory test results, the loop shall be sealed with a flexible embedding sealer. The sealer shall be used strictly in accordance with the manufacturer's instructions. The sealer shall be poured into the slot to half depth. When both the loop and lead-in slots are half filled, check for air bubbles, for material pile-up, and then proceed to fill the slots to roadway level. Excess sealant shall be removed by means of the "squeegee." In all cases, there shall be neither a trough nor a mound formed. The sealer, when poured into a saw-cut, should completely surround the wires, displace all air therein and completely fill the area of the slot, except for that portion filled with the wire hold down material. Allow sufficient time for the sealer to harden in accordance with manufacturer's instructions before allowing traffic to move over the area.

After completion of the sealing, the loop shall be final tested, as described. The completed sealed loop must pass frequency, inductance, and resistance tests prior to being accepted.

All lengths of loop wires that are not imbedded in the pavement shall be twisted with at least five (5) turns per foot, including lengths in conduits and handholes.

Each loop shall terminate individually in the handhole and shall be taped to exclude moisture.

The saw cut configuration, depth, width, number of turns and labeling of wire ends shall be done in conformance with the City of Minneapolis Standard Plate No. Traf-1760.

The City will mark with spray paint the location and orientation of each loop to be installed on the pavement. The location of the handhole will also be identified.

Each loop detector of size 6 ft. x 6 ft. shall have 3 turns of wire.

Loop sealant shall be the black colored Detector Loop Sealant manufactured by 3M, Traffic Control Devices Safety and Security Systems Division, St. Paul, Minnesota. Material, which has exceeded the label expiration date, shall not be used.

Non-metallic conduit and fittings shall be Type II heavy-wall rigid PVC Schedule 40 and shall bear the Underwriters Laboratories, Inc. (UL) label.

The Contractor shall splice roadway loop detector conductors to loop detector lead-in cable conductors in the handhole or junction box adjacent to the loop detector and shall make each new loop detector operational. Lead in cable shall be installed in a continuous run from handhole to the controller cabinet with no intermediate splices permitted.

Slack loop detector lead-in cable, 10-feet in length, shall be left in each handhole through which a run of cable passes. All other applicable provisions for wiring in accordance with MnDOT 2565.3J shall apply.

#### E. Loop Detector Splice

The following splice procedure shall be utilized in connecting the loop lead and the lead-in conductors. This connection shall be made only in a detector handhole, signal base, or cabinet as shown on the Plans.

The electrical splice between the lead-in cable to the controller and the loop wire shall be soldered using resin core solder and provided with a watertight protective covering which covers the spliced wire, the shielding on the loop

lead-ins and the end of the tubing containing the loop wires. The use of open flame to heat the wire connection will not be permitted. The Contractor shall use a soldering iron, gun, or torch equipped with a soldering tip. The splice shall be made by the following method:

1. Remove all lead-in coverings leaving 4 inches of insulated wire exposed.
2. Remove the insulation from each conductor of a pair of lead-in cable conductors and scrape both copper conductors with knife until bright.
3. Remove the insulation from the loop wires and scrape both copper conductors with knife until bright.
4. The conductors shall be connected by a soldered pigtail-type splice, wrapped with waterproof tape, and encapsulated in a splice encapsulation kit.
5. The Contractor shall use a **3M Company DBR 6 Kit** for splices.
6. Splices in handholes shall have the splice kit suspended vertically and secured near the top of the handhole with loop and lead-in conductors at the lower end of the kit. Splicing and placement shall be to the satisfaction of the Engineer.

Conductors for inductive loop installations shall be individually identified and banded in pairs by lane, in the handhole adjacent to the loops. The loop detector lead in conductors shall be similarly identified at the cabinet.

F. Loop Detector Test Report

The Contractor shall furnish to the Engineer, in triplicate, a signed and dated "Loop Detector Test Report" for each loop detector and lead in cable system furnished and installed as part of this Contract with the following information.

1. Project Numbers and Intersection location.
2. Loop Detector Number (as shown in the Plans) Dimensions of Loop Detector (Length and Width in feet) as installed, and Number of Turns of wire in Loop Detector as installed.
3. Continuity Test: Each loop detector circuit shall be tested for continuity at two (2) locations: (1) Loop detector at the handhole prior to splicing with the loop detector lead-in cable (shall have a value less than 0.5 ohms), and (2) Loop detector and lead-in cable system at the traffic signal cabinet after splicing in the handhole (shall have a value less than 5 ohms). The continuity test ohm reading at the traffic signal cabinet

shall be greater than the ohm reading measured at the loop detector adjacent handhole.

4. Inductance Test: Each loop detector and lead-in cable system shall have an inductance test measured at the traffic signal cabinet. The inductance shall be in the range of from 50 to 200 microhenries, depending upon loop size, number of turns, lead-in length, etc. Field-measured inductance readings shall not vary by more than  $\pm 20$  percent from theoretical calculated inductance.
5. Insulation Resistance Test: An insulation resistance test at 500 volts direct current shall be made at the traffic signal cabinet between one loop detector lead-in conductor and the "Equipment Ground Buss" in the cabinet. The insulation resistance shall have a value of not less than 100 megohms.
6. Resonant Frequency Test: The resonant frequency of the loop shall be determined by the use of a loop frequency tester. The resonant frequency shall remain stable when there is no vehicle activity in the area and shall not drift more than plus or minus one hertz per minute.

NOTE: The Continuity Test, Inductance Test, Insulation Resistance Test, and Resonant Frequency Test to be conducted at the traffic signal cabinet shall be performed before the loop detector lead-in conductors are terminated on the terminal facilities provided in the cabinet. The tests shall be performed in the presence of the Engineer and a designated City of Minneapolis Traffic and Parking Services representative.

All loop detector tests shall be made by the Contractor, at his own expense, to demonstrate that the materials and installation of each loop detector and lead-in cable system are in accordance with the requirements of the Plans and these Special Provisions. The tests shall be conducted in the presence of and to the satisfaction of the Engineer. The Contractor shall provide such electrical instruments, apparatus, tools, and labor as may be necessary to make the required loop detector tests on each loop detector and lead-in cable system. Such electrical instruments, apparatus, and tools shall remain the property of the Contractor after the tests are completed.

In the event that a loop detector and/or lead-in cable system "fails," any one of the above-mentioned loop detector tests, the Engineer may direct the Contractor to replace any part of or the entire loop detector and lead-in cable system at the Contractor's own expense. No Supplemental Agreement will be written for replacing any part of or the entire loop detector and lead-in cable system. All of the above-mentioned loop detector tests shall be repeated and recorded for the "revised" loop detector and lead-in cable system.

Each loop detector and lead-in cable system furnished and installed as part of this Contract shall “pass” the above-mentioned loop detector tests.

A suggested format for the “Loop Detector Test Report” is shown below. A blank Test Report is included in the Appendix.

**--- S A M P L E ---**

**LOOP DETECTOR TEST REPORT**

STATE PROJECT NO. S.A.P. 27-681-11; 27-681-12; S.A.P. 141-020-098; 141-020-102

INTERSECTION West Broadway at Penn Avenue North

LOCATION I.D. Minneapolis

No.	Loop Detector Number	Dimensions (in feet)		Number of Turns	Continuity (in Ohms)		Inductance (microhenries)	Insulation Resistance (megohms)	Resonant Frequency (Hertz)
		Length	Width		Loop	Cabinet			
1	D1-1	6 6 6 6	6 6 6 6	3	0.1 0.1 0.1 0.1	2.5	80	180	25K
2	D5-1	6 6 6 6	6 6 6 6	3	0.1 0.1 0.1 0.1	2.5	80	180	30K
3	D4-1	6	6	3	0.1	1.8	150	200	25K
4	D4-2	6	6	3	0.1	1.8	150	200	25K
5	D8-1	6	6	3	0.1	1.5	150	150	25K
6	D8-2	6	6	3	0.1	1.5	1.50	150	25K

**--- E. T. C. ---**

- NOTES: 1. No. 3, 4, 5, and 6 in the above sample report, are an example of a single loop detector and lead-in cable system.  
 2. Nos. 1 and 2, in the above sample report, are an example of a multiple loop detector and lead-in cable system.

The Project Engineer shall distribute the three (3) final loop detector test reports as follows:

- (01) Original report to the official project file
- (02) Copy to the traffic signal cabinet
- (03) Copy to the City of Minneapolis



G. Video Detection System Type 1

Type 1 Detection no longer used.

H. Video Detection System Type 2

The Contractor shall furnish, install and make operational all video detection devices for Signal Systems as shown in the Plans and as follows. The Contractor shall furnish and install all cables and conductors, mounting hardware, and each video detection device as per the Plans and to the satisfaction of the Engineer.

All equipment necessary as well as the equipment in each controller cabinet to operate each video detection system shall be new devices furnished and installed by the Contractor.

At least 14 days prior to when the traffic signal cabinet is required on the project, all necessary materials and electrical equipment required in the traffic signal cabinet, and all documentation, maintenance and operation manuals, and wiring diagrams shall be delivered to the TPS Electrical General Foreman (612-673-5759) at the City of Minneapolis Signal Shop at 300 Border Avenue North, Minneapolis, MN 55405.

1. General

This specification sets forth the minimum requirements for a system that detects vehicles on a roadway using only video images of vehicle traffic.

a. System Hardware

The video detection system (VDS) shall consist of up to four video cameras, up to four video detection processors (VDP) modules capable of processing one video source each, one Central Control Unit (CCU), input/output extension modules, video surge suppressors, and a wireless pointing device.

b. System Software

The system shall include software that discriminately detects vehicles and bicycles in single or multiple lanes using only the video image. Detection zones shall be defined using only an embedded software application. A monitor, keyboard, and a pointing device are used to place the zones on a video image. Up to 32 detection zones per camera shall be available. A separate computer shall not be required to program the detection zones. In addition to creating vehicle and bicycle zones, the system shall automatically define a pedestrian crossing area in front of the stop bar zones. The system shall provide a tracking mechanism

that counts pedestrian volume moving within this crossing area, and also determine the average, maximum, and minimum speed of pedestrians moving within this crossing zone.

- c. The VDS shall be made in the U.S.A. in compliance with FTA “Buy America” regulations.

## 2. VDS Hardware

The VDP shall be a single-rack detector card width, and provide provision for up to two sensors per VDP. The following interfaces shall be provided on each video detection processor

Each VDP will be supplied with video from the VDS Camera Sensor via Ethernet cables plugged into the front of the Central Control Unit. The interface connectors shall be RJ-45 type.

A LED indicator shall be provided to indicate the presence of the video signal. The LED shall illuminate upon valid video synchronization and turn off when the presence of a valid video signal is removed.

Open collector (contact closure) outputs shall be provided. Four (4) open collector outputs shall be provided for the Video Detection Processor rack-mount configuration. Additionally, the VDS shall allow the use of extension modules to provide up to 32 open collector contact closures per camera input. Each open collector output shall be capable of sinking 30mA at 24VDC. Open collector outputs will be used for vehicle detection indicators as well as discrete outputs for alarm conditions. The VDP outputs shall be compatible with industry standard detector racks assignments.

Logic inputs such as delay/extend or delay inhibit shall be supported through the appropriate detector rack connector pin or front panel connector in the case of the I/O module. For VDPs and extension modules, 4 inputs shall be supported via detector rack interface. The I/O module shall accommodate eight (8) inputs through a 15-pin “D” connector.

Detection status LEDs shall be provided on the front panel. The LEDs shall illuminate when a contact closure output occurs. Rack-mounted video processors shall have a minimum of four (4) LEDs. Rack-mounted extension modules shall have two (2), four (4) or eight (8) LEDs (depending upon extension module type) to indicate detection.

The front panel of the VDP shall have detector test switches to allow the user to manually place vehicle and bicycle calls on each VDP output channel. The test switch shall be able to place a momentary call.

Both the VDP and EM shall be specifically designed to mount in a standard detector rack, using the edge connector to obtain power, provide contact closure outputs and accept logic inputs (e.g. delay/extend). No adapters shall be required to mount the VDP or EM in a standard detector rack and no rack rewiring shall not be required.

VDP printed circuit boards (PCBs) shall be conformally coated in accordance with Caltrans and NEMA specifications.

The VDP shall utilize non-volatile memory technology to store on-board firmware and operational data.

The CCU shall enable the loading of modified or enhanced software through either the Ethernet or front-panel USB port (using a USB thumb drive) and without removing or modifying the CCU hardware. The upgrade will affect both the CCU and VDP hardware when connected into a single system.

The VDP and EM shall be powered by 12 or 24 volts DC. VDP and EM modules shall automatically compensate for either 12 or 24 VDC operation. VDP power consumption shall not exceed 7.5 watts. The EM power consumption shall not exceed 3 watts.

The VDS shall operate satisfactorily in a temperature range from -30° F to +165° F (-34° C to +74° C) and a humidity range from 0%RH to 95%RH, non-condensing as set forth in NEMA specifications.

### 3. Central Control Unit (CCU)

The VDS Central Control Unit (CCU) shall be supplied by the VDS manufacturer.

The CCU shall be supplied in a standard One (1) Rack Unit (1U) 19" rack format. There shall be brackets to allow the CCU to be mounted under shelves where a 19" frame is not available.

The CCU shall be powered from an 110V or 230V, 50Hz or 60Hz supply. CCU power consumption shall not exceed 20 Watts

The VDS shall operate satisfactorily in a temperature range from -30° F to +165° F (-34° C to +74° C) and a humidity range from 0%RH to 95%RH, non-condensing as set forth in NEMA specifications.

The CCU shall utilize non-volatile memory technology to store on-board firmware and operational data.

The CCU shall incorporate video surge suppression for each video input. The CCU shall be appropriately grounded to the cabinet ground rod using 14 AWG (2.5mm<sup>2</sup>) minimum.

The CCU shall incorporate power surge suppression both on the input power and on the power supplied to the cameras. The CCU shall be appropriately grounded to the cabinet ground rod using 14 AWG (2.5mm<sup>2</sup>) minimum.

The CCU shall incorporate power management for the various parts of the VDS such that if fault conditions are detected the power supply will safely shut down the power to that peripheral.

Extension modules (EM) shall be available to eliminate the need of rewiring the detector rack, by enabling the user to plug an extension module into the appropriate slot in the detector rack to provide additional open collector outputs. The EM shall be available in both 2- and 4-channel configurations. EM configurations shall be programmable from the CCU. A separate I/O module shall also be available having 32 outputs through a 37-pin "D" connector on the front panel and 8 inputs through a 15-pin "D" connector using an external wire harness for expanded flexibility.

The CCU shall provide four ports for connection to VDS camera sensors. The connector shall be an RJ-45 type.

The CCU shall provide four ports for connection to VDPs. The connector shall be an RJ-45 type.

The CCU shall provide 2 USB 'A' ports on the front panel of the rack mount CCU unit. These ports can be utilized for various functions. For example, keyboard and mouse functions during system configuration, USB storage devices can be utilized for bin data and video collection. The USB ports shall not require special mouse software drivers. The USB ports shall be used as part of system setup and configuration

The CCU shall provide an output to a monitor. The port shall be HDMI. The native resolution of the monitor port shall be 1024 x 768.

An Ethernet communications port shall be provided on the front panel. The Ethernet port shall be compliant with IEEE 802.3 and shall use a RJ-45 type connector mounted on the front panel of the CCU. The Ethernet communications interface shall allow the user to remotely configure the system and/or to extract calculated vehicle/roadway information. The interface protocol shall be documented or interface software shall be provided. Each VDS shall have the capability to be IP addressable. The VDP shall support data rates of up to 100Mbps.

The CCU shall provide an SDLC connection to the Traffic Controller. The connector shall be a 'D-15' type, in compliance with NEMA TS-2 specifications.

The CCU shall provide an indicator when the SDLC port is active.

The CCU shall provide an indicator when the unit has power.

The CCU shall provide an indicator when the unit is on line.

The CCU shall provide a Wi-Fi connection. The connection shall be over a standard 2.4GHz connection. The Wi-Fi connection shall be enabled and disabled by a switch on the CCU. The CCU shall provide an indicator when the Wi-Fi connection is active.

The CCU shall provide a connection for a removable antenna. The antenna connection shall be a SMA Male type.

The CCU shall provide system status via an on-board Organic Light Emitting Diode display. The display shall indicate various system parameters, such as camera health and VDP health, firmware version and camera air temperature. The display will be enabled with a switch on the CCU. The display will automatically disable 15 minutes after the button is pressed.

#### 4. Video Detection Camera

The video cameras used for traffic detection shall be furnished by the VDP supplier and shall be qualified by the supplier to ensure proper system operation.

The VDS camera sensor shall utilize a single shielded CAT5E or CAT6 cable for power and video. Cable termination at the camera shall not require crimping or special tools. The cable termination shall only require a standard wire stripper and a screw driver. No connectors (e.g. BNC) shall be allowed.

The camera sensor shall allow the user to set the focus and field of view via the VDS software. Camera sensor control from the controller cabinet shall communicate over a single Cat-5e or CAT6 cable. No additional wires shall be required.

The camera shall produce a useable video image of the features of vehicles under all roadway lighting conditions, regardless of time of day. The minimum range of scene luminance over which the camera shall produce a useable video image shall be the minimum range from nighttime to daytime, but not less than the range 0.003 lux to 10,000 lux.

The camera electronics shall include automatic gain control (AGC) to produce a satisfactory image at night for the VDS algorithms.

The imager luminance signal to noise ratio (S/N) shall be more than 50 dB with the automatic gain control (AGC) disabled.

The imager shall employ three dimensional dynamic noise reduction (3D-DNR) to remove unwanted image noise.

The camera imager shall employ wide dynamic range (WDR) technology to compensate for wide dynamic outdoor lighting conditions. The dynamic range shall be greater than 100 dB.

The camera shall be digital signal processor (DSP) based and shall use a CCD sensing element and shall output color video with resolution of not less than 540 TV lines. The color CCD imager shall have a minimum effective area of 811(h) x 508(v) pixels.

The camera shall include an electronic shutter control based upon average scene luminance and shall be equipped with an auto-iris lens that operates in tandem with the electronic shutter. The electronic shutter shall operate between the range of 1/60th to 1/90,000th second.

The camera shall utilize automatic white balance.

The camera shall include a variable focal length lens with variable focus that can be adjusted, without opening up the camera housing, to suit the site geometry by means of a portable interface device designed for that purpose and manufactured by the detection system supplier.

The horizontal field of view shall be adjustable from 4.5 to 48 degrees. This camera configuration may be used for the majority of detection approaches in order to minimize the setup time and spares required by the user. The lens shall be a 12x zoom lens with a focal length of 3.5mm to 35mm.

The lens shall also have an auto-focus feature with a manual override to facilitate ease of setup.

The camera shall incorporate the use of preset positioning that store zoom and focus positioning information. The camera shall have the capability to recall the previously stored preset upon application of power.

The camera shall be housed in a weather-tight sealed enclosure. The housing shall allow the camera to be rotated to allow proper alignment between the camera and the traveled road surface.

The camera enclosure shall be equipped with a sunshield. The sunshield shall include a provision for water diversion to prevent water from flowing in the camera's field of view. The camera enclosure with sunshield shall be less than 3.5" (89mm) diameter, less than 5.25" (133mm) long, and shall weigh less than 2.5 pounds (1.14kg) when the camera and lens are mounted inside the enclosure.

The enclosure shall be designed so that the pan, tilt and rotation of the camera assembly can be accomplished independently without affecting the other settings.

The camera enclosure shall include a proportionally controlled Indium Tin Oxide (ITO) lens coating for the heating element of the front glass that maximizes heat transfer to the lens. The output power of the heater shall vary with temperature, to assure proper operation of the lens functions at low temperatures and prevent moisture condensation on the optical faceplate of the enclosure. The transparent coating shall not impact the visual acuity and shall be optically clear.

The glass face on the front of the enclosure shall have an anti-reflective coating to minimize light and image reflections.

The glass face on the front of the enclosure will include a Titanium Dioxide self cleaning coating

When mounted outdoors in the enclosure, the camera shall operate satisfactorily in a temperature range from -30° F to +140° F (-34 °C to +60 °C) and a humidity range from 0% RH to 100% RH. Measurement of satisfactory video shall be based upon VDP system operation.

The camera shall be powered by 48VDC. Power consumption shall be 5 watts typical and 16 watts or less under worst conditions.

Recommended camera placement height shall be 33 feet (or 10 meters) above the roadway, and over the traveled way on which vehicles are to be detected. For optimum detection the camera should be centered above the traveled roadway. The camera shall view approaching vehicles at a distance not to exceed 350 feet (107 meters) for reliable detection (height to distance ratio of 10:100). Camera placement and field of view (FOV) shall be unobstructed and as noted in the installation documentation provided by the supplier.

The video signal shall be fully isolated from the camera enclosure.

Cable terminations at the camera for video and power shall not require crimping tools.

A weather-proof protective cover shall be provided shall be provided to protect all terminations at the camera. No special tooling shall be required to remove or install the protective cap.

The camera assembly shall include a temperature sensor. The sensor will be polled by the VDS every minute and will supply the current air temperature. The VDS software will display this information on the On-Screen Display for each camera.

#### 5. Functional Capabilities

Detection zones shall be programmed via an embedded application displayed on a video monitor and a keyboard and a pointing device connected to the CCU. The menu shall facilitate placement of detection zones and setting of zone parameters or to configure system parameters. A separate computer shall not be required for programming detection zones or to view system operation. All programming function shall occur on live video images, no snapshots or still images are allowed.

The VDS software shall store up to five completely independent detection zone patterns in non-volatile memory. The VDS can switch to any one of the three different detection patterns within 1 second of user request via menu selection with the pointing device. Each configuration shall be uniquely labeled and able to be edited by the user for identification. The currently active configuration indicator shall be displayed on the monitor.

The VDS shall detect vehicles and bicycles in real time as they travel across each detection zone.

The VDP shall automatically define a pedestrian crossing area, and track pedestrians in real-time as they travel across this pedestrian crossing area in both directions. The VDP shall count pedestrians moving left-to-right, and right-to-left. The VDP shall measure the speed of pedestrians moving left-to-right, and right-to-left, and provide the minimum, maximum, and average speed of the pedestrians per the bin interval. These values shall be displayed on-screen for both directions, and an option shall be provided to the user to turn this on-screen display on or off. This data will be stored in local memory for later retrieval via a remote device. The data will be stored at the Bin Interval set in the system.

The VDS shall accept new detection patterns from an external computer through the Ethernet port when the external computer uses the correct communications protocol for downloading detection patterns. A Windows™-based software designed for local or remote connection and providing video capture, real-time detection indication and detection zone modification capability shall be provided with the system.

The VDS shall have the capability to automatically switch to any one of the stored configurations based on the time of day which shall be programmable by the user.



The VDS shall send its detection patterns to an external computer through the Ethernet port when requested when the external computer uses the appropriate communications protocol for uploading detection patterns.

The VDS shall default to a safe condition, such as a constant call on each active detection channel, in the event of unacceptable interference or loss of the video signal.

The VDS shall be capable of automatically detecting a low-visibility condition such as fog and respond by placing all affected detection zones in a constant call mode. A user-selected alarm output shall be active during the low-visibility condition that can be used to modify the controller operation if connected to the appropriate controller input modifier(s). The system shall automatically revert to normal detection mode when the low-visibility condition no longer exists. An On-Screen Icon will be displayed while the system is in this mode.

Up to 32 detection zones per camera input shall be supported and each detection zone must be user-sizeable to suit the site and the desired vehicle detection region.

The VDS shall provide up to 32 open collector output channels per camera input using one or more extension modules.

A single detection zone shall be able to replace multiple inductive loops and the detection zones shall be OR'ed as the default or may instead be AND'ed together to indicate vehicle presence on a single approach of traffic movement.

When a vehicle is detected within a detection zone, a visual indication of the detection shall activate on the video overlay display to confirm the detection of the vehicle for the zone.

Detection shall be at least 98% accurate in good weather conditions, with slight degradation possible under adverse weather conditions (e.g. rain, snow, or fog) which reduce visibility. Detection accuracy is dependent upon site geometry, camera placement, camera quality and detection zone location, and these accuracy levels do not include allowances for occlusion or poor video due to camera location or quality.

The VDS shall provide dynamic zone reconfiguration (DZR). DZR sustains normal operation of existing detection zones when one zone is being added or modified during the setup process. The new zone configuration shall not go into effect until the configuration is saved by the operator.

Detection zone setup shall not require site specific information such as latitude and longitude to be entered into the system.

The VDS shall process the video input from each camera at 30 frames per second. Multiple camera processors shall process all video inputs simultaneously.

The VDS shall output a constant call during the background learning period of no longer than 3 minutes.

Detection zone outputs shall be individually configurable to allow the selection of presence, pulse, extend, and delay outputs. Timing parameters of pulse, extend, and delay outputs shall be user definable between 0.1 to 25.0 seconds.

Up to six detection zones per camera view shall have the capability to count the number of vehicles detected. The count value shall be internally stored for later retrieval through the Ethernet port. The zone shall also have the capability to calculate and store average speed and lane occupancy at user-selectable bin intervals of 10 seconds, 20 seconds, 1 minute, 5 minutes, 15 minutes, 30 minutes and 60 minutes.

In addition to the count type zone, the VDS shall be able to calculate average speed and lane occupancy for all of the zones independently. These values shall be stored in non-volatile memory for later retrieval.

The VDS shall have an “advance” zone type where raw detection output duration to the traffic controller is compensated for angular occlusion and distance.

The VDS shall employ color overlays on the video output.

The VDS shall have the ability to show controller phase status (green, yellow, or red) for up to 8 phases. These indications shall also be color coded.

The user shall have the ability to enable or disable the display of the phase information on the video output.

The VDS shall have the capability to change the characteristics of a detection zone based on external inputs such as signal phase. Each detection zone shall be able to switch from one zone type (i.e. presence, extension, pulse, etc.) to another zone type based on the signal state. For example, a zone may be a “count” zone when the phase is green but change to a “presence” zone type when the phase is not green. Another application would be zone type of “extension” when the signal phase is green and then “delay” when red.

The VDS software shall aid the user in drawing additional detection zones by automatically drawing and placing zones at appropriate locations with only a single click of the mouse. The additional zone shall utilize geometric extrapolation of the parent zone when creating the child zone. The process shall also automatically accommodate lane marking angles and zone overlaps.

When the user wishes to modify the location of a zone, the VDS software shall allow the user move a single zone, multiple zones or all zones simultaneously.

When the user wishes to modify the geometric shape of the zone, the VDS software shall allow the user to change the shape by moving the zone corner or zone sides.

On screen zone identifiers shall be modifiable by the user. The user shall be allowed to select channel output assignments, zone type, input status, zone labels or zone numbers to be the identifier.

The VDS software shall support bicycle type zones where the zone can differentiate between motorized vehicles and bicycles, producing a call for one but not the other.

Bicycle zone types shall only output when a bicycle is detected. Larger motorized vehicles such as cars and trucks that traverse a bicycle zone shall not provide an output.

The VDS software shall provide the ability to assign a separate output channel for bicycle zones to allow traffic controllers to implement special bicycle timing.

Placement of bicycle type zones in vehicle lanes shall be allowed.

Upon detection of a bicycle, the video output overlay shall indicate active detection as well as providing a unique bicycle detection identifier to visually distinguish bicycle detection versus vehicle detection.

Up to six bicycle detection zones per camera view shall have the capability to count the number of bicycles detected in addition to their normal detection function. The count value shall be internally stored for later retrieval through the Ethernet port.

The On-Screen Display shall include an Automatic Traffic Volume graph. This graph will display estimated Vehicles Per Hour (VPH) per movement for each camera view. The graph will display a rolling 24 hour period of VPH.

The On-Screen Display shall include an Occupancy Graph. This graph will display estimated approach occupancy for each camera view. The graph will display a rolling 24 hour period of Occupancy.

This section sets forth the minimum requirements for the VDS to provide a single point interface to remote and local users. The VDS shall also have the capability to stream up to four simultaneous video streams over an Ethernet interface.

The user interface shall provide capabilities to enable multiple rack-mounted video detection processors to be locally and remotely accessed from a single point via an Ethernet connection.

The device shall allow the operator to view four videos simultaneously or any one video by controls embedded in the VDS.

Local user access to video detection programming shall be limited to the detection processor unit that is currently being displayed on the monitor.

All local programming and setup parameters for the video detection processor shall be user accessible through the interface unit without requiring the user to swap user interface cables between video detection processors.

Remote access to the device shall be through the built-in Ethernet port via access software running on a Microsoft Windows based personal computer.

A Windows OS remote access firmware shall also be available for remote setup and diagnostics of the interface unit.

The VDS shall support streaming video technology using H.264 standards to allow the user to monitor video detection imagery over the Ethernet interface. Motion JPEG streaming video shall not be allowed.

The interface unit shall allow eight independent streams, one from each video processor, to be transported via Ethernet to four independent streaming video players simultaneously in D1 resolution.

The interface shall allow the user to select the resolution of the displayed streamed video.

The interface unit shall support the streaming and display of eight concurrent streams in D1 resolution.

The VDS shall allow the user to manage the unit's Ethernet bandwidth usage by allowing the user to select high, medium or low resolution.

The interface shall allow the user to change the unit's Ethernet network settings of IP address, subnet mask and default gateway.

The VDS shall allow the user to upload new application firmware through the use of the interface, remotely or on-site.

A Windows OS based application will be provided to remotely view video streams from the VDS.

An iOS and Android based application shall be available to remotely access each configured VDS on the agency's network. This application shall allow the user to choose between any number of pre-configured intersection locations. Using the iOS or Android device, the application will allow the user to view live video from any camera at that intersection, including vehicle and bicycle detections in real-time. The application will also allow the user to view individual intersection data, including turning movement counts and occupancy. The application will show each data set in time periods of day, week, or month, and have the capability of turning on or off right, left, and thru movement data for turning movement count data. The application will also allow the user to view current system diagnostic data, including the following, but not limited to; individual camera glare and low contrast information, system

low contrast, constant call, alarm, reboots, logins, and menu access information.

#### 6. SDLC Functionality

This section sets forth the minimum requirements for a full-function BIU and integrated video detection communication. The VDS shall provide outputs to the controller of vehicle calls from video processors that reside within the detector rack.

The VDS shall have the capability of monitoring phase information and passing that information and other system data such as “time” from the controller to video detection processor modules. The VDP shall also accept data from video processor modules and relay the information to the controller. The unit shall provide a maximum of 64 detector outputs to the controller via the SDLC interface.

The module shall be in compliance with the following industry specifications:

- Transportation Electrical Equipment Specifications (TEES), August 16, 2002 (or latest edition), California Department of Transportation
- NEMA Standard Publication TS 1-1989 (or latest edition), Traffic Control Systems, National Electrical Manufacturers Association
- NEMA Standard Publication TS 2-2003, Traffic Controller Assemblies With NTCIP Requirements, Version 02.06 (or latest edition), National Electrical Manufacturers Association

The VDS shall have two data interfaces:

- The interface to the controller shall be accomplished by the use of the TS-2 SDLC port and protocol in accordance with the TS-2 specifications. The module shall be able to be configured to respond to BIU addresses 8, 9, 10 and 11 or a combination thereof.
- The interface to communicate with card rack video detection processors shall be manufacturer specific.

One LED indicator shall be provided for the TS-2 SDLC interface. The indicator shall be used to inform the user of any communication activity on the SDLC port.

#### 7. Installation

The cable to be used between the camera and the CCU in the traffic cabinet shall be Cat-5e, shielded, direct burial. This cable shall be suitable for installation in conduit or overhead with appropriate span wire. Shielded RJ-45 connectors shall be used where applicable. The Cat-5e cable, RJ-45 connector, stripping and crimping tool shall be approved by the supplier of the video detection system, and the manufacturer's instructions must be followed to ensure proper connection.

The Contractor shall install the cameras on traffic signal mast arms or luminaire mast arms at the location directed by the Engineer; in accordance with the manufacturer's guidelines; and to the satisfaction of the Engineer. If, in the opinion of the Engineer, it is necessary to install extension brackets on the mast arm mounted cameras to obtain satisfactory operation the Contractor shall provide and install them as part of the intersection detection. The cameras shall be aimed and secured in an aimed position by the Contractor. The Contractor shall employ a Video Monitor and lens adjustment module approved by the manufacturer. The cameras shall be aimed so that the field of view is as directed by the Engineer. Drip loops shall be provided for the camera power and video cables.

The video detection system shall be installed by supplier factory certified installers and as recommended by the supplier and documented in installation materials provided by the supplier. Proof of factory certification shall be provided.

#### 8. Limited Warranty

The supplier shall provide a limited five-year warranty on the video detection system.

During the warranty period, technical support shall be available without charge from the supplier via telephone within 4 hours of the time a call is made by a user, and this support shall be available from factory-certified personnel or factory-certified installers.

Updates to VDP software shall be available from the supplier without charge for the life of the product.

#### 9. Maintenance and Support

The supplier shall maintain an adequate inventory of parts to support maintenance and repair of the video detection system. These parts shall be available for delivery within 30 days of order placement.

The supplier shall maintain an ongoing program of technical support for the video detection system. This technical support shall be available via telephone, or via personnel sent to the installation site upon placement of an acceptable order.

Installation and training support shall be provided by a factory authorized representative without charge.

All product documentation shall be written in the English language.

#### 10. Deliverables

One video camera shall be provided for each signalized intersection approach to be equipped with detection as shown in the plans. One two-input video detection processor (VDP) module shall be provided for each two video cameras. One Central Control Unit (CCU) shall be provided per intersection. One extension module (EM) and one Ethernet communication module shall be provided per intersection. One color video monitor and wireless pointing device shall be provided per intersection. A Windows™-based software package designed for local or remote connection and providing video capture, real-time detection indication and detection zone modification capability shall also be provided with the system.

The color monitor shall be a 10.1" CCTV TFT LCD High Resolution (1024 X 768) or City of Minneapolis approved equal.

Upon proper orientation and connection of the various video detection cameras by the contractor, the factory authorized representative shall assist and train City of Minneapolis personnel in utilizing all software, setting up detection zones and channel assignments as well as establishing the other necessary parameters for a properly performing detection system.

One new spare two-input video detection processor (VDP) module, one Ethernet communication module, and one new spare video camera shall be provided to the City of Minneapolis for maintenance purposes upon acceptance of the system.

Each video detection system shall be complete and in operation. The cost of furnishing all materials and labor to perform the work described above at each identified intersection shall be paid for as **“Video Detection System Type 2 Intersection (n)”, Each.**



I. Video Detection System Type 3

Video Detection Systems 3 and 4 no longer an option.

K. Handholes

Rings and covers shall be set in a bed of mortar and leveled to the finished surrounding grade. Cast-iron ring and covers constructed in accordance with City of Minneapolis Standard Plate No. TRAF-1715-R5 shall be furnished and installed by the Contractor. Handhole shall be constructed in accordance with Minneapolis Standard Plate No. TRAF-1710-R3. A drain field shall be provided with each handhole.

New metal handhole rings and covers shall be electrically grounded. No existing handhole ring and cover shall be reused. Rings and covers for new handholes shall be prepared for grounding prior to installation. Grounding shall be accomplished by attaching a 24-inch-long #6 braided ground cable between the underside of the handhole ring and the underside of the handhole cover. Handhole ring shall be connected by means of No. 8 electric grounding conductor to nearest grounded street light or traffic signal structure. Conduits shall be installed by the use of a hole saw to cut through the handhole wall. The area surrounding the conduit entrance shall be sealed with a mortar filling. Conduits shall extend a minimum of 1 inch and not more than 2 inches into the handhole.

**Signal interconnect conduit runs passing through handholes shall have both entering conduits placed in direct horizontal alignment.**

No splicing shall be allowed in handholes unless specified in these specifications or on the plans.

The Contractor shall remove to the bottom of the handhole, any excess material inside of the handhole.

The Contractor shall salvage in place handholes not reused as part of a revised permanent signal system unless otherwise directed by the Engineer.

Salvaged and reused metal rings and covers shall be painted before reuse. Metal rings and covers shall be pretreated prior to concrete placement such that the concrete does not adhere to exposed surfaces. Rings and covers shall be cleaned free of adhering concrete after placement. Painting of the metal rings and covers is no longer required.

High density polymer concrete rings and covers shall be removed if exposed or otherwise disturbed by the project and replaced with steel handhole cover and rings.

L. Remove Existing Handhole

The Contractor shall remove the existing handhole while leaving the existing cables and the conduits intact. Typically, the Plans shall have directed the Contractor to install another structure in its place.

Removal procedure may take one of two forms. Method one: The contractor may excavate around existing conduits around handhole, leaving existing cables in operation inside handhole. Contractor may break handhole body, leaving conduits and internal cables intact. Method two: Contractor may remove existing cables from the handhole. This may require removal of cables from multiple directions and may require turning off power to some traffic signals. If existing detector loops are disconnected at the splice, the contractor shall remake the splice in accordance with the splice procedure listed elsewhere in these special provisions.

In all cases, the contractor must preserve the integrity of the conduit system and of the existing electrical cables meeting at the removed handhole unless otherwise directed in the Plans.

#### Adjusting Existing Handholes:

Any existing handhole that is impacted by construction (concrete removal or height adjustment) must have a new grounded metal ring and cover installed.

#### M. Installation of Mast Arm Poles

The Contractor shall mount all transformer bases directly on the foundation. The use of the lower anchor rod nuts for leveling is not permitted. The lower anchor rod nut shall be tightened snug against the upper plate of the transformer base after leveling. Any pole that is not plumb shall be correctable up to 1/2-inch using stainless steel washers. The Contractor, at the Contractor's expense, shall recap foundations that are incorrectly installed.

#### N. Signal Out Requirements

During the period when each existing or temporary signal system is de-energized, traffic signs will be required to inform motorists that the signal indications are not operating. The Contractor shall furnish, erect, and maintain "Stop Ahead" and "Stop" signs and barricades. The quantity and size of the temporary signs and barricades as well as their placement in the field shall be as directed by the Engineer. The Contractor shall furnish and install materials to keep these signs upright and stationary. The signs, barricades, etc., shall remain the property of the Contractor. The Contractor shall notify the Engineer five (5) days in advance of de-energizing the system. The Engineer shall approve the day and time and duration of these events.

#### O. Vehicle And Pedestrian Signal Face Installation

1. Pedestal Mounted: The provisions of MnDOT 2565.3L1 are modified to include the following:

Vehicle and pedestrian signal faces required to be mounted at the top of traffic signal pedestals shall be mounted in accordance with the “Minneapolis Standard Plate No. Traf- 1340-R2 shown in the Plans.

2. Vertical Pole Shaft Mounted: The provisions of MnDOT 2565.3L2 are modified to assure that vehicle and pedestrian signal faces required to be mounted on a vertical pole shaft of a mast arm pole standard shall be mounted in accordance with the Minneapolis Standard Plate No. Traf-1330-R3 shown in the Plans.

The pedestrian indications Type 30A(R) and Type 30A(L) shall have no lower bracket and banding as shown.

The one-way pole mounted vehicle indications Type 10A and Type 10B shall have the upper mounting bracket attached to the vertical pole shaft by the use of knurled steel threaded inserts and not by banding.

The two-way pole mounted vehicle indications Type 20A shall have the upper mounting bracket attached to the vertical pole shaft by the use of knurled steel threaded inserts and not by banding.

3. Pedestrian Signal Attachment: Pedestrian signals shall be attached to the signal assembly plumbing using 1 ½” X 2” galvanized steel nipples to connect the signal to the 90-degree elbow at the top of the pedestrian signal. The pedestrian signal assembly shall be held in place on the 1 ½” plumbing through the use of a 2” – 10 gauge plated steel bushing and a 1 ½” by ½” galvanized steel lock nut.
4. In-place Signal Heads: All previous in-place heads shall be replaced new on the project and bid as such.

P. Maintenance of Existing Electrical Systems\

Maintain and keep in operation existing electrical systems (signals, street lighting, and interconnect) in accordance with MnDOT 2565.3B and as follows:

Except during any periods of authorized work suspension, the Contractor is responsible for locating all underground facilities of existing traffic signal, street lighting, and interconnect systems including temporary and newly constructed systems within the limits of the construction project, for the duration of the construction project in accordance with the applicable provisions of MnDOT 1514 and in accordance with Minnesota State Statute 216D.

The responsibility for locating underground electrical system facilities shall be transferred to the Contractor on the project start date as shown on the proposal.

The City of Minneapolis locating group will provide an initial locate of the underground electrical system facilities within the project limits at the request of

the Contractor at the start of the project. The request for the initial locate must be submitted to the City of Minneapolis a minimum of four (4) working days prior to the project start date.

Locate requests that are within the construction project limits will continue to be received by the City. These locate tickets will be forwarded to the Contractor's representative responsible for coordinating locate requests within the projects limits. The locate tickets will be forwarded via e mail or fax. Confirmation of receipt of the locate ticket must be sent by the Contractors representative back to the City within two (2) hours of the City's sending the Contractor's representative the locate request.

The Contractor responsible for locating all underground electrical system facilities will repair any damage as the result of improperly located or unmarked underground electrical system facilities within the project limits.

The repair of the damaged underground electrical system facilities must be in accordance with MnDOT 2545.3A, 2565.3B and in accordance with RTMC design and construction requirements all to the satisfaction of the Engineer. This work is considered incidental.

It is the Contractor's responsibility to notify the City to provide contact information and establish the Contractor has assumed responsibility for locating the City's underground electrical system facilities within the project limits. The form below shall be filled out by the Contractor's representative at the pre-construction meeting and the completed form shall be turned over to the City at the pre-construction meeting.

Until final written acceptance of the project by the Engineer (MnDOT 1716) this work is considered incidental.

During any periods of authorized work suspension, the City will provide and maintain all items of the existing, temporary, and newly constructed electrical systems.

In the event of an authorized work suspension the Contractor must supply 3 copies of an up to date accurate As Built drawing of the existing, temporary and newly constructed electrical systems to the Engineer prior to the work suspension.

**PROVIDE TO THE CITY OF MINNEAPOLIS CONTACT INFORMATION WITH NAMES AND TELEPHONE NUMBERS FOR 24 HOURS A DAY, 7 DAYS A WEEK MAINTENANCE AS DEFINED BELOW.**

Locating Responsibility Form

Job S.P. Number \_\_\_\_\_

Job Type \_\_\_\_\_

Start Date \_\_\_\_\_

End Date \_\_\_\_\_

Location \_\_\_\_\_

Lighting/ Signal Inspector \_\_\_\_\_

Contractor \_\_\_\_\_

Contractor (24 Hour Contact) \_\_\_\_\_

Project Manager \_\_\_\_\_

Phone Number \_\_\_\_\_

Fax Number \_\_\_\_\_

Email \_\_\_\_\_

Electrician \_\_\_\_\_

Phone Number \_\_\_\_\_

Locator Area \_\_\_\_\_

Project Engineer \_\_\_\_\_

Phone Number \_\_\_\_\_

Chief Inspector \_\_\_\_\_

Phone Number \_\_\_\_\_

Weekly Meeting \_\_\_\_\_

Q. Placing Traffic Control Signals In Operation

All vehicle signal faces and pedestrian indications shall be bagged or turned away from traffic immediately after erection to clearly indicate that the signal is not in operation. All bagging shall be gunnysacks or other like material approved by the Engineer and shall be maintained by the Contractor to the satisfaction of the Engineer. Bagging shall be of a grey or light brown color so as to clearly indicate that the signal face is not in use. Orange, red, or black bagging will not be permitted.

When the signal system is to be placed in operation, all vehicle signal faces and pedestrian indications shall be unbagged and aimed as directed by the Engineer.

At the time of controller cabinet connection by the City and at turn on, the Contractor shall have on hand and available at the location: spare lamps of each size, workers and equipment to reach overhead indications, and shall perform such work as may be required to correct such incidents as may be revealed in the connection and/or energization process. Only the City shall place the signal system in operation.

R. Accessible Push Button Units

Install accessible pedestrian push button units at the locations as indicated in the Plans. Each push button unit contains three (3) custom components:

1. Sign with Braille, City requires the 5" x 7" size option.
2. Push button with direction arrow
3. Custom voice message

The Contractor shall provide digital files containing the custom voice messages to Minneapolis Traffic staff.

Pay careful attention to button placement to ensure the button is placed in the correct location. Mount the button facing the pedestrian landing.

Follow the manufacturer's installation requirements.

Apply an approved electrical insulating coating to the APS wire termination blocks, after wire installation. Electrical insulating coatings shall comply with the following MnDOT approved specifications:

Terminal blocks, screws, and spade lugs shall be covered with an electrical insulating coating that meets the following specifications:

E. Shall be an electrical grade insulator with a minimum dielectric strength of 850 V/mil when coating is fully dried.

1. Shall be an aerosol spray type coating.
2. Shall dry to a tack free handling condition within 2 hours of application at 70 degrees F.
3. Shall be red in color.
4. Shall protect all sprayed surfaces against moisture, corrosion, oil, alkalies, and acids.
5. Shall not degrade the electrical characteristics of the devices after the spray is applied and has fully dried.

Apply a bead of 100% clear silicone sealant around the top of the push button station housing where the button comes in contact with the pole shaft.

S. Control Cable Installation

At each system, before cabinet installation by the City, the Contractor for this Contract shall terminate all new electrical cables and conductors extending above the cabinet concrete foundation as follows:

Cables:

- Shall be cut 6.5 to 10 feet above the cabinet concrete foundations, and
- Shall have the ends taped, and
- Shall be labeled with the cable number as per the field wiring diagram - (label shall be applied 12 inches above the cabinet concrete foundation), and
- Shall be coiled, tie wrapped, and left in a neat manner.

T. Completed Intersection Installation Testing

After successful installation of all items required in the Plans and Special Provisions, the City shall inspect and test each intersection prior to acceptance of the completed installation.

Each completed intersection installation shall function to the satisfaction of the Engineer and in accordance with the intent of the Plans and Special Provisions.

U. Traffic Signal Cabinet

The cabinets will be furnished and installed by the City. The contractor must notify the city at least 2 months prior to the estimated install date.

1. Controller Timing: Signal timing settings for controller units will be furnished and installed by the City.
2. EVP & Video Detection Equipment: The Contractor shall provide cabinet located EVP electronics and any necessary additional harnessing and all cabinet located Video Detection hardware to the Engineer for delivery to the City of Minneapolis. City forces will test, and then install and connect the equipment in the traffic signal cabinet.

V. Installation and Connection of Permanent Cabinet & Control Equipment

At each system, the City of Minneapolis will furnish, install and connect the traffic signal cabinet, complete with controller unit and all required signal control equipment, including Contractor supplied components. Contractor forces shall be on site to assist the City during the installation process to trouble shoot issues identified during the cabinet installation/connection process.



W. Operation of Traffic Signals

1. Temporary Traffic Signal Systems: The Contractor shall not interfere with the operation of the traffic control signal system at any time at any intersection, except as may be otherwise authorized by the Engineer.

The City will utilize temporary signals to provide temporary operation at each intersection where temporary signal operation is required.

The Contractor shall remove and salvage all items of the existing traffic control signal systems not used in the temporary signal operation.

2. Continuous Operation: The Contractor shall ensure that a traffic control signal system is in operation at all times at those intersections where he is or has worked, except as may be otherwise directed by the Engineer.

3. Traffic Control Interconnect: The City requires that an operational traffic signal interconnect system be maintained through the project area until such time as the in place traffic signal systems are turned off. If the traffic signal interconnect system is utilized to communicate with other intersections outside of the project area a temporary interconnect system may have been installed and will need to remain in place and intact until such time as its functionality is can be replaced by a newly installed system. The Contractor shall not make any changes to or remove any part of the permanent or temporary interconnect system without first contacting and receiving the approval of the Minneapolis Traffic Division.

If temporary interconnect facilities are shown in the Plans, the City will furnish and install all materials, equipment and labor required to maintain an operating temporary interconnect system for all signals within the project limits as well as any systems whose interconnect functions are carried on cables passing within or through the project limits.

## X. Painting

The Contractor shall furnish all paint required after verification of the exact paints and colors with the City of Minneapolis Traffic and Parking Services.

At each system, all painting shall be in accordance with the provisions of MnDOT 2565.3X, except that finish coat paint for all traffic signal system items shall be two (2) manufacturers shop coats as modified below.

Traffic signal pedestal bases and push button station bases, shall be finish painted with Exterior Enamel, Signal Green, conforming to the City of Minneapolis Specifications.

Traffic signal pedestal shafts, pedestal slipfitter collars, all signal brackets, pipe fittings, push button stations and pipe caps shall be finish painted with Exterior Enamel, Minneapolis Signal Yellow conforming to Minneapolis Specifications. (Sherwin Williams industrial enamel oil base gloss yellow code # B54Y37)

A shop coat of primer paint shall be applied to the outside surface of all poles, bases, and shafts.

Mast arm pole vertical shafts, traffic signal mast arms, auxiliary sign arms, APS extender pipe, luminaire pole shaft extensions, luminaire mast arms, mast arm pole transformer bases as well as street light pole transformer bases and street light poles which have signal heads attached thereto shall be finish painted with Exterior Enamel Thermoset Acrylic conforming to the following color requirement and specifications of the City of Minneapolis:

- Paint color shall be Minneapolis UPS Brown.

The fitter on the top of the luminaire extension that transitions from the extension to the luminaire fixture shall be UPS Brown.

Dull Non-Reflective Black enamel shall be used on visors, directional louvers and background shields.

## Y. As-Built Drawings

As-built drawings are required for all construction projects. See the "Record Drawing Requirements" section of Division S (S-40) for more information.

## SS-1.4 Removing, Salvaging, and Stockpiling Existing Materials and Electrical Equipment

This work shall consist of the removal of all or portions of existing traffic signal control systems.

### A. Removing and Salvaging Existing Systems

When directed by the Engineer, the Contractor shall remove and salvage for the City all items of the existing traffic control signal systems, signal equipment, interconnect cable, foundations, handholes, service equipment, and signs in accordance with the applicable provisions of MnDOT 2104; with the applicable provisions of MnDOT 2565.3Y; and the following:

1. Underground conduit and handholes shall be removed, unless otherwise directed by the Engineer.
2. Salvaged items shall be disassembled as directed by the Engineer and shall be delivered to the City of Minneapolis Traffic and Parking Services Division at 300 Border Avenue North, Minneapolis.

The Contractor shall contact the City Traffic and Parking Services office at least three working days in advance of delivery as follows:

Traffic Electrical General foreman Telephone: 612-673-5759

Before returning salvaged items to City of Minneapolis, contractor shall meet on site with Traffic Electrical General Foreman (612-673-5759) to determine what to salvage or scrap.

Any damage to the salvaged materials resulting from the salvage operation shall be repaired and replaced at the Contractor's expense.

3. Salvaged items shall be disassembled before being delivered to the City of Minneapolis as follows:
  - a. Vehicle signals and pedestrian signals shall be removed and left intact.
  - b. Remove background shields from vehicle signal faces without damaging shields or signal faces.
  - c. Remove and disassemble all signal bracketing and pipe fittings without damaging signal bracketing and signal faces.
  - d. All signal and communication cables and conductors salvaged shall be neatly coiled and tagged with correct footage.

SS-1.4      **Removing, Salvaging, and Stockpiling Existing Materials and  
Electrical Equipment**

- e. Mast arm pole standards shall be disassembled by unbolting and removing mast arms, overhead signal head mounts, and signal brackets. All nuts and bolts shall be packaged and tagged.
  - f. Luminaires shall be removed from the luminaire mast arms.
  - g. Pedestal shafts and shaft rods shall be removed from pedestal bases. Pedestal slipfitter collars shall be removed and all set screws and plugs left intact.
  - h. Service equipment, conduit risers, power conductors, etc., shall be removed from service wood poles and conduits disconnected from enclosures.
  - i. Signs and sign brackets shall be removed from signal poles and mast arms.
  - j. All other salvable items shall be removed and disassembled as directed by the Engineer. All non-City owned equipment shall be coordinated with owner to be removed and reinstalled (wifi, small cell, video cameras).
  - k. Existing handhole rings and covers that are not to be reused shall be salvaged and delivered to the City.
  - l. **Where controller equipment is being replaced, the existing traffic signal cabinet electronics will be removed and salvaged by the City.**
  - m. Traffic signal cabinets shall be disconnected from all field cabling before removal. Damage to terminal facilities resulting from the removal/transportation process shall be billed to the Contractor.
4. Concrete cabinet and pole foundations, conduit, and items deemed non-salvageable by the Engineer of each existing traffic control signal system shall be removed and disposed of outside the right-of-way in any manner that the Contractor may elect subject to the provisions of MnDOT 2104.3C3 and as noted elsewhere in these Special Provisions.

5.     The concrete cabinet and pole foundations, and the underground signal conduits may include asbestos containing electrical conduits (Transite). The 3' x 18" vertical pipe in handholes may also contain asbestos, Transite pipe. Underground signal conduits that contain asbestos will have been encased in concrete at the time of installation. For the procedure for handling and disposal of these asbestos-containing materials see the Asbestos Abatement located in Appendix A. Contact the City of Minneapolis to have the City be on site during the Contractor removal of these asbestos-containing materials, so that the City may observe the Contractor removal procedures.

Contractor or subcontractor conducting the Transite material removal and transport work must be a firm licensed to conduct asbestos abatement. **Report manifests for those materials with Transite removal must be submitted to the City by the Contractor.** Removal materials will not be allowed to be transported to City-owned facilities.

6.     The removal of underground signal conduits, traffic signal handholes, and foundations containing asbestos shall be paid for as part of the lump sum cost for Salvage Signal System. Refer to Appendix A for information regarding this removal.
7.     All removal, disposal, and salvaging of materials of the existing traffic control signal systems, as required by the Plans and Special Provisions shall be paid for in accordance with the "Method of Measurement and Payment" included in a separate section.

**SS-1.5 Type C and D Signs**

This work shall consist of furnishing and installing Type C and Type D sign panels, and installing City furnished signs as directed by the Engineer, in accordance with the applicable provisions of MnDOT 2564; with the details shown in the Plans; and as follows:

**A. General**

The Contractor shall furnish and install Type C and Type D sign panels on traffic signal mast arms, pedestal shafts, or mast arm pole shafts as indicated in the Plans.

Each Type C sign shall be in accordance with the Standard Sign Drawings of the MnDOT Standard Signs Manual and with the applicable provisions of MnDOT 3352.

**B. Materials**

Sign base, sign face and sign legend material for sign panels Type C and Type D shall be in accordance with the applicable provisions of MnDOT 2564, except the sign face and legend material shall be as follows:

Sign face material for sign panels shall be Direct Applied Wide Angle Prismatic Retroreflective Sheeting for Visual Impact Performance (VIP) manufactured by 3M Company.

Sign legend material for sign panels shall be Direct Applied Wide Angle Prismatic Retroreflective Sheeting for Visual Impact Performance (VIP) manufactured by 3M Company, except where black legend is specified the sign legend material shall be in accordance with MnDOT 3352.2A5c or MnDOT 3352.2A5d.

**C. Fabrication**

Type D sign panel layouts are dimensioned as follows:

**1. Vertical Dimensioning**

The dimension given is for the legend component having the largest vertical dimension in the particular line of copy. Other legend components are centered on the larger legend component unless indicated otherwise.

## 2. Horizontal Dimensioning

The horizontal dimensions given within the sign panel are to the tenth of an inch and are cumulative representing the distance from the left edge of panel to the extreme left edge of the legend component.

## 3. Sign Panel Recap

The position of an arrow is measured in degrees counterclockwise from a right horizontal reference line. The abbreviation MOD used in the sign panel recap = Modified.

## D. Mounting Sign Panels

Each pedestal pole shaft or mast arm pole shaft mounted Type C sign shall be furnished with two standard sign mounting bracket assemblies (utilizing a minimum 21 mm wide stainless steel band), or at the option of the City and at the direction of the Engineer the Contractor shall drill and tap shaft, and each sign shall be mounted on each mast arm pole or pedestal pole at the location shown in the Plans.

Each Type C and mast arm mounted Type D sign panel shall be provided with mounting brackets as required and mounted at the location on the mast arm as specified in the Plans to the satisfaction of the Engineer and in accordance with the MnDOT Standard Signs Manual.

For sign panels less than 30 inches in height, the Contractor shall furnish the appropriate number of U-bolt brackets detailed on Page No. 105A of the MnDOT Standard Signs Manual (number of U-bolt brackets based on the sign panel length tabulated in the SIGN POST SPACING CHART in the Plan - **NOTE that maximum spacing between U-bolt brackets shall not exceed 45 inches**) and install U-bolt brackets at the appropriate spacing as specified in the SIGN POST SPACING CHART.

For sign panels greater than 24 inches in height, the Contractor shall furnish the appropriate number of pipe posts detailed on Page 105B of the MnDOT Standard Signs Manual (number of pipe posts based on the sign panel length tabulated in the SIGN POST SPACING CHART in the Plan - **NOTE that maximum spacing between U-bolt brackets shall net exceed 45 inches**) and install pipe posts at the appropriate spacing as specified in the SIGN POST SPACING CHART.

When attaching the U-bolts to the mast arm, the Contractor shall NOT install all U-bolts such that all “Z” brackets face the same direction as detailed in Section A-A on Page No. 105B of the MnDOT Standard Signs Manual. This will

prevent a sign panel from “walking off” the mast arm if sign bracketing loosens in the future.

The Contractor shall furnish and install a fabrication sticker (see example) in accordance with the provisions of MnDOT 2564.3H.

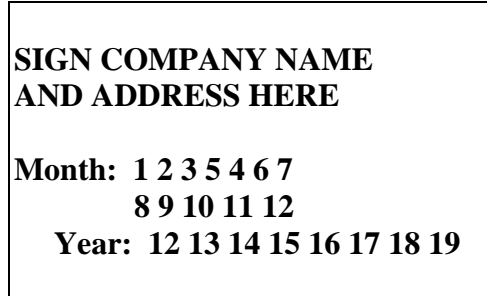

E. Measurement and Payment

Furnishing and installing Type C and Type D sign panels and installing City furnished signs, at the locations indicated in the Plans, and as specified herein shall be considered incidental work to each traffic control signal system and no direct compensation shall be made therefore.



## SS-1.6 Traffic Signal Priority Control System

This work shall consist of the installation at all the intersections, as shown in the Plans, a Priority Vehicle Detection and Control System (PVDCS). The PVDCS shall detect and identify priority vehicles such as emergency and non-emergency vehicles for preemptive or priority traffic signal service.

Commonly used abbreviations:

(PVDCS) Priority Vehicle Detection and Control System

(NEVP) Non-Emergency Vehicle Preemption, low priority

(EVP) Emergency Vehicle Preemption, high priority

Each PVDCS shall consist of a matched system of equipment that includes optical emitters, optical detectors, optical detector cables, phase selectors and confirmation light assemblies. The system shall work with the local intersection traffic signal controller to provide an effective total system operation.

Each PVDCS shall employ infrared optical communication to detect the presence of all priority vehicles and collect and record pertinent priority vehicle information.

Once operational, the PVDCS shall require no additional action from the vehicle operator to provide proper operation. The system shall provide priority operation on a first-come, first-served basis with high priority requests overriding low priority requests.

For application in Minneapolis, the PVDCS shall interface to traffic signal controllers. It shall be the Contractors responsibility to work with the City to verify proper operation of the total system.

### A. System Description

The required priority control system shall employ data-encoded infrared communication to identify the presence of designated priority or probe vehicles. The system shall be able to create a record of system users by vehicle classification and identification number. In priority vehicle mode, the data-encoded communication shall request the traffic signal controller to advance to and/or hold a desired traffic signal display selected from phases normally available. In probe vehicle mode, no traffic signal priority is requested--only a record of the probe vehicle's presence is generated.

The priority control system shall consist of a matched system of data-encoded emitters, infrared detectors, detector cable, phase selectors and system software. The emitter shall generate an infrared, data-encoded signal. The data-encoded signal shall be detected and recognized by the infrared detectors at or near the intersection over a line-of-sight path of up to 2,500 feet (762 m) under clear

atmospheric conditions. The phase selector shall process the electrical signal from the detector to ensure that the communication (1) is a valid base frequency, (2) is correctly data encoded, and (3) is within user-settable range. If these conditions are met, the phase selector shall generate a priority control request to the traffic controller (i.e., a green light) for the approaching priority vehicles, or record the presence of approaching probe vehicles by classification and identification number.

The system shall require no action from the vehicle operator other than to turn the emitter on. The system shall operate on a first-come, first-served basis. High priority requests shall override Low priority requests. The system shall interface with most traffic signal controllers and shall not compromise normal operation or existing safety provisions.

1. The Optical Signal Processor (OSP) shall be capable of categorizing vehicles in both emergency and transit signal bands. The OSP shall be capable of the following actions, configurable on a per band basis:
  - a. Local preempt – if enabled, the OSP shall place a call on the appropriate controller input in response to vehicle detection. (Default shall be enabled)
  - b. Logging – if enabled, the OSP shall be capable of writing a log record in non-volatile memory consisting of the following information: (Default shall be enabled)
    - Signal band
    - Direction
    - Call duration
    - Event start time and end time in real time

System receivers shall always give precedence to emergency band vehicles over transit band vehicles.

System receivers shall be capable of detecting emitter-equipped vehicles at a range of up to 2,500 feet (762 meters), under clear atmospheric conditions.

System receivers shall be interface with all NEMA TS-1 and TS-2 and Type 2070 traffic controllers equipped with programmable preemption routines, with no compromise to normal traffic controller functions.

Optical signal processors must be field programmable by the user, using the manufacturer's system software via computer.

## B. System Components

The required priority control, data-encoded, infrared communications system shall be comprised of five basic matched components: data-encoded emitter, infrared detector, detector cable, phase selector and system software. In addition, a card rack should be available if required. To ensure system integrity, operation and compatibility, all components shall be from the same manufacturer. The system should offer compatibility with all NEMA (National Electrical Manufacturers Association), 170, and 2070 traffic signal controllers with programmable preemption routines.

1. Emitters

A data-encoded emitter shall trigger the system. It will send the encoded infrared signals to the detector. It will be located on the priority or probe vehicle. Optical emitters shall generate the optical signal required to activate the receiver equipment in the intersection. The light pulses shall consist of a fixed base frequency emergency or transit band signal for standard preemption systems.

Optical emitters shall effect the range adjustment of the system by using activated optical emitters positioned at the desired distance while the optical signal processor range adjustment features are activated in the traffic cabinet.

2. Optical Detector

The detector shall change the infrared signal to an electrical signal. It shall be located at or near the intersection. It will send the electrical signal, via the detector cable, to the phase selector. The detector electronics shall be waterproof.

Infrared optical detectors shall sense and transform optical energy from optical emitters into electrical signals to be decoded by the optical signal processor.

Infrared optical detectors shall be capable of receiving coded signals from emitters manufactured by GTT and/or Emtrac and/or a City of Minneapolis approved equal.

Infrared optical detectors shall sense optical emitter signals over an adjustable range of 2500 feet (762m) in optimum atmospheric conditions.

Infrared optical detectors shall transmit electrical signals to the optical signal processor via up to 1000 feet of optical detector cable.

Infrared optical detectors shall have an internal terminal strip with wiring label for convenient positive connection to the detector cable.

Infrared optical detectors shall have at least a nominal conical 13-degree field of view centered about the view port normal axis.

Infrared optical detectors shall operate over a range of 12 to 30 VDC and current of up to 50ma maximum.

Infrared optical detectors shall have a ½ inch or ¾ inch FNPT mounting connection.

Infrared optical detectors shall be capable of performing a regularly occurring detector initiated diagnostic testing that checks all components used in the receipt and processing of incoming light pulses.

3. Detector Cable

The detector cable shall carry the electrical signal from the detector to the phase selector. Optical detector cable shall be in accordance with the provisions of MnDOT 3815.2C5.

4. EVP Confirmation Lights

The confirmation light assembly shall be constructed from standard electrical hardware in conformance to the arrangement and configuration requirements described herein and shown on the Plans.

The confirmation light shall be 8 watt LED PAR20 Sylvania style light or City of Minneapolis approved equal.

When the controller begins processing an EVP request, the controller shall also generate preempt confirmation outputs indicating that an EVP request is being processed (confirmation outputs shall only be generated for EVP & rail operation).

The EVP confirmation outputs shall be wire connected to unused load switches in the controller cabinet. The circuits shall be connected to EVP confirmation lights in the intersection.

The controller circuits shall be programmed to provide an illuminated solid white light to the requesting phase of EVP service and illuminated flashing white lights to all other vehicle phases.

5. Optical Signal Processor (Phase Selector)

The phase selector shall accommodate data-encoded communication and be able to validate, identify, classify and record the signal from the detector. It shall be located within the controller cabinet at the intersection. It will request the controller to provide priority to the requesting vehicle and/or record presence of a probe vehicle.

The optical signal processor shall interface directly with Type 2070 controllers with compatible software, and NEMA TS-1 and TS-2 with suitable system interface equipment and software.

The phase selector shall be a plug-in, two or four channel, multiple-priority device intended to be installed directly into a card rack located within the controller cabinet.

The phase selector shall be powered from 115 volt (89 volts AC to 135 volts AC), 60Hz mains and shall contain an internal, regulated power supply that supports at least four infrared detectors. The phase selector may also operate on 24 VDC

Programming the phase selector and retrieving the data stored in it shall be accomplished using a Windows™ computer and the system interface software. The connection can be made either locally, via the computer's communication RS-232 or USB COM port, or remotely via the phase selector's Ethernet port. A USB port and at least one 10/100 Ethernet port shall also be available on the phase selector. The communication protocol shall be made available upon request for creating software to implement other communication applications.

The phase selector shall include the ability to sense the green signal indications through the use of dedicated sensing circuits and wires connected between the field wire termination points in the traffic controller cabinet and the auxiliary interface panel.

The phase selector shall have the capability of storing up to 10,000 of the most recent priority control calls, probe frequency passages, or unauthorized vehicle occurrences. When the log is full, the phase selector shall drop the oldest entry to accommodate the new entry. The phase selector shall store the record in non-volatile memory and shall retain the record if power terminates. Each record entry shall include information about the priority call, as follows:

- a. Classification: Indicates the type of vehicle.
- b. Identification number: Indicates the unique ID number of the vehicle.
- c. Priority level: Indicates whether High or Low priority or Probe frequency is requested by the vehicle.
- d. Direction: Channel A, B, C, or D; indicates the vehicle's direction of travel.
- e. Time and date call started and ended: Indicates the time a priority call started and ended; provided in seconds, minutes, hours, day, month, and year.
- f. Maximum and minimum signal intensity: Indicates the strongest signal intensity measured by the phase selector during call.

- g. Priority output active: Indicates if the phase selector requested priority from the controller for the call.
- h. Relative priority: relative priority of vehicle class logged at time of call
- i. Directional priority: directional priority logged at time of call,
- j. Preempt output used
- k. No preempt cause: Indicates a history of conditions, which may have prevented a call or caused a call to terminate.

The following diagnostic tests are incorporated in the phase selector:

- Power up built in test.
- Preemption output test call

The phase selector shall be capable of call bridging. Call bridging enables the treatment of two vehicles requesting priority activation to have their calls linked together to hold a call to the controller so that they may traverse the approach together.

Relative priority allows emitter classes to be used as an additional level of prioritization within priority levels (i.e. high and low priority levels have different sets of relative priorities). If the phase selector is capable of relative priority, it shall support at least 10 unique classes in each priority level (High and Low). The relative priority class level with the highest value shall have the highest weight and 0 the lowest weight in each. If relative priority is enabled, a priority call shall be granted to the caller with the higher class level within high and low priority levels. A vehicle with a call granted, shall be able to have its call taken away by a higher level class vehicle. The system shall provide a lockout threshold that once met, shall disallow higher relative priority calls from taking away a call. Call thresholds shall be specified as intensity. The default shall be the highest level. High priority calls shall always be served over low priority calls regardless of either's relative class. Preemption for vehicles with the same base priority (high, low) and the same relative priority is done using the default first come, first served mechanism. Relative priority is capable of being enabled or disabled using system software. Relative priority for high and low can be separately enabled or disabled using system software. The default settings for all relative priority (high and low) values shall be the highest level. Relative priority shall be disabled by default for both high and low priority.

The phase selector shall include several control timers that will limit or modify the duration of a priority control condition, and can be programmed from a Windows™ computer. The control timers shall be as follows:

MAX CALL TIME: Shall set the maximum time a channel is allowed to be active. It shall be settable from 60 to 300 seconds in one-second increments.

CALL HOLD TIME: Shall set the time a call is held on a channel after the priority signal is no longer being received. It shall be settable from one to 255 seconds in one-second increments. Its factory default must be six seconds.

CALL DELAY TIME: Shall set the time a call must be recognized before the phase selector activates the corresponding output. The factory default shall be zero seconds. If the City desired to use this feature, it shall be settable from zero to 255 seconds in one-second increments.

The phase selector's default values shall be re-settable by the operator using the interface software.

The phase selector shall be capable of three levels of discrimination of data-encoded infrared signals, as follows:

- a. Verification of the presence of the base infrared signal of either High priority, Low priority or Probe frequency.
- b. Validation of the infrared signal data-encoded pulses.
- c. Determination of when the vehicle is within the prescribed range.

The phase selector's card edge connector shall include primary infrared detector inputs and power outputs. Two additional detector inputs per channel shall be provided on a front panel connector.

The phase selector shall include one opto-isolated NPN output per channel that provides the following electrical signal to the appropriate pin on the card edge connector:

- a. 6.25Hz  $\pm$  0.1Hz 50% on/duty square wave in response to a Low priority call.
- b. A steady ON in response to a High priority call.

The phase selector shall accommodate two methods for setting intensity thresholds (emitter range) for high and low priority signals:

- a. Using a data-encoded emitter with range-setting capability.
- b. Inputting the range requirements via the interface software.

The intensity range thresholds shall be programmable.

The phase selector shall have a Status LED indicator that indicates that the unit is powered.

The phase selector shall have a High (High) and Low (Low) LED indicator for each channel to display active calls.

The phase selector shall have a test switch and a select switch to test proper operation of High or Low priority.

The phase selector shall properly identify one High priority call with the presence of 10 other Low priority data-encoded emitter signals being received simultaneously on the same channel.

The phase selector shall have the capability to enter unique names for each channel via the interface software.

The phase selector shall provide one isolated confirmation light control output per channel. These outputs are user configurable through software for a variety of confirmation light sequences.

The phase selector shall also have the option of providing separate outputs for High and Low priority calls for controllers that do not recognize a 6.25 Hz pulsed Low priority request.

The phase selector shall have the capability of recording the presence of a vehicle transmitting at the specified Probe frequency. The phase selector shall at no time attempt to modify the intersection operation in response to the Probe frequency.

The phase selector shall have the capability to assign a relative priority to a call request within High or Low priority. This assignment will be based on the received vehicle class.

The phase selector shall have the capability to discriminate between individual ID codes, and allow or deny a call output to the controller based on this information.

The phase selector shall have the capability to log call requests by unauthorized vehicles.

The phase selector shall incorporate a precision real time clock.

The clock shall have the capability to automatically adjust itself for changes in daylight saving time. Interface software shall be able to set the clock and to input the appropriate dates and times for daylight saving changes.



The phase selector shall have the capability to set the minimum time between Low priority calls.

An auxiliary interface panel shall be available to facilitate interconnections between the phase selector and traffic cabinet wiring.

6. Interface Software:

Interface software shall be provided to manage phase selector and vehicle equipment while on-site at the intersection.

The on-site software shall be provided on memory stick, CD-ROM or via download from the vendor's website.

The on-site software shall be supported on Windows™ XP and Windows™ 7 operating systems.

The vendor shall provide minimum hardware configuration information for computer(s) running the on-site software.

The on-site software shall provide context-sensitive online help.

The on-site software shall allow the user to view and update all programmable configuration parameters of the phase selector and vehicle equipment.

The on-site software shall allow the user to provide intersection name and approach names for each of the four channels and store these as part of the phase selector configuration.

The on-site software shall allow the user to view and update valid and blocked vehicle codes for the phase selector.

The on-site software shall allow the user to save the configuration from the phase selector to a file.

The on-site software shall allow the user to restore the configuration for a phase selector from a saved configuration file.

The on-site software shall allow the user to print the phase selector configuration.

The on-site software shall allow the user to view the activity log from the phase selector.

The on-site software shall allow the user to save the activity log to a file.

The on-site software shall allow the user to print the activity log.

The on-site software shall allow the user to update firmware for all upgradable modules of the phase selector and vehicle equipment.

The on-site software shall display current status of all vehicles within range of the phase selector. The following details shall be tracked:

- a. The approach channel
- b. Vehicle ID
- c. Priority level
- d. Preempt / priority status
- e. Emitter intensity level
- f. Active preemption / priority output
- g. Indication if vehicle is in range.
- h. No preempt cause

C. Environmental

All equipment supplied as part of the optical preemption traffic control system intended for use in the controller cabinet shall meet the electrical and environmental specifications spelled out in the NEMA Standards Publications TS2-1992 Part 2 where applicable.

D. Qualifications

The manufacturer or their qualified agents shall supply a list of at least five preemption system users having experience with the various types of preemption system components available from the manufacturer for a minimum of three years.

Manufacturers shall be able to demonstrate the ability to provide on-going technical and product warranty support.

Manufacturer or the manufacturer's representative shall provide responsive service before, during and after the installation of the priority control system. The manufacturer or the manufacturer's representatives shall provide training to the system installer and maintenance department of the purchasing agency. Training shall consist of proper installation and operating procedures for the system hardware and software.

E. Warranty

The manufacturer of the required priority control system shall warrant that, provided the priority control system has been properly installed, operated and maintained, component parts of a matched component system that prove to be defective in workmanship and/or material during the first five (5) years from the

date of shipment from the manufacturer shall be covered in a documented system-protection plan. Additionally, the manufacturer must provide an added five-year maintenance plan for repair or replacement for a total of ten (10) years of product coverage.

The protection plan shall warrant that component parts of a matched component system that are not subject to coverage limitations and prove to be defective in workmanship and/or material during the first five (5) years from the date of shipment from manufacturer shall be repaired at no charge, and that extended coverage shall be available for an additional five (5) years.

In total, the warranty/maintenance coverage must assure that system components shall be available to allow system operation during the ten (10) year warranty/maintenance coverage.

A copy of the manufacturer's written warranty outlining the conditions stated above shall be supplied with the bid. Coverage and coverage limitations are to be administered as detailed in the manufacturer's Warranty/Maintenance document.

F. Contractor Work Tasks

The Contractor shall:

- a. Provide all PVDCS materials and equipment, mounting hardware, wiring, cables, optical detectors, confirmation light assemblies and bulbs, phase selectors, mounting brackets, detector connection cables, cable termination strips, communication cables, test equipment and computer software and other items as required. Install optical detectors with confirmation light assemblies at the locations shown on the Plans.
- b. Aim, orient, test operate and demonstrate that the optical detectors at each intersection provide effective EVP system operation as required for the conditions shown on the Plans.
- c. Install detector and confirmation light wiring from the detector device to a controller cabinet terminal strip.
- d. Provide installation assistance services and support to the City during controller cabinet hookup and connection of the Contractor furnished in-cabinet materials by the City to provide the operations and service described herein.
- e. Demonstrate correct operation of each properly equipped and operational intersection to serve as acceptance tests of the PVDCS system and components.
- f. Provide system and component documentation.
- g. Provide system and component application and maintenance training to support the proper installation and operation of system components.
- h. Provide PC-based software and interconnection cables to fully implement all components into a complete operational system.

## G. City Work Tasks

City forces shall:

- a. Furnish necessary qualified staff to attend application and training seminars.
- b. Furnish and install all controllers, controller equipment and cabinets.
- c. Install and connect all Contractor furnished PVDCS in-cabinet equipment.
- d. Connect Contractor installed optical detector wires to in-cabinet equipment.
- e. Connect Contractor installed confirmation light wires to in-cabinet equipment.
- f. Connect Contractor provided cable between the signal greens and the phase selector inputs.
- g. In general, install and connect all Contractor furnished in-cabinet equipment and cables.

## H. Optical Detector Mounting and Confirmation Light Assembly

Combination optical detector mounting and confirmation light assemblies shall be furnished and installed at each intersection as shown on the Plans.

Each assembly shall be made up from UL listed standard electrical hardware to provide a sturdy and weatherproof assembly suitable for mounting optical detectors and confirmation lights.

Each assembly shall be designed to mount two optical detectors and two confirmation lights. When less than two optical detectors or confirmation lights are used, the unused mountings shall be capped or plugged in an approved manner.

Each confirmation light assembly shall consist of incandescent lights that shall operate in conjunction with the PVDCS to indicate the occurrence of a high priority preemption call.

Confirmation lights shall be wired to provide confirmation for each preemption phase.

An illuminated solid white light shall be displayed to the directions of traffic flow represented by the preempt phase, illuminated flashing white lights shall be displayed to all other approaches.

Confirmation displays shall only be used with emergency vehicle or rail preemption.

Reflectorized outdoor type flood lamps shall be provided for each confirmation lamp holder by the Contractor.

## I. Priority Control Interface Software

The Contractor shall provide PVDCS PC based software to enable direct uploading and downloading of settings and control commands and the downloading of data describing priority vehicle operation.

The PVDCS interface software shall be provided on CD-ROM. It shall run on IBM compatible computers with XP & 7 software, a touchpad and keyboard.

It shall be possible to connect a personal computer directly to the phase selector serial port to upload and download information and data. Local connection shall permit all upload and download operations to be provided in the field.

The Contractor-supplied priority control interface software shall enable:

- Setting up and presenting user-settable system parameters
- Viewing and changing settings

- Viewing activity screens
- Displaying and downloading records of previous activity showing all items of recorded information

The Contractor-supplied priority control interface software shall accommodate operation via the keyboard and touchpad.

The Contractor-supplied priority control interface software shall provide menu displays to enable:

- Establishing signal intensity thresholds (detection ranges), timing parameters, modem initialization, and intersection name.
- Resetting and/or retrieving logged data and priority vehicle activity.
- Setting of desired green signal indications during priority control operation, and upload and download capability to view.
- Addressing for each card in a multi-drop connected system.
- Confirmation light configuration when optical signal processor driven.
- NEMA control parameters.

#### J. Optical Detector Installation Requirements

The Contractor shall install optical detector and confirmation light assemblies and shall wire each intersection as shown on the Plans and as required herein.

The Contractor shall assemble and install the optical detectors in accordance with detector manufacturer's recommendations and these special provisions.

The Contractor shall construct each optical detector mounting and confirmation light assembly from standard UL listed electrical construction hardware. Each assembly shall consist of a steel nipple with top and bottom locknuts, a four-way steel Crouse-Hinds conduit with a gasketed, screw retained cover, a short optical detector connection nipple with top and bottom locknuts, optical detector(s) and one or two screw mount incandescent flood lamp holders with flood lamps. The conduit and each flood lamp assembly shall be designed, constructed and finished for outdoor use. The flood lamp holder shall be Carlon Model P80010-HCD Nonmetallic Weatherproof Lighting System Lampholder or City of Minneapolis approved equal. Gaskets shall be provided and installed on the conduit cover and around the flood lamp base to provide a weatherproof assembly. The assembled parts shall be arranged with both conduit and terminal compartment covers facing in vehicle approach direction. Hardware shall be provided to allow signal mast arm, or pedestal mounting as indicated in the Plans.

The nipple length, optical detector position and flood light final alignment shall provide at least 6 inches of separation between the optical detector and the lamp. Reflectorized, outdoor type 40-watt flood lamps shall be provided.

After assembly, aiming, tightening and final mounting on the mast arm or pedestal pole, all extension hardware and exposed threads shall be painted the

same color as signal framework or mast arms to which they are attached. Contractor shall secure paint to insure added components match the color of supporting facilities.

All assemblies whether for one optical detector and one confirmation light or for more than one optical detector or confirmation light shall utilize a 1-inch nominal conduit and nipples.

Threaded caps or plugs shall be used to cover any unused mounting holes. Optical detector unit drain holes shall be oriented as recommended by the manufacturer.

The Contractor shall mount the optical detector mounting and confirmation light assembly on the top edge of the mast arms. Mounting hubs shall be located at 2 ft., 4 ft., and 6 ft. from the end of the mast arm as shown on the Plans or as directed by the Engineer. In any event, the final mounting position shall be adjusted to provide lateral clearance between.

Traffic signal heads and traffic signs shall be adjusted to provide a clear line of sight for priority vehicles.

The Contractor shall either have hubs for mounting attached during pole manufacturing. If hub locations are not useable the Contractor shall mount the optical detector and confirmation light assembly using a Frey Manufacturing Model KBR- ¾-inch pipe thread hub. The Contractor shall follow the manufacturers recommended installation instructions to properly align the drilled hole. Each mast arm mounting shall be installed such that the finish detector mounting shall be plumbed perpendicular to the earth.

The Contractor shall install enough cable to ensure sufficient unsliced length to connect the optical detector and confirmation light assembly fixtures at the top of signal poles or mast arms to the controller cabinet. Strain relief shall be provided in all poles for detector and indicator cables.

All field wiring shall be furnished, installed and connected to the field units. All wiring shall run to the controller cabinet and shall be coiled at the controller cabinet as directed by the Engineer. Each lead shall be taped to exclude moisture and be tagged to indicate phase and function.

#### K. PVDCS System Acceptance and Testing

The Contractor shall provide information describing the proposed equipment including unit specifications and certifications that the furnished equipment conforms to the manufacturer's specifications and these special provisions. The Contractor shall also conduct tests to verify the operation of the furnished materials and equipment and to verify the proper installation of system components.

After all field connections have been completed and wiring is connected at the controller cabinet, the City shall conduct component operations and aiming verification tests.

The tests shall verify that:

- The appropriate vehicles were detected and identified and that the appropriate outputs are generated.
- The zone of detection was appropriate for each type of vehicle.
- The Contractor shall have appropriately equipped personnel on-site to correct any problems associated with the Contractors work.

L. PVDCS Training and Documentation

If the PVDCS hardware and/or software is of a different manufacture than that which is currently utilized by the City, the Contractor shall provide a training session covering installation, maintenance and repair of all PVDCS components provided under this contract. The Contractor shall provide manuals for the training activities and to support the operation of the system.

The Contractor shall provide hookup and connection details as required to enable the proper operation of the PVDCS equipment in the field.

Documentation shall also be provided describing each of the PVDCS software programs furnished to meet the requirements of this project.

It is understood that the programs provided for this project are the property of the Manufacturer or others. The programs provided shall, however, be for unlimited licensed use by the City of Minneapolis. It is also required that the City be permitted to make any number of copies of the program for use by City forces. The City shall not distribute or otherwise make available copies of the program or programs to any other party unless specifically authorized by the Manufacturer or owner of the software.

M. PVDCS Measurement and Payment

Furnishing and installing materials and electrical equipment as specified herein, all to provide an installed and successfully tested Priority Vehicle Detection and Control System at each intersection shall be considered incidental work to each new permanent traffic control signal system and no direct compensation shall be made therefore.



**SS-1.7 Method of Measurement and Payment****A. Purpose**

This section shall define the bid items and the manner in which payment will be made to the Contractor.

**B. Miscellaneous Work, Equipment, and Material**

Items of miscellaneous work, equipment and material will be required to construct each system including such items as flagmen and traffic control personnel, traffic cones, markers, flashers, barricades, bolts, nuts, washers, electrical wire, etc. In each case where these items or similar miscellaneous items are necessary to the completion of the project in a safe and reliable fashion, their provision, use and installation by the Contractor shall be considered included in the various associated items of work and no direct payment will be made therefor.

The Contractor shall not receive full payment for the installation of any traffic signal system nor will the City take over maintenance responsibility for the signal system until the City of Minneapolis performs a punch list inspection of the installed facilities and all noted discrepancies are corrected by the Contractor to the satisfaction of the City.

C. Measurement

1. Furnishing and installing all materials and electrical equipment (except for an intersection traffic signal cabinet complete with controller unit and all required signal control equipment which will be furnished and installed by the City of Minneapolis); all to provide complete fully operational Traffic Control Signal Systems “A”, “B”, “C”, “D”, “E”, “F” and “G” in Minneapolis as contained in these Special Provisions and in the Plans will be measured as an integral unit complete in place and operating.
2. Removing and salvaging an existing traffic control signal system at: Systems “A”, “B”, “C”, “D”, “E”, “F” and “G” as contained in these Special Provisions and in the Plans will each be measured as an integral unit.

Removal of asbestos containing electrical conduits (transite) shall be paid as part of the lump sum cost for Salvage Signal System.

D. Basis of Payment

1. Payment for traffic control signal system installation shall be in accordance with MnDOT 2565.4 and MnDOT 2565.5 respectively for a Fully Operational Signal System. Payment shall be compensation in full for all costs of furnishing and installing signal equipment, poles, pedestals, luminaires, foundations, conduit, handholes, cable, signal service and equipment, and all incidentals in accordance with the following schedule at the appropriate contract bid price for the specified unit of measure.

<u>ITEM NO.</u>	<u>DESCRIPTION</u>	<u>UNITS</u>
2565.516	Traffic Control Signal System "A"	Signal System
2565.516	Traffic Control Signal System "B"	Signal System
2565.516	Traffic Control Signal System "C"	Signal System
2565.516	Traffic Control Signal System "D"	Signal System
2565.516	Traffic Control Signal System "E"	Signal System
2565.516	Traffic Control Signal System "F"	Signal System
2565.516	Traffic Control Signal System "G"	Signal System

2. Payment for removing and salvaging existing traffic control signal systems shall be in accordance with MnDOT 2565.4 and MnDOT 2565.5 respectively Salvage Signal System. Removing and disposing of traffic signal foundations and handholes containing asbestos shall be included in the lump sum price per system. Payment shall be compensation in full for all costs of salvaging, removing and disposing of signal equipment, poles, pedestals, luminaires, foundations, conduit, handholes, cable, service cabinets, hazardous materials, and all incidentals in accordance with the following schedule at the appropriate contract bid price for the specified unit of measure.

<u>ITEM NO.</u>	<u>DESCRIPTION</u>	<u>UNITS</u>
2104.601	Salvage Signal System "A"	Lump Sum
2104.601	Salvage Signal System "B"	Lump Sum
2104.601	Salvage Signal System "C"	Lump Sum
2104.601	Salvage Signal System "D"	Lump Sum
2104.601	Salvage Signal System "E"	Lump Sum
2104.601	Salvage Signal System "F"	Lump Sum
2104.601	Salvage Signal System "G"	Lump Sum

**SS-2 (2565) TRAFFIC CONTROL Interconnection**

This work shall consist of installing all materials and equipment as shown on the Plans, to provide a complete, operating communication line between the following traffic signal control systems:

Interconnection of Systems "A" through "G" along XXX street and XXX Avenue and to each other, and installing or removing and reinstalling interconnect to other signal systems as shown on the Plans.

The electrical system shall comprise all of the work shown in the Plans including, but not limited to, installing the conduit, handholes and interconnect cable into the controller cabinets via handholes and conduits, and removal of the in-place communication cable, all in accordance with the Specifications, except as shown or noted in the Plans and modified in these Special Provisions.

Removal and disposal of the existing interconnect conduit and handholes shall be paid for under separate bid item. Existing interconnect cable removal shall be incidental to the Traffic Control Interconnect installation bid item.

**SS-2.1 Electrical (Communications) System**

The in place and new communication system within the project area shall be located in in place or new conduit as noted in the Plans. In place communication cable shall remain in place and in operation until such time as the in place traffic signal systems are turned off, a roadway is closed and the various interconnect functions are no longer necessary.

**A. Removal of In place Communications Cable**

Prior to removal of the existing communications system, the City of Minneapolis shall be notified so that appropriate steps may be taken to disconnect communications equipment at adjacent traffic signal installations. The communications cables shall be disconnected at each control cabinet by City forces, and with the approval of the City may then be removed by the Contractor.

Salvaged cable shall be coiled and tagged in accordance with the requirements of SS-1.4.

**B. (2565.603) XX Pair Conductor, Number 19**

Communication cable shall be a XX Pair conductor, No. 19 AWG Cable as noted in the Plans. The cable shall be a multi-conductor, grease-filled, telephone cable designed for conduit and direct burial application.

The cable shall be double jacketed and conform to a modified version of the requirements of Rural Utilities Service (RUS) Specification 1755.390 latest edition. The specification modification consists of provision of double

jacketing with the inner and outer jackets constructed in conformance with the requirements of ANSI/ICEA S-84-608-1988 paragraph 7.1 and 7.2.

Individual conductors shall be solid and No. 19 AWG. There shall be a single shield that shall be either fully annealed solid copper, Alloy 194, or fully annealed copper-clad stainless steel.

The following summarizes the primary requirements:

1. XXX Pair No. 19 AWG.
2. The cable is fully color-coded so that each pair in the cable is distinguishable from every other pair.
3. Each conductor shall be a solid round wire of commercially pure annealed copper.
4. Each conductor shall be insulated with a colored, solid insulating grade, high-density polyethylene or crystalline propylene/ethylene copolymer.
5. The insulated conductors shall be twisted into pairs. The twisted pairs shall be assembled in such a way as to form a substantially cylindrical group (cable core).
6. A petrolatum-polyethylene filling compound shall completely coat each insulated conductor and fill the air space between the conductors.
7. The cable core shall be completely covered with a layer of nonhydroscopic and nonwicking dielectric material. The covering shall be applied with an overlap.
8. An inner jacket applied over the cable core covering. The jacketing grade material used for the inner jacket shall be low density, high molecular weight polyethylene in accordance with ANSI/ICEA S-84-608-1988 paragraph 7.1/7.2.
9. A single corrugated metal shield shall be applied longitudinally with an overlap over the inner jacket. The metal shield shall be for “Gopher Resistant Cable” and shall be either **10-mil fully annealed solid copper, 6-mil 194 Alloy, or 6-mil fully annealed copper clad stainless steel.**
10. An outer jacket shall be applied over the metal shield and inner jacket. The jacketing grade material used for the outer jacket shall be low density, high molecular weight polyethylene in accordance with ANSI/ICEA S-84-608-1988 paragraph 7.1/7.2.
11. The cable shall be marked on the outer jacket with product description, year of manufacture, and sequential footage marks at two-foot intervals.

The City of Minneapolis Traffic and Parking Services shall be provided the opportunity to review and approve or disapprove the proposed communications cable before it is installed.

C. Installation of Communications Cable

Interconnect cable runs shall be installed as continuous runs, unless splices are specified. Approximately six (6) feet of slack cable shall be provided in each handhole through which the run of interconnect cable passes. Each interconnect cable entering the controller cabinets shall provide six (6) feet of slack cable within the controller cabinet and shall be permanently labeled as “East” or “West” or “North” or “South” to identify the direction of interconnect cable run. Such identification shall be affixed immediately on installation of the cable into the cabinet foundation. **A pull rope, approved by the City, shall be installed in each conduit along with each run of communication cable.**

D. Communication Handholes (Pull Boxes)

All interconnect handholes shall be the Minneapolis standard communication HDPE rectangular fiber vault handhole per Minneapolis standard plate TRAF-2710-R2 and installed per Mpls standard plate TRAF-2715-R1. Any old steel handholes containing interconnect and disturbed by the project shall be replaced with the aforementioned HDPE vault.

**SS-2.2 Method of Measurement and Payment**

A. Measurement

Furnishing and installing all materials to provide a complete, useable interconnect system as contained in these Special Provisions and in the Plans will be measured as described below.

The Contractor shall not receive full payment for the installation of any traffic signal interconnection system until the City of Minneapolis performs a punch list inspection of the installed facilities and all noted discrepancies are corrected by the Contractor to the satisfaction of the City.

B. Payment

The conduit, handholes, cable system, pull rope and miscellaneous work, equipment and material required to construct each Traffic Control Interconnection System shall be paid for as listed below. Payment at the contract unit price shall be compensation in full for all costs of furnishing and installing all materials and incidentals required to provide the system as specified and as shown in the Plans.

<u>ITEM NO.</u>	<u>DESCRIPTION</u>	<u>UNITS</u>
-----------------	--------------------	--------------

2565.501 Traffic Control Interconnection Lump Sum

**SS-3 (3815) Fiber Optic Cable**

**SS-3.1 Fiber Optic Cable and Testing**

This work shall consist of furnishing and installing a fiber optic cable of the type, size and number of fibers specified.

**A. General Requirements**

**1. Materials and Equipment**

Materials and equipment shall be the standard products of a manufacturer regularly engaged in the manufacture of the products.

**2. Contractor Qualifications**

Trained and experienced personnel shall supervise the fiber optic cable installation. Qualified technicians shall make the cable terminations and splices. The Contractor upon request of the Engineer shall provide documentation of qualifications and experience for fiber optic equipment installations. The Engineer shall determine if the Contractor is qualified to perform this work. The Contractor shall have attended a certified fiber optic training class mandated by these specifications prior to starting work.

**3. Codes Requirements**

The fiber optic cable installation shall be in accordance with or exceed all minimal requirements of State codes, National codes, and manufacturer codes as applicable.

**4. Miscellaneous Equipment**

The Contractor shall furnish and install all necessary miscellaneous connectors and equipment to make a complete and operating installation in accordance with the Plans, standard sheets, standard specifications, special provisions, and accepted good practice of the industry.

**5. General Considerations**

The cable shall meet all requirements stated within this specification. The cable shall be new, unused, and of current design and manufacture.

**6. Shop Drawings**

The Contractor shall furnish to the Engineer, for approval by the City of Minneapolis Traffic and Parking Services, electronic pdf file and specification of the fiber optic cable and glass type. Upon request, the Contractor shall supply a sample of the proposed cable to the City.

## 7. Fiber Cable Requirements

### a. Single Mode 24 Fiber - Fiber Optic Cable

The fiber optic cable shall be OFS ALLWave, Corning or City of Minneapolis approved equal conforming to the following specifications. The fiber optic shall be manufactured utilizing Corning or OFS glass fiber conforming to the following specifications. All materials and equipment furnished shall be completely free from defects and poor workmanship. All fibers shall be glass and be manufactured by Corning, OFS or City of Minneapolis approved equal. The cable shall be rated for gigabyte data bandwidth.

All fiber shall be loose tube construction for both indoor and outdoor installation. Where indoor cabling is specified, the indoor cabling shall use plenum rated conduit to within less than 50 feet of point of termination eliminating the requirement to convert to indoor cable.

All fibers in the cable must be usable fibers and meet required specifications.

- Single-Mode Fiber
- Typical core diameter: 8.3um
- Cladding diameter: 125 +1.0um by fiber end measurement
- Core-to-cladding offset: <1.0um
- Coating diameter: 250 +15um
- Attenuation uniformity: No point discontinuity shall be greater than 0.1 dB, except terminations or patch cords, at either 1310nm or 1550nm. The coating shall be a layered UV cured acrylate applied by the fiber manufacturer. The coating shall be mechanically or chemically removable without damaging the fiber.
- Factory cable rating shall be 0.35 dB/KM at 1310 nM and 0.25 dB/KM at 1550 nM. Installed tolerance shall be less than 0.44 dB/KM at 1310 nM and less than 0.33 dB/KM at 1550 nM, testing tolerance.
- All fiber cables shall be Gigabyte rated, i.e. single mode shall be 28 KM for 1310 nM and 40 KM for 1550 nM based on a 10 dB power budget.
- All Single mode fiber shall be rated for multi-frequency, four frequencies, equivalent to the AllWave OFS specification and shall be rated to withstand extended aging under water impregnation conditions.

All fibers in the cable shall meet the requirements of this specification. The testing tolerance attenuation specification shall be a maximum



attenuation for each fiber over the entire operating temperature range of the cable when installed.

The change in attenuation at extreme operational temperatures for single-mode fibers shall not be greater than 0.20 dB/km at 1550 nm, with 80 percent of the measured values no greater than 0.10 dB/km at 1550 nm.

Optical fibers shall be placed inside a loose buffer tube, twelve (12) fibers per tube.

The buffer tubes will meet EIA/TIA-598, "Color coding of fiber optic cables."

Where multimode fiber is specified, single-mode fibers shall be placed in the first buffer tubes with multimode fibers in the remaining buffer tubes following single mode. Fiber count, tubes of fiber, shall be as specified on the Plans.

Fillers shall be included in the cable core to lend symmetry to the cable cross-section where needed.

The central anti-buckling member shall consist of a glass reinforced plastic rod.

The cable shall use a completely dry cable design without the use of gels and filling compounds. Dry water blocking material shall be used around the buffer tubes as well as internal to the tubes. Water blocking gels shall not be acceptable on this project. Gel, a.k.a. "icky-pic", shall not be acceptable for this project.

Buffer tubes shall be stranded around a central member. Acceptable techniques include the use of the reverse oscillation, or "SZ", stranding process.

**All dielectric cables (with no armoring) shall be sheathed with medium density polyethylene.** The minimum nominal jacket thickness shall be 1.4 mm. Jacketing material shall be applied directly over the tensile strength members and flooding compound. Cable jacketing shall utilize the newer designs to provide maximum flexibility without loss or appreciable dB attenuation. Cable diameter shall not exceed 0.50 inch.

The jacket or sheath shall be marked with the manufacturer's name, the words "optical cable", the year of manufacture, number of fibers, type of fiber (SM or MM) and sequential feet or meter marks. The markings

shall be repeated every one-meter or three feet. The actual length of the cable shall be within  $-0/+1\%$  of the length marking. The marking shall be in a contrasting color to the cable jacket. The height of the marking shall be approximately 2.5 mm. A copy of the manufacturer fiber definition and shipping sheet identifying all tests, results and fiber indexes shall be provided to the Engineer on delivery of cable to the City or shall be included with a Contractor's listing of place(s) of installation when installed by a Contractor.

Buffer tube and fiber color coding shall be as follows:

<u>Buffer Tube/Fiber</u>	<u>Tube/Fiber Color</u>
#1, 1st tube or fiber	blue
#2, 2nd tube or fiber	orange
#3, 3rd tube or fiber	green
#4, 4th tube or fiber	brown
#5, 5th tube or fiber	slate
#6, 6th tube or fiber	white
#7, 7th tube or fiber	red
#8, 8th tube or fiber	black
#9, 9th tube or fiber	yellow
#10, 10th tube or fiber	violet
#11, 11th tube or fiber	rose
#12, 12th tube or fiber	aqua

All optical fibers shall be proof tested by the fiber manufacturer at a minimum load of 100 kpsi.

All optical fibers shall be 100% attenuation tested at the manufacturer. The attenuation of each fiber shall be provided with each cable reel. The measured attenuation shall be for both 850 and 1300 frequency for multimode and 1310 or 1550 frequency for single mode. This documentation shall be provided with each spool. The Contractor shall designate on the Plans and on this documentation the location where each spool has been installed and provide this data to the Engineer.

b. Single Mode 6 Fiber Armored - Fiber Optic Cable

The Fiber Optic Cable Assemblies for Fiber Optic Cable shall comply with USDA RUS CFR 1755.900 (Specification for Filled Fiber Optic Cables) shall be shown on the MnDOT Qualified Products List and shall comply with the following provisions:

- Fiber Optic Cable shall be designed for outdoor use and direct bury
- Include a dielectric central strength member.
- Armored with corrugated steel tape.

- Minimum of a 1.3 mm thick Medium Density Polyethylene outer jacket;
- Include two ripcords. One ripcord under the armor and one ripcord under the inner jacket.
- Outside diameter of < 23 mm (0.906 inch).
- Indented markings on one-meter (three-foot) intervals showing the manufacturer, fiber count, MnDOT part number, mode, and length in meters.
- Buffer Tubes
  - Filled with fibers according to the following:
    - For < 48 fibers there shall be 6 fibers per buffer tube.
    - For > 48 fibers there shall be 12 fibers per buffer tube.

Constructed for direct burial applications per the above referenced USDA specification.

Color-coded per ANSI, TIA, EIA 598A, thermoplastic, and gel filled.

Have an outside diameter ranging from 1.9 mm (.075 inch) to 3.0 mm (0.118 inch).

Stranded around the dielectric central strength member using the reverse oscillation stranding process.

Covered with water blocking tape.

Dielectric strength members (yarns) woven longitudinally between the outside of the Buffer.

Tubes and the inner jacket.

- Inner Jacket
  - Made of Medium Density Polyethylene.
  - Minimum of 0.50 mm (0.02 inch) thickness.
  - Applied directly over tensile strength members and water blocking material.
- EIA Class IV SM Fibers
  - Can be mechanically stripped.
  - Diameter of the cladding shall be  $125 \mu\text{m} \pm 1 \mu\text{m}$ .
  - Diameter of the coating shall be  $245 \mu\text{m} \pm 10 \mu\text{m}$ .
- Coating shall be a dual layer of acrylate coating in physical contact with the cladding surface;
- SM fibers shall have a ZDW of 1300 to 1321.5 nm.
- Cutoff wavelength < 1260 nm.
- Maximum attenuation at 1310 nm shall be 0.35 dB/km and 0.25 dB/km or less at 1550 nm.

- Attenuation requirements shall be measured along the cable axis.
- Mode field diameter shall be between 8.8 and 9.8  $\mu\text{m}$  at 1310 nm and between 9.9 and 10.8  $\mu\text{m}$  at 1550 nm.
- Maximum dispersion shall be  $< 3.2 \text{ ps/nm}^2\cdot\text{km}$  from 1285 to 1330 nm and  $< 18 \text{ ps/nm}^2\cdot\text{km}$  at 1550 nm.
- Core-to-cladding offset (Core/cladding concentricity) shall be  $< 0.6 \mu\text{m}$ .
- Factory fusion splices shall not be allowed.

MnDOT approved 6 Single Mode Armored Fiber Optic Cables are listed on the MnDOT Qualified Products List WEB site for Fiber Optic Cables:

<http://www.dot.state.mn.us/products/tms-its/fibercables.html>

## 8. Fiber Installation

### a. Cable Installed in Ducts and Conduits

A suitable cable feeder guide shall be used between the cable reel and the face of the duct and conduit to protect the cable and guide it into the duct off the reel. It shall be carefully inspected for jacket defects. Fiber optic cable feeders shall be placed at all handholes where the cable must make sharp bends or hand feeding must be done, as determined best by Contractor. If defects are noticed, the pulling operation shall be stopped immediately and the Engineer notified. Precautions shall be taken during installation to prevent the cable from being “kinked” or “crushed”. A pulling eye shall be attached to the cable and used to pull the cable through the duct and conduit system. A pulling swivel shall be used to eliminate twisting of the cable. As the cable is played off the reel into the cable feeder guide, it shall be sufficiently lubricated with a type of lubricant recommended by the cable manufacturer. Dynamometers or breakaway pulling swing shall be used to ensure that the pulling line tension does not exceed the installation tension value specified by the cable manufacturer. The mechanical stress placed on a cable during installation shall not be such that the cable is twisted or stretched. The pulling of cable shall be hand assisted if needed at each handhole, or cabinet foundation. The cable shall not be crushed kinked or forced around a sharp corner. If a lubricant is used it shall be of water based type and approved by the cable manufacturer. **Prior to fiber termination, sufficient slack shall be left at each end of the cable to allow proper cable termination, minimum of 70 feet.** This cable termination slack shall be allowed for waste in fiber termination procedure. Cable installed with less than the specified slack shall be replaced for the entire length by the Contractor. If Contractor wishes, and city agrees, and short cable

meets good light test measures, contractor may opt to settle for 50% payment of fiber optic cable (for the length of fiber optic cable with too little slack) in lieu of replacement of entire length and retesting and reterminating.

All fiber terminations and splices shall be performed by City of Minneapolis.

- b. **Fiber Optic Cable Marking Conductor**  
Along with the fiber optic cable, one (1) #10 AWG THHN, 600 volt single conductor cable (identifier conductor/tracer wire), orange in color, shall be pulled with ten feet (10') slack in each handhole where slack fiber cable is required. All tracer wires shall be spliced together in the fiber hub cabinet or traffic signal cabinet. Each tracer wire shall be taped to its associated fiber-optic cable and/or labeled to indicate the tracer wire direction. All tracer wires shall be terminated to the grounding electrode system. Pull rope shall be included with tracer wire.
- c. **Fiber Optic Cable Labeling.**  
Inside each handhole and inside each cabinet, the Contractor shall place a metallic label on each fiber optic cable. The fiber optic cable label, shall indicate the direction the cable is going, cable contents [SM or SM/MM], and the abbreviated location for the other end destination. Cabling between traffic controllers and adjacent hub locations shall, typically, be Cat 5-E patch cords. Where distances are long, the cabinets will be connected by fiber optic cable, as shown in the Plans.
- d. **Minimum Bend Radius**  
For static storage, the cable shall not be bent at any location to less than ten times the diameter of the cable outside diameter or as recommended by the manufacturer. During installation, the cable shall not be bent at any location to less than twenty times the diameter of the cable outside diameter or as recommended by the manufacturer.
- e. **Fiber Optic Cable Testing**  
After fiber termination is complete, Contractor shall test all fibers. Non-terminated fibers shall be tested with an OTDR. Terminated fibers shall be tested with a power meter and with an OTDR. The Contractor may jumper termination points at controller cabinets to minimize the number of tests and run a single OTDR test between several controller cabinets, subject to the range of the OTDR. Contractor shall not jumper through hub

sites. Multimode fiber, when specified, shall be tested using 1300 nm and single mode fiber shall be tested at 1310 nM. Outdoor patch cords between hubs and controller units do not need be OTDR tested. Note to Contractor: Fiber cleaning time should be low. This is a dry-fill (non-gel) cable.

Any tests which can be field identified as out of range shall be tracked down and corrected. Additional tests may be run after each correction. Splices will not be allowed to repair a damaged section. When a satisfactory light wave test results, only the final test result need be submitted. The Contractor shall record the fiber optic cable name (end to end destination), the length of the OTDR begin test cable, the physical length of each fiber optic cable, the location of temporary jumper patch cords, if used, and the length of the OTDR end test cable.

Contractor shall provide the power meter test results and the OTDR test results to the City. The results of the OTDR test shall be provided on an electronic media (disk) and paper printout. Each OTDR trace, for documented test result submittal, shall be displayed individually and not be combined with other fiber traces as overlays. The OTDR wave, pictorial diagram of dB loss over the length of fiber tested, shall be provided along with the measured data values. The printout shall contain the manufacturer's fiber optic Index of Refraction to the third decimal point for the fiber provided. The Contractor shall provide a working copy of the program to view and set measurements of the electronic test data based on the OTDR device used for the fiber optic testing.

Documentation provided to the Engineer by Contractor shall include a written indication of every splice, termination, and patch cord for cable being measured. Power meter measurement recordings shall indicate the exact measured distance [OTDR or field measurement with cross reference for oscillation multiplier] on the sheet showing the power meter readings. Any deviations between fiber readings in the same tube shall be noted for OTDR graphs as well as deviations greater than 5% on power meter readings. Rated values for acceptable installation shall be based on the following parameters:

Patch cords/Pigtails	.60 MM & .15 SM dB each
Unicam Terminations	1.0 dB set of 2 [In and Out]
Splices	0.08 each

$$1 \text{ KM} = 0.3077 \text{ KF where KF is 1000 feet}$$

Data documentation shall include for each test between cabinets or between FDP sites, the length of fiber as measured by OTDR, frequency used in test on OTDR by each fiber type, distance to each splice, termination or patch cord jumper, dB loss rating by manufacture from spool documentation, index of refraction by type of fiber in section, and the dB loss of each section as measured in the final test for each fiber. Contractor OTDR testing shall be performed after City of Minneapolis has completed all terminations and splicing on the fiber optic system.

f. Cable Termination

Fiber optic terminations shall be performed by City of Minneapolis Traffic Department.

g. Breakout Kits

The breakout kits or termination boxes used to terminate each fiber cable in the cabinet shall provide for the separation and protection of the individual fibers with the buffer tubing and jacketing materials. The termination housing shall be installed within a wall or shelf mountable interconnect housing which shall provide for storing fibers, ample room for feed through cable, strain relief for multiple cables within unit, and accommodate LC compatible connectors. All fiber pigtailed shall be terminated through LC connectors on the wall or shelf mounted interconnect panel. All terminations shall be LC type, ceramic core (outdoor connections), and plug into the provided controller unit internal fiber optic modem. Acceptable enclosures for combination termination/splice points shall be AFL splice kit consisting of the following components with AFL part numbers and quantities listed: (4) FUSE-LC-9U-SMU-6FUSECONNECT LCU 900UM SM-6 PACK, (1) APQ1SBLZ ADAPTER PANEL 24fLCU DPLX SM, (2) C189818 FAN OUT KIT-12 FIBER LOOSE TUBE, (1) WMEO1E ENCLOSURE WALL MOUNT 1 ADAPTER PANEL, (1) FM003388 DIN RAIL CLIP, and one patch cord included with each kit or City of Minneapolis approved equal fiber splice kit. Four of the aforementioned splice kits shall be provided for each fiber hub cabinet on the project. At each signal system where no fiber hub is present, one kit per fiber cable entering the traffic signal cabinet shall be provided. All splices, not specified to be installed external to the fiber splice tray, shall be installed in splice trays and be supported with heat shrink tubing. Acceptable splice trays include AFL per above specifications or City of Minneapolis approved equal.

All splices shall be made above ground in either a fiber hub cabinet or traffic signal cabinet. For every fiber cable termination, two LC-LC patch cords shall be provided. Where a patch cord with termination block is specified, shown on the wiring diagrams, all fibers for each block utilized shall be fusion spliced from a single fiber cable, such that one block is for 'incoming' fibers and a second block is for 'outgoing' fibers. Each termination block shall be uniquely identified in the cabinet as to the location the fiber is coming "FROM". All fiber splices will be performed by City of Minneapolis Traffic Department.

h. Connectors

Connectors shall be mechanical LC (ceramic ferrule-outdoor connections) compatible, field installable, and self-aligning and centering. Connectors to the special devices used for Ethernet network connections shall utilize a factory converter cable, such as a SC to ST or manufacturer specified converter patch cord. Fiber optic equipment, used for terminating fibers, shall be rated for the type of connectors used. Connectors shall be Siecorm CamLite, UniCam, or City of Minneapolis approved equal.

i. Splices

Fiber splices shall be performed by City of Minneapolis Traffic Department with contractor supplied materials.

9. Payment

Payment shall be according to the payment schedule indicated in the Scope of Work.

The Contractor shall not receive full payment for the installation of any fiber optic cable system until the City of Minneapolis performs a punch list inspection of the installed facilities and all noted discrepancies are corrected by the Contractor to the satisfaction of the City.

Contractor shall bid this item as

"24 Fiber Single Mode Fiber Optic Cable", Lineal Foot

The unit price shall include the cost of furnishing and installing the fiber optic cable and the fiber optic cable marking cable, fiber pigtailed, cable



splicing, cable terminating, cable termination facilities, cable testing, special testing and report generation. Contract specified cable slack will be paid for at the contract unit price. Excess slack beyond contract specified amount will receive no excess payment.

## SS-3.2 Fiber Optic Hub Cabinet

### A. Construction

1. The fiber optic cabinet shall be weather proof, ground mounted, and of rigid construction fabricated from 0.125 inch thick aluminum conforming to the requirements of ASTM B 209 for 5052-H32 aluminum sheet. The cabinet shall be clean in design and appearance and have the following dimensions.

HEIGHT 63 inches

WIDTH 33 inches

DEPTH 17 inches

The cabinet enclosure shall be of good workmanship. All seams and joints shall be made smooth and even, without cracks, air leaks or pinholes. The cabinet vertical sides shall be of one continuous piece construction or shall have vertical edges joined with butted-formed flanges. Flanges shall be continuously welded, on the inside of the cabinet and sealed on the outside. There shall be no sharp or jagged edges. All interior and exterior seams shall be continuously welded and ground smooth. Sharp edges shall be filed.

The cabinet enclosure top shall be slanted 2 inches to the rear to prevent standing water and shall provide an overhang above the door at least 3 inches beyond the front of the cabinet.

Pop rivets shall not be used in the construction of the cabinet, nor in the attachment of hinges, doors, handles, or locks except as specifically permitted.

The cabinet enclosure (physical enclosure only) shall be UL listed with the UL label affixed to the inside of the cabinet, and shall carry a NEMA 3R rating to provide a degree of protection against rain, sleet, snow, and dripping water.

2. The cabinets shall have minimum 2 1/2" flanges on the inside bottom of the unit with 7/8" holes for anchor rods in the cabinet corners, as shown on drawing labeled Cabinet Enclosure Corner Brace.
3. A gasket shall be provided for mounting the cabinet enclosure on a concrete pad. The gasket shall consist of four (4) strips of 3/8-inch thick solid butyl rubber, similar to that used for industrial conveyer belts. Two (2) of the strips shall be 2.5 inches wide x 17.5 inches long, with slotted holes drilled at 15 inches center to center along the length of the strip. The slotted holes shall be centered across the width of the strip, so as to line up with the mounting holes in the cabinet enclosure bottom flange. The remaining two (2) strips shall be 2.5 inches wide x 30.25 inches long, with no holes drilled.
4. The cabinet shall have a screened rain-tight vent assembly at the top front of the cabinet. The vent assembly; shall run near the top of the front panel of the cabinet from side to side; shall be baffled to resist entrance of water into the cabinet, and shall provide drainage for any water entering the vent.
5. The cabinet shall have a reinforced, hinged full size door which, when closed, makes the cabinet weather resistant and dust tight. The door shall have a tumbler lock for a Minneapolis standard No.2 traffic signal key.

All four sides of the cabinet full size door opening shall have a formed double flange.

The door shall be equipped with a three point locking mechanism which is operated from a single easy turning handle. The upper and lower locking points of the three point locking mechanism shall each have a pair of nylon rollers.

The door handle shall be a removable 3/4 inch diameter stainless steel L-shaped hexagon rod. The handle receiver in the 3-point lock assembly shall contain a center pin, which shall be compatible with a drilled hole in the stainless steel handle. Handles and lock assemblies shall be compatible with existing City of Minneapolis cabinets. (It shall be the responsibility of the cabinet supplier to ensure compatibility). The door shall contain a swing-away cover over the handle attachment hole in the door to prevent the entry of rain and snow.

A multi-position bar stop shall hold the door open at approximately 90, 135, and 180 degrees from a closing position. The stop shall slide in a U-shaped guide along the bottom of the inside front of the cabinet.

The cabinet door shall be mounted with three (3) separate heavy-duty gauge butt hinges and mounting bolts to allow replacement of the door if damaged. Each hinge shall have 0.25-inch minimum stainless steel hinge pin.

Hinge placement shall be such that cabinet doors are interchangeable between cabinets.

All hinges, hinge pins, and locks shall be constructed of stainless steel.

The cabinet full-size door shall open to the right. When the door is closed and latched the door shall lock. The lock shall have a swing-away cover over the lock to prevent entry of ice and snow and shall be provided with two keys.

A tinned copper braided grounding conductor, properly terminated, shall ground the cabinet main door to the cabinet enclosure.

The full size door shall be gasketed with a good grade closed cell neoprene gasket attached to the door which, when closed, provides a dust tight, weather resistant seal.

6. Vertical mounting channels shall be welded to interior cabinet walls to provide adjustable shelf and panel locations. Sufficient mounting hardware shall be included to mount city supplied panels.

The cabinet enclosure shall be equipped with four (4) channels on each sidewall and three on the back wall of the cabinet enclosure. The mounting channels shall be Unistrut A4000EA and shall extend to 2" from bottom of cabinet to 2" from the cabinet roof. Each of these channels shall be welded to the cabinet in at least 5 spots. The back wall shall include an additional 4" wide continuously welded vertical channel as a stiffener to provide rigidity to the back wall.

7. The cabinet layout of the shelves, panels and equipment for this equipment application shall allow space for placing equipment on the shelves so as to provide for ease of installation and removal of the equipment and for ease of viewing of the front panel displays of the equipment.

All equipment mounted on the sidewalls of the cabinet shall be located in positions that will not interfere with the removal of other equipment, either shelf or rack mounted. Electrical equipment and terminal facilities mounted on the inside side walls and back wall of the cabinet shall be mounted on 0.090" aluminum panels with brass round head screws. The metal panels shall be attached such that no screws, bolts, pop rivets, or other fasteners go through the outside shell of the cabinet.

All panels shall be mounted such that a minimum clearance of 4 inches from the bottom of the cabinet is maintained.

**Panels shall not have sharp or jagged edges or corners.**

Uninsulated 120-volt parts of any electrical equipment inside the cabinet shall be suitably covered with Lexan and a warning label to prevent electrical shock. Lexan covers shall be held in place by large plastic or nylon wing nuts.

8. The cabinet shall be provided with adjustable shelves. The shelves shall fit the full width of the cabinet and shall be at least ten and one half inches in depth.

The shelves shall be ventilated with punched holes or fabricated from an aluminum mesh material to provide airflow. If punched holes are used each shelf shall contain twelve (12) holes, each 1.25 inches in diameter evenly distributed across the shelf in two rows.

A documentation shelf 15 inches wide by 10 inches deep shall be hung from the bottom side of the lower shelf. The document shelf shall provide 1" of document insertion space.

9. Two LED light fixtures shall be provided. One fixture shall be mounted on the inside near the top of the cabinet above the full-size door opening. The second fixture shall be mounted on the underside of the lower shelf. The fixture shall be centered on the long dimension of the shelf. Each fixture shall be UL listed, shall have multiple LED's and be Relume Technologies Model 796-5000, or GE Lumination Tetra Power Grid GEWHGP6-65K or equivalent. The fixture shall be capable of being easily removed and replaced without interference with other components in the cabinet. The light fixture shall be of a rugged design.

The light fixture shall be activated by a 2 position toggle switch located on the auxiliary switch panel and labeled "LAMP ON - OFF". The power for the light fixture shall be supplied through the accessory circuit breaker.

The lamp mount position shall not interfere with the insertion or removal of equipment to be installed on the top shelf.

10. A thermostatically controlled fan assembly containing two (2) fans, a thermostat for controlling the fans, and a 4-point "Non-feed thru Terminal Block" shall be located in the top front of the cabinet in a plenum assembly and shall exhaust air out through the screened vents built into the roof door overhang of the cabinet. Each fan shall be rated

for 100 cubic feet per minute air movement and a maximum noise level of less than 40 decibels. Fan guards shall be provided to prevent anyone from putting their fingers into the fan. Each fan motor shall have thermal locked rotor protection or shall be impedance protected. The fan thermostat shall be located in the inside top of the cabinet adjacent to the outside wall of the plenum and be adjustable within the minimum range of from +75 degrees to +150 degrees Fahrenheit. Fan attachment hardware shall have anti-seize compound added to the threads prior to assembly.

The cabinet shall be supplied with a cabinet heater and cabinet heater fan, both shall be controlled by a separate thermostat with a near freezing turn on temperature range. The cabinet heater shall be 500 watts. The cabinet heater fan shall circulate cabinet air past the heating element to maintain even cabinet air temperature.

The fans shall be separately fused and powered by the auxiliary breaker on the power panel assembly. The fan assemblies shall be provided with connectorized power connections. Exposed terminals on the thermostats shall be covered by insulation to prevent accidental contact with 120 VAC circuits. If the adjustment screw of the thermostats is covered by the insulation, a hole or door shall be provided to allow adjustment of the thermostats while giving protection from accidental contact with the 120 VAC.

Louvers shall be located in the lower portion of the main cabinet door for air intake. The louvers shall be centered horizontally in the door and be placed in four (4) columns of ten (10) louvers, spaced 1-inch apart, covering a total area of approximately 22 inches wide by 10 inches high. The louvers shall be backed by a size 12 inches by 24 inches by 1-inch thick replaceable type foam panel type dust filter (Viskon-Aire, Air Filter Products, Series "55" panel filter, tacky side in; or City of Minneapolis approved equal) which shall be held in place by formed angle brackets into which the filter is dropped from above as shown on the drawing labeled "Door Stiffener/Air Filter Bracketing".

The bracket supporting the bottom of the filter shall be 11 inches from the bottom of the door. The upper movable bracket shall be equipped with a piano hinge tack welded to the cabinet door. The bracket shall be able to be rotated 90 degrees on the piano hinge for ease of filter installation and removal. The hinged bracket shall be held in place through use of a tensioning spring attached between the bracket end and a tensioning point on the cabinet door.

The upper and lower supports shall have the inner edges fitted with 3/4-inch wide, 1/4-inch thick bristle type fiber gaskets to insure a tight fit of the filter between the bracket and the door.

To block airflow in cold weather a metal weatherproof cover shall be provided to adequately cover the louvers on the full size door. The cover shall be gasketed and installed from the inside of the cabinet in the filter-mounting bracket, which shall force the louver against the back of the door.

11. Cabinet lifting provisions shall meet the UL requirements for the NEMA 3R cabinet. The lifting provisions shall consist of aluminum lifting ears mounted to extend above the top of the left and right sides of the cabinet enclosure, allowing a bar or hooks to be inserted through both ears for lifting the cabinet.

The lifting ears shall have a lifting capacity equal to the weight of the completely wired cabinet plus 25 percent, 500 pound capacity minimum. Each lifting ear shall have a 1 inch hole, the bottom of which shall be flush with the top of the cabinet or above the top of the cabinet less than 1/8 inch. The top of the lifting ear shall extend no more than four (4) inches above the top of the cabinet at the point where the ear is attached. The lifting ears shall be centered on the cabinet side walls such that the cabinet will not pitch or tilt when lifted. The lifting ears shall be secured to the cabinet by means of corrosion resistant bolts, allowing the ears to be inverted to conserve space during shipping and storage. The positioning of items mounted inside the cabinet shall not restrict access to the bolts.

12. The cabinet shall have termination for incoming 120 volt AC power, grounding and neutral. The cabinet shall have a power surge suppressor and power line conditioner for cleaning stray voltage from the sine wave. Typically, the hub cabinet will receive unconditioned electrical power tapped from a nearby traffic signal. The cabinet shall include one hardwired 6 outlet power strip with internal circuit breaker.
13. One fiber enclosure shall be contained in the cabinet. Each fiber enclosure shall contain all trays and components necessary to terminate 24 single mode fibers and hold 24 single mode fiber splices.
14. Contractor shall provide an electronic pdf file of computer drawn cabinet diagrams showing actual cabinet wiring in a clear, water resistant, plastic pouch.
15. Each cabinet shall have an anodized etched finish (Aluminum Association C22) with an Architectural Class 1 (Aluminum Association A42) hard coat finish of at least 0.7 mil. Finish color shall be 30 minute clear aluminum.

B. CAT-5E Cable

This work shall consist of furnishing and installing a category 5E cable between a traffic signal controller cabinet and a fiber optic hub cabinet. Confirming required actual length is Contractor's responsibility. Cable length shall include approximately 5 feet slack on each end to allow easy cable connection without force on the connectors. Typically, the cable will be connected to an Ethernet switch at each end. The cable shall have RJ-45 connectors installed and attached at both ends. Contractor has option of installing a Cat-5E cable with pre-made connections or making connections upon installation. The Cat-5E cable shall be industrial grade, have sunlight and oil resistant jacketing and be suitable for outdoor and underground applications. The cable shall have a non-gel water block core.

The Contractor shall test all Cat-5E cables installed in the controller cabinet with a tester specifically designed for testing continuity through an RJ-45 connection. The Contractor shall provide a test report – typed or handwritten – for all Cat-5E cables in each cabinet. The test shall state the date of the test, individuals who performed test, identify each cable tested, and state whether the cable passed. All non-passing cables shall be corrected by the Contractor. Furnishing, installing, and testing of Cat-5E cables shall be incidental to the Fiber Optic Hub Cabinet pay item.

C. Payment

Fiber-optic hub cabinets shall be installed as shown in the Plans. The cost of furnishing all materials and labor necessary to perform the work described above shall be paid for as **“Fiber Optic Hub Cabinet”, Each.**



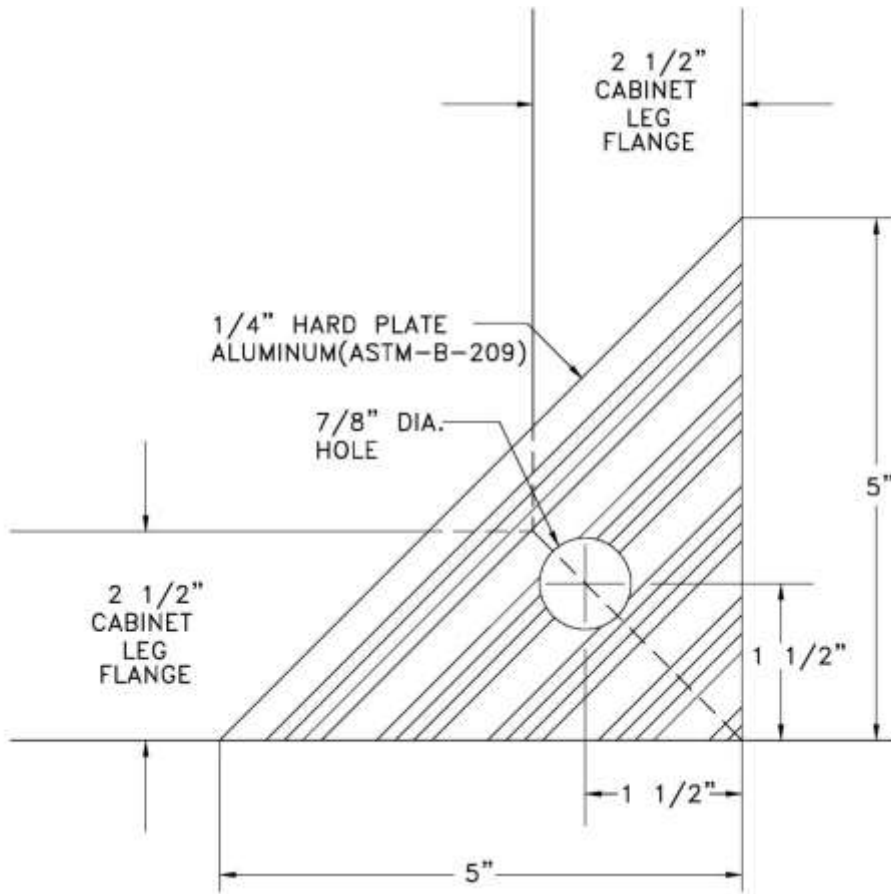

Cabinet Enclosure Corner Brace

**DOOR STIFFENER/AIR FILTER BRACKETING**

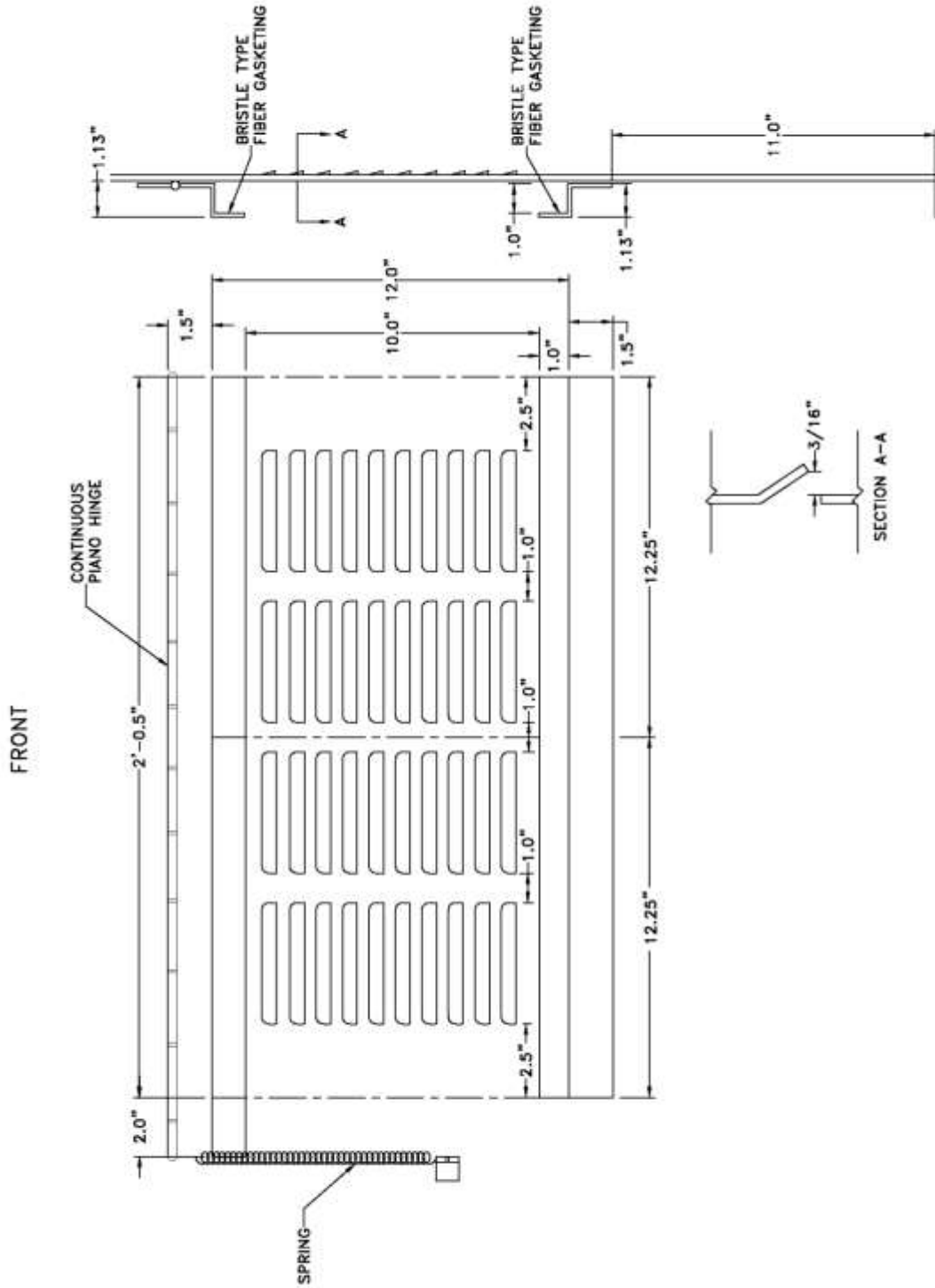

### SS-3.3 Fiber-Optic Hub Cabinet Foundation

This pay item shall consist of installing a traffic signal controller foundation according to Minneapolis Standard Plate No. Traf-1088-R1 Cabinet Foundation, 17" x 33" Fiber Hub Cabinet. Contractor shall reference City standard specifications on concrete for the foundation. The Contractor may, in some cases, be placing the controller foundation over an intercepted conduit. All conduit bends shall be made with preformed conduit bends and elbows. Each foundation shall be constructed with a minimum of three 3-inch NMC conduits. At least one spare unused conduit shall be provided and each spare shall be extended 2-feet beyond the foundation and capped.

All foundation locations shall be approved by the City before construction.

Concrete pad finishing shall be broom finished on all exposed sides, level, and edged with a ½ inch edger. No more than 0.125 inches of variability compensated by shims will be allowed. Variability in excess of this will require resurfacing or replacement at the direction of the Engineer. Inspections will be performed using a Contractor supplied City approved ½" thick steel template manufactured to match cabinet dimensions. The first pad shall be inspected in detail, approved and used as the standard for finish and workmanship. All templates required are incidental to the project.

Concrete for all foundations shall be Mix No. 3Y43 free of chloride additives, placed and consolidated using vibratory equipment and be finished all in accordance with the provisions of MnDOT 2565.3F. Concrete shall be allowed to cure for a minimum of seven (7) days before being placed into use unless otherwise permitted by the Engineer.

Fiber-optic hub cabinet foundations shall be installed as shown in the Plans. The cost of furnishing all materials and labor necessary to perform the work described above shall be paid for as "**Fiber Optic Hub Cabinet Foundation**", Each.

### SS-3.4 Fiber Optic Handholes and Installation

This work shall consist of furnishing and installing fiber optic handholes as shown in the Plans.

New fiber handholes shall be Minneapolis style Fiber Optic Handholes constructed with monolithic HDPC (High Density Polymer Concrete) with cover and box meeting a Tier 22 rating (AUSI/SCTE 77-2007) as shown in the details in the Plans (Minneapolis Standard Plate No. Traf-2710-R2) and shall conform to the City of Minneapolis standards. The handhole shall be of a straight wall design and have an open bottom. A drain field shall be provided with each handhole. Concrete for supporting the ring and cover in non-sidewalk areas shall be Mix No. 3A32 or equal. The design of the handhole shall be such that units are stackable.

Handhole covers shall not be secured with bolts and shall weigh at least 110 pounds. Stainless steel lifting eyes shall be cast into the cover and 5 lifting tools shall be provided at no additional cost with the project. Handhole covers shall be embossed with the label "MPLS

FIBER OPTIC” in 2” high lettering. If bolt holes are present in the cover, suitable plugs shall be provided.

Rings and covers shall be set in a bed of mortar and leveled to the finished surrounding grade. Handhole rings and covers shall be installed such that the lid and ring are flush with surrounding surfaces. This may require that the handhole be installed at an angle in some cases. Handholes shall be supported by an aggregate base and a concrete collar installed in accordance with that shown in Minneapolis Standard Plate No. Traf-2715-R1.

Rings and covers shall be pretreated prior to concrete placement such that the concrete does not adhere to exposed surfaces. Rings and covers shall be cleaned free of adhering concrete after placement.

In some installations, the Contractor will have to excavate around an existing conduit and cut a slot into the vertical panels of the fiber optic handhole to allow the box to fit over the existing conduits. Prior to cutting the slot, the Contractor shall measure the location of the conduit entry point on the handhole wall and, with a hole saw, cut an entry hole into the box wall matching the conduit size. Using a saw, the Contractor shall cut an inverted narrow V slot from the bottom up to the sawed hole.

After the box is satisfactorily prepared, the Contractor shall complete the leveling process on the fiber optic handhole so it is flush with the surface. The gravel under the box shall be tamped firm and the box shall rest firmly on the gravel. All burrs shall be removed from conduits. Conduit ends shall have pre-formed conduit end bells attached.

Once the box is installed over the conduits, the cut out piece fitting the slot shall be epoxied into the wall of the box, filling the hole so that the horizontal conduit enters the box and is a snug fit in the handhole wall. The epoxy shall be one recommended by the manufacturer of the fiber optic handhole box for repairing its boxes. The area surrounding the conduit entrance shall be sealed with a mortar filling. Conduits shall extend a minimum of 1 inch and not more than 2 inches into the handhole.

If the fiber optic handhole installation contains existing cables, the cables shall be neatly ordered in the new handhole. If the handhole intercepts an existing conduit the conduit shall be cut from around the existing cables without damaging the cables.

New conduit runs passing through handholes shall have both entering conduits placed in direct horizontal alignment.

The Contractor shall salvage in place handholes not reused as part of the project unless otherwise directed by the Engineer.

All fiber-optic handholes shall be installed in accordance with the Plans. The costs of furnishing and installing fiber optic handholes including the concrete collars in boulevard areas as described and as shown in the Plans shall be paid for as “**Fiber Optic Handhole,**” **Each.**

## **APPENDIX A - Asbestos Abatement**

## City of Minneapolis

### **ASBESTOS ABATEMENT**

#### **Removal/Replacement of Concrete Pole Bases, Concrete Encased Conduit, and Handholes that Contain Asbestos**

Some Minneapolis signal and streetlight bases, pipes contain asbestos-containing (Transite) electrical conduit which can be broken during the removal and replacement of a streetlight or signal pole foundation. Some Minneapolis style handholes also have asbestos pipe used in the vertical pipe section of the handhole. Asbestos release can be controlled by wetting the concrete base and Transite before and during removal and painting encapsulant on any broken Transite edges exposed during the foundation removal/replacement process.

#### Equipment needed:

- Garden sprayer filled with amended water(water/surfactant mixture – dish washing detergent can be used as a surfactant, use 1 oz./gallon of water)
- Bucket of Childers CP-11 mastic – available at plumbing supply stores
- Disposable paint brush

#### Training needed:

- OSHA requires that workers who disturb asbestos-containing materials must get Class III training. A four-hour session, which includes hands-on training, will meet this OSHA requirement.

#### Procedures:

After the base is excavated, look at the conduit to determine if it is Transite. Transite is a rock hard, gray, slate-like material. Gray PVC pipe was also used as conduit. The PVC pipe requires no special precautions.

When removing wiring, make sure system is completely de-energized. If Transite conduit is present, spray the inside of the conduit and wiring with amended water. Pull the wires out of the conduit. If wires are visibly contaminated, wipe down the wires with disposable wipes.

If the base will be hoisted out of the ground in one piece, paint the exposed Transite conduit with CP-11 and spray amended water inside the conduit. If the base breaks during removal and Transite is exposed, wet the broken areas with amended water. When the base is moved, paint any newly exposed Transite areas with CP-11.

If the base will be broken apart and partially removed, wet the exposed Transite and inside surfaces of conduit with amended water.

When base breaks, immediately spray the newly exposed Transite surfaces with amended water. Paint the exposed Transite surfaces on the removed portion of the base with CP-11.

For the portion which remains in the ground, wet all exposed Transite. It is very important to wet the portion of conduit where any PVC/Steel adapters will be inserted. Carefully set the adapter and paint the Transite and adjacent portions of the adapter with CP-11. Paint any other exposed portions of Transite with CP-11.

Carefully haul removed bases and portions of bases to an area where they can be stored and kept separate from any other concrete which could be recycled.

Asbestos-containing material must not be recycled because crushing this material will release asbestos fibers into the air and also introduce asbestos into the recycled concrete aggregate.

The material which contains Transite conduit must be disposed of at a landfill which accepts asbestos-containing materials. This material can be legally placed in a demolition landfill, but some landfills do not accept asbestos. Call to insure acceptance. Ensure copies of all transite waste haul manifests are provided to City of Minneapolis Traffic.

**APPENDIX B – SAMPLE LOOP DETECTOR TEST REPORT**



**--- S A M P L E ---**

**LOOP DETECTOR TEST REPORT**

STATE PROJECT NO. \_\_\_\_\_

INTERSECTION \_\_\_\_\_

LOCATION I.D. \_\_\_\_\_

No.	Loop Detector Number	Dimensions (in feet)		Number of Turns	Continuity (in Ohms)		Inductance (microhenries)	Insulation Resistance (megohms)	Resonant Frequency (Hertz)
		Length	Width		Loop	Cabinet			

**--- E. T. C. ---**

- NOTES: 1. No. 3, 4, 5, and 6 in the above sample report, are an example of a single loop detector and lead-in cable system.
2. Nos. 1 and 2, in the above sample report, are an example of a multiple loop detector and lead-in cable system.
- The Project Engineer shall distribute the three (3) final loop detector test reports as follows:
- (01) Original report to the official project file
  - (02) Copy to the traffic signal cabinet
  - (03) Copy to the City of Minneapolis

## **DIVISION WM - WATER DISTRIBUTION SYSTEMS SUPPLEMENTAL SPECIFICATIONS**

### **SECTION 1000 GENERAL**

#### **PART 1 - GENERAL**

##### 1.01 Summary

- A. Water Treatment and Distribution Services (WTDS) is authorized by Minnesota Statutes, Chapter 412, other laws, and Minneapolis City code. In accordance with that authority, WTDS hereby promulgates these standards.
- B. Water utility and water service plans shall be developed in conformance with the design criteria specified herein and applicable building codes. Construction shall commence after plan approval has been granted by WTDS, all fees and deposits paid and permits secured after plan approval.
- C. Additions, extensions, and replacement of any water utility or water service shall be designed in accordance with the Minnesota Department of Health, the latest revision of Recommended Standards for Water Works, Great Lakes Upper Mississippi River Board of State Public Health and Environmental Managers. In case of conflicting requirements, the standards set forth herein shall govern.

##### 1.02 PROTECTION OF THE PUBLIC WATER SYSTEM

- A. Under no circumstances shall the Contractor or any other unauthorized personnel perform work on water mains currently in service.
- B. WTDS personnel will operate all water utility valves.
- C. Tampering with public water systems can be a federal offence resulting in prison sentence of up to 20 years, fines, or both. Refer to United States Code Title 42, Chapter 6A, Subchapter XII– Safety of Public Water Systems, Part D, Section 300i–1: “Tampering with public water systems”, the U.S. EPA Safe Drinking Water Act, and the Bioterrorism Act.
- D. Water quality samples shall be taken by WTDS for laboratory analysis and verification of compliance with potable water standards. This requirement applies to all water utility improvement Projects prior to commissioning.
- E. Temporary water main and services may be required to facilitate Project work. All piping and connections shall be supplied, installed, repaired, and removed by WTDS at the expense of the Owner or Contractor.
- F. WTDS will oversee the installation of water main, hydrants, valves, and other water distribution system appurtenances.

### 1.03 COORDINATION AND STAGING OF WORK

- A. Other contractors and City personnel may be working in the vicinity of the Project. The Contractor is responsible for communicating and coordinating with others during the planned work.
- B. Water Utility Shutdown and Temporary Service
  - 1. When water system work requires the shutdown of water mains and the implementation of temporary water supply by WTDS, it is essential the Contractor begin coordination efforts with WTDS immediately upon award of the Contract due to the significant commitment of resources and substantial amount of time needed to perform this work. This initial coordination includes establishing timelines and staging of temporary water supply.
  - 2. The Contractor's coordination with WTDS should also include consideration of location of temporary piping in relation to the scheduling of other components of the project scope (i.e. if temporary piping is to be placed on the sidewalk and sidewalk removals are scheduled while the temporary water supply pipe is in place, problems will result). Therefore, it is in the best interest of the Contractor to communicate early in the project with WTDS regarding the location of temporary water supply piping.
  - 3. Once temporary service has been established, the Contractor shall complete the water utility work, as outlined herein, and deliver on these improvements before the temporary service on that segment of water main is removed and the main is returned to service.
  - 4. The Contractor is responsible for protecting the temporary water pipes and services. Protection shall include necessary heating the temporary water pipe and services to prevent freezing.
  - 5. Temporary water service shall be permitted between the dates of May 1 through October 15.
  - 6. At no time shall temporary water service be commissioned and placed into service prior to May 1 nor extend past October 15, without prior written consent from WTDS
- C. Disinfection, Sampling, and Testing of Water Mains
  - 1. The Contractor shall always be aware that the health and safety of the customers served by WTDS shall always be the first priority of the City of Minneapolis. Adequate advance notification of temporary water and water main disinfection needs and deference to the judgment of the Superintendent of Water Distribution in matters of, and related to, disinfection and sanitary practices involving water main work and the placing into service of water mains shall at all times be required.
  - 2. During flushing operations, the Contractor shall cooperate with WTDS with regard to placement of hoses required to flush sections of water main that have been restored to service. The hoses must remain intact *continuously* until such time that WTDS removes them. Under no circumstances shall the Contractor or any other unauthorized personnel remove flush hoses.

### 1.04 GOVERNING STANDARDS

- A. Products and work quality shall conform to the requirements and standards of the following agencies and organizations, except when more specific requirements are issued as conditions of plan approval or are required by applicable codes. In any case of conflict between the standards and this specification, the requirements of this specification shall govern.

1. Applicable standards (latest version at time of bid) of the American Water Works Association.
2. Recommended Standards for Water Works, commonly called "Ten States Standards," a Report of the Water Supply Committee of the Great Lakes--Upper Mississippi River Board of State and Provincial Public Health and Environmental Managers.
3. Safe Drinking Water Act.
4. Minnesota Plumbing Code.

#### 1.05 DEFINITIONS

- A. The following terms shall have equal meaning: "Water Works", "Minneapolis Water", "Division of Water Treatment and Distribution Services", "Water Division", and "WTDS" all refer to the same subdivision of the Department of Public Works of the City of Minneapolis, Minnesota.
- B. The term "City" refers to any division or department of the City of Minneapolis, a political subdivision of the State of Minnesota.
- C. The term "Engineer" shall henceforth be interpreted as the Superintendent of Water Distribution or representative thereof.
- D. The term "Water Utility" shall be defined as **water main—existing and proposed—and appurtenances as noted herein and within the plan set including gate valves, manholes, hydrants, fittings, and fasteners or other hardware required to perform installation and performance testing.**
- E. The term "Water Services" shall be defined as the piping, fittings, gate valves, and appurtenances necessary to provide water service to individual customers within the service area. Water services are fully owned by the customer from the tapped or fitted connection with the water main to the water meter.
- F. The term "Water Utility Hole" shall be defined as a site excavation necessary for the performance of planned water utility work, by WTDS staff, to facilitate the project. See Detail Plates WATR-3002-R01 and WATR 3003-R01

### **PART 2 - PRODUCTS (NOT USED)**

### **PART 3 - EXECUTION (NOT USED)**

## **SECTION 2000 WATER UTILITY MATERIALS**

### **PART 1 - GENERAL**

#### 1.01 SUMMARY

- A. All materials required for completion of the planned work shall be new manufactured materials conforming to the requirements referenced herein.

- B. Shop drawings or product literature shall be submitted to the Engineer for review and approval of those materials furnished by the Contractor. Approval of the shop drawings shall be received prior to delivery.
- C. Earth materials will be accepted on the basis of the Field and Laboratory testing.
- D. Contractor shall furnish the requisite certificates of compliance for material acceptance as outlined in the Contract documents.

## 1.02 REFERENCES

- A. AWWA C104 – Cement-Mortar Lining for Ductile Iron Pipe and Fittings
- B. AWWA C110 – Ductile Iron and Gray Iron Fittings
- C. AWWA C111 – Rubber Gasket Joints for Ductile Iron Pressure Fittings
- D. AWWA C116 – Protective Fusion Bonded Coatings for the Interior and Exterior Surfaces of Ductile Iron and Gray-Iron Fittings
- E. AWWA C150 – Thickness Design of Ductile Iron Pipe
- F. AWWA C151 – Ductile Iron Pipe, Centrifugally Cast
- G. AWWA C153 – Ductile Iron Compact Fittings
- H. AWWA C509 – Resilient Seated Gate Valves for Water Supply Service
- I. AWWA C515 – Reduced Wall, Resilient-Seated Gate Valves for Water Supply Service
- J. AWWA C550 – Protective Epoxy Interior Coatings for Valves and Hydrants
- K. NSF/ANSI 61 – Drinking Water System Components
- L. ASTM D2000 – Standard Classification System for Rubber Products
- M. ASTM C33 – Standard Specification for Concrete Aggregates
- N. ASTM C150 – Standard Specification for Portland Cement
- O. ASTM A1064 – Standard Specification for Steel Welded Wire Reinforcement, Plain, for Concrete
- P. ASTM C443 – Specification for Joints for Concrete Pipe and Manholes Using Rubber Gaskets
- Q. ASTM C478 – Standard Specification for Circular Precast Reinforced Concrete Manhole Sections
- R. ASTM C497 – Standard Test Methods for Concrete Pipe, Manhole Sections, or Tile
- S. ASTM C990 – Standard Specification for Joints for Concrete Pipe, Manholes, and Precast Box Sections Using Preformed Flexible Joint Sealants
- T. Standard Supplemental Specifications for The Construction of Public Infrastructure in The City of Minneapolis – Current Version
- U. Minnesota Department of Transportation – Standard Specifications for Construction

1.03 QUALITY CONTROL

A. Quality Assurance

1. Manufacturer shall have been in the business of developing and manufacturing the water utility materials specified herein for no less than 10 years.
2. A quality control department shall be maintained by the Manufacturer. Employment of an independent testing agency does not relieve the Manufacturer’s obligation to satisfy the quality control requirements herein.
3. Test results shall be submitted to the Engineer upon request.
4. Materials shall conform to the required dimensions and shall be free from injurious effects.
5. Receipt of cracked, broken, failing or failed, or otherwise defective materials shall be rejected and returned at no cost to the Engineer.
6. Contractor shall use skilled workers who are trained in the requisite capacities for delivery of this Contract along with licensed and calibrated equipment satisfactory to industry and local standards.
7. Contractor shall guarantee satisfactory operation and performance for 1 year.

B. Defect Assessment

1. All materials supplied through the execution of this Contract will be subject to inspection and/or testing by the Engineer upon delivery.
2. Supplied materials deemed unacceptable by the standards set forth herein shall be rejected and reclaimed.

**PART 2 - PRODUCTS**

2.01 Hydrants

A. WTDS will furnish all hydrants.

1. Payment for furnishing hydrants shall be in the form of a check or retainer in advance of hydrant pickup or through an invoice after installation.

B. Private hydrants, when employed, shall be supplied By Others and shall match the design and performance specifications referenced herein.

1. Private hydrants shall be painted yellow.

2.02 DUCTILE IRON PIPE

- A. The pipe shall have an exterior strap or cable for electrical conductivity. The joints shall be in accordance with the latest revision of AWWA C111.
- B. The pipe shall be cement lined in accordance with the latest revision of AWWA C104. The pipe interior shall have a cement mortar lining that is applied and cured in a manufacturing unit contiguous to the casting unit.
- C. The pipe exterior shall be coated with a layer of arc-sprayed zinc per ISO 8179. The mass of the zinc shall be a minimum of 200g/m<sup>2</sup> with a minimum 1-mil thick bituminous material applied to the outside of the pipe by means of an airless spray or other factory approved

method. All linings and coatings in contact with potable water shall be in compliance with the latest revision of ANSI/NSF Standard 61.

#### D. Ductile Iron and Cast Pipe Joints

##### 1. Push-On Joints

- a. The circular rubber gasket shall be flexed inward and inserted in the gasket recess of the bell socket. A thin film of approved gasket lubricant shall be applied to either the inside surface of the gasket or the outside surface of the spigot end, or to both. Care shall be taken while inserting the spigot end to prevent introduction of contaminants. The joint shall be completed by forcing the spigot end to the bottom of the socket by the use of suitable pry-bar or jack type equipment.
- b. Spigot ends which do not have depth marks shall be marked before assembly to insure full insertion. Field cut pipe shall be filed or ground at the spigot end to resemble the manufacturer's fabricated detailing.

##### 2. Mechanical Joints

- a. The last 8" of the outside spigot surface and the inside bell surface of each pipe and appurtenance joint shall be painted with a soap solution, after being thoroughly cleaned. The cast iron gland shall then be slipped on the spigot end with the extension toward the socket or bell end. The rubber gasket shall be painted with soap solution and be placed on the spigot end with thick edge toward the gland. An approved lubricant for potable water provided by the pipe manufacturer may be used in lieu of the soap solution.
  - b. After the spigot end is inserted into the socket to full depth and centered, the gasket shall be pressed into place within the bell evenly around the entire joint. After the gland is positioned behind the gasket, all bolts shall be installed and nuts tightened alternately to the specified torque, such as to produce equal pressure on all parts of the gland.
  - c. Unless otherwise specified, the bolts shall be tightened by means of a suitable torque-limiting wrench to within a foot-pound range of: 40 to 60 for 5/8-inch bolts; 60 to 90 for ¾ inch bolts; 70 to 100 for 1-inch bolts; and 90 to 120 for 1-¼ inch bolts.
3. Flex Ring, Lock Ring, Ball and Socket, Grooved, Segmental or Clam Type, Other Joint Types as approved by Engineer.

#### 2.03 Gate Valves

- A. Ductile iron, resilient-wedge valves rated for 250 psi with a non-rising stem. Gate valves shall be suitable for buried service and shall conform to the latest version of AWWA C509/C515 with the following:
  1. Valves shall be right-hand opening (clockwise).
  2. Stem seals shall be O-ring type.
  3. Mechanical joint valves-ends. Bolt holes shall be equally spaced and shall straddle the centerlines of the flange.
  4. 2-inch square wrench nut shall not be painted red. The word "open" and an arrow shall be cast on the body to indicate direction to open.
  5. Valves utilizing bonded seats shall pass (as defined by AWWA C515) proof of design tests for rubber-metal bond as specified in ATSM D249.

6. Stem and Seal

- a. Stems shall be low zinc bronze, less than 2 percent zinc, with no lead. Stems shall also have two low torque thrust bearings to reduce friction during operation.
- b. Bronze stem with integral thrust collar. Seal shall be two O-rings above thrust collar and at least one O-ring below.
- c. The O-rings above the thrust collar shall be replaceable with the valve fully open and subjected to full rated working pressure.
- d. Stems shall operate with bronze stem nuts, independent of the stem and of the wedge.
- e. Bolts and other hardware to assemble the valve shall be Stainless Steel.
- f. Bolt configuration shall allow the valve to be disassembled without removing it from the pipeline.

7. Finishes

- a. Body, Bonnet, and Stuffing Box shall be fusion bonded epoxy coated, both interior and exterior. Epoxy shall be applied in accordance with AWWA C550 and shall be NSF 61 Certified.

8. Ductile iron wedge shall be symmetrical and fully encapsulated with molded EPDM rubber; no exposed iron.

9. Valve ferrous metal parts shall all be ductile iron.

10. Acceptable gate valves shall be Clow, Mueller Co., M & H, US Pipe Valve and Hydrant, American Flow Control, and Kennedy Valve.

2.04 Fasteners

A. Cor-Blue Bolts

- 1. Manufactured from corrosion-resistant, high-strength, low-alloy steel in accordance with ANSI/AWWA C111/A21.11, that has a baked-on ceramic-filled fluorocarbon resin, which handles the needs of highly corrosive conditions.

B. Stainless steel with hexagonal heads satisfying the strength definition of ASTM A307.

C. Approved Equivalent.

2.05 Fittings

A. Coatings and Linings

- 1. The fittings shall be fusion-bonded epoxy coated on the interior and exterior surfaces or cement-mortared lined on the interior surface and bituminous coated on the exterior surface.
- 2. Materials in contact with potable water shall be certified to the requirements of NSF/ANSI 61. The certifying organization shall be accredited by the American National Standards Institute.

B. Bolt Holes Orientation

- 1. Bolt holes shall be equally spaced and shall straddle the centerlines of the flange.

C. Working Pressures

- 1. Ductile-iron mechanical joint fittings for 3-24 inch size range shall be rated for 350 psi.



- D. Mechanical joints conforming to AWWA C111 shall be used in all buried locations. Flanged fittings may be allowed inside vaults.
- E. Joint restraint shall be accomplished using MEGALUG® Mechanical Joint Restraints, manufactured by EBBA Iron, or equivalent USA-manufactured product.

2.06 Valve Box

- A. Valve boxes shall be cast iron of the three (3) piece type with five and one-fourth inch (5 ¼”) shafts conforming to ASTM A48 standards, screw-type, one and one-half inches (1 ½”) between threads.
- B. Valve boxes shall be Tyler 6860 Series Item G with a stay-put cover. Deep valves may be required to have nut extensions installed for elevation to accommodate the operating key. Bottom nut shall be bolted to valve nut and only one section. Valve boxes shall have at least six-inch adjustment above and below specified depth of pipe with a thirty-six-inch bottom section. Adjustments to be made with Tyler items 58, 59 or 60 extensions of appropriate length.
- C. All valve box assemblies shall include a cast iron lid with the word “WATER” cast into the top.

2.07 Tap Sleeves

- A. Sizes 4” to 12” Diameter
  - 1. Heavy Duty/High Pressure
  - 2. Used with standard mechanical joint resilient wedge gate valves per the latest C509.
  - 3. ¾” stainless steel test plug.
  - 4. Minimum pressure rating shall be 150 psi.
  - 5. NSF 61 certified.
  - 6. Factory hydrostatically tested
  - 7. Required Sleeve Diameter Ranges - Sleeves shall be adaptable to properly fit and seal Class A, B, C, D Pit Cast Iron pipe and Ductile Iron pipe in the following O.D. sizes:

*Table 2.07-1 Tap Sleeve Sizing*

PIPE DIAMETER	TAP SLEEVE DIAMETER
4” pipe	4.8”–5.0”
6” pipe	6.9” –7.10”
8” pipe	9.05” –9.30”
12” pipe	13.20” –13.50”

- B. Sizes 16” and Larger – Engineering Required
- C. Component Materials
  - 1. Sleeve body shall be fabricated completely from Stainless Steel grade 304/316. All welding shall be passivated so as to return the welded stainless steel to its original corrosion resistance. Sleeve shall be two-piece. Outlet shall be a one-piece casting of 304/316 stainless steel welded 360 degrees, with a shoulder and plain end cross sectional profile fully complying to the latest AWWA C153.

2. The inside diameter of the outlet and the branch shall be larger in diameter than nominal to allow the use of a full-size cutter. Lugs fabricated of 304/316 stainless shall be attached by means of continuous weld to the body of the sleeve and shall be designed to prevent the rotation of the head of the drop-in bolts, and facilitate the installation of the sleeve.
3. The tapping sleeve shall have a branch sealing gasket with o-ring design incorporating both hydrostatic and mechanical forces to affect a dynamic seal. Shell gasket shall be a ¼ inch thick complete circle gasket manufacture with 100% new rubber (Nitrile, Buna-N) shall be attached to the sleeve at the factory. Gasket shall have multi sealing ribs. An industry standard mechanical joint gasket complying with AWWA C111 shall be supplied with the sleeve.

D. Fasteners

1. Fasteners for the tapping sleeve shall be Drop-in stainless steel (304/316) track-head bolts and stainless steel heavy Hex nuts with fusion bonded coating. The minimum quantity of drop-in bolts per outlet diameter shall be as follows:

*Table 2.07-2 Fasteners Quantity*

<b>OUTLET DIAMETER</b>	<b>DROP-IN BOLT QUANTITY</b>
3"	8pcs
4"	10pcs
6"	10pcs
8"	16pcs
10"	20pcs
12"	20pcs

- E. Approved manufacturers include EZ Max and Power Seal Pipeline Corporation.

2.08 Repair Sleeves

A. Sizes 4" to 16" Diameter

1. Heavy Duty/High Pressure – Double Band
2. Minimum pressure rating shall be 150 psi.
3. NSF 61 certified.
4. Factory hydrostatically tested
5. Required Sleeve Diameter Ranges – The stainless-steel sleeves shall be adaptable for Class A, B, C, D Pit Cast Iron Pipe and Ductile Iron Pipe in the following O.D. sizes:

*Table 2.08-1 Repair Sleeve Sizing*

<b>PIPE DIAMETER</b>	<b>REPAIR SLEEVE DIAMETER (inches)</b>
4" pipe	4.8–5.0
6" pipe	6.9–7.1
8" pipe	9.05–9.30
12" pipe	13.2–13.50
16" pipe	17.40–17.80

- B. Sizes 24” and Larger – Engineering Required
- C. Component Materials
  - 1. All bands shall be Type 304/316 Stainless Steel. Sleeve lugs shall be high strength Ductile Iron or Stainless Steel. Bolts and hexagon nuts shall be Stainless Steel treated to prevent galling. Sleeve gaskets shall be of resilient material and shall provide sealing across the full pipe circumference and the full area of the band.
- D. Approved manufacturers include EZ Max and Power Seal Pipeline Corporation.

2.09 Water Service Pipe and Fittings

- A. Water service pipe of three (3) inch or larger inside diameter shall conform to the requirements for AWWA C150 and AWWA C153 for ductile iron pipe and fittings and as set forth under the provisions of these specifications.
- B. Water service pipe of two (2) inch or less inside diameter shall conform to the requirements of ASTM B88 for Seamless Copper Water Tube, Type K, Soft temper.
- C. Corporation stops, service saddles, curb stops, and curb stop service boxes shall be constructed as shown in the detail plates. All fittings for copper tubing shall be cast copper alloy conforming to AWWA C800, having uniformity in wall thickness and strength, and shall be free of defects affecting serviceability.
- D. All buried copper pipe fittings shall be flared type.
- E. All threads for underground service line fitting shall conform to the requirements of AWWA C800. Each fitting shall be permanently and plainly marked with the name or trademark of the manufacturer.
- F. All rubber components shall be NSF-61 approved EPDM.
- G. Curb stop service boxes shall be gray iron castings conforming to the Minneapolis pattern and the requirements of ASTM A48 for Class 20 or higher tensile strength.
- H. Taps into water main with less than four full threads shall use a service saddle conforming to AWWA C800.

2.10 Concrete

- A. Concrete shall conform to MnDOT 3G52 – 4,500 PSI design strength.
- B. Concrete conforming to MnDOT 3GHE52 – 4,500 PSI may be used with approval of the Engineer.

2.11 Precast Doghouse Manholes

- A. Manufacture in conformance with ASTM C478 and Detail Plates WATR-3000-R01 and WATR-3001-R01.

2.12 Cast Iron Ring and Covers

- A. The cast iron ring and covers for public water main and private water service manholes shall be constructed in accordance with ASTM A48, Class 35B cast iron or ASTM A536 Grade 65-45-12 ductile iron, and cast according to Detail Plate WATR-3000-R01 and WATR-3001-R01.

2.13 Pitot Taps For Chlorination

- A. Pitot-taps used for chlorination or flushing purposes shall be a 1"x1-1/4" corporation stop as specified:
  - Inlet: AWWA thread.
  - Outlet: Increased size iron pipe thread with inside driving thread.
- B. Brass content shall meet AWWA Specifications C-800.

2.14 Earth Materials

- A. Earth materials provided for foundation, bedding, cover, and backfill, shall be defined in accordance with the following:

*Table 2.14-1 Backfill Zones*

<b>MATERIAL DESIGNATIONS</b>	<b>ZONE DESIGNATION</b>
Foundation	Area beneath bottom of pipe – undisturbed soil unless unsuitable material (organics, rock, etc.) is encountered.
Bedding	Placed below the pipe midpoint, prior to pipe installation, to provide uniform pipe support.
Cover	Placed from pipe centerline to one foot above top of pipe.
Backfill	Placed above Cover elevation to bottom elevation of aggregate base course, if any, as the second stage of backfill, to achieve thorough initial consolidation of foundation for surface improvements.

- 1. In each case above, unless otherwise shown in the Plans, the lower limits shall be the top surface of the next lower course as constructed. The upper limits of each course are established to define variable needs for aggregate gradation and compaction or void content, taking into consideration the sequence of construction and other variables. The material and zone designations described above shall only serve to fulfill the objective and shall not be construed to restrict the use of any particular materials in other zones where gradation requirements are met.

B. Gradation

- 1. Earth materials shall consist of any natural or synthetic mineral aggregate such as sand, gravel, crushed rock, or crushed stone to meet the gradation requirements specified herein for each particular use.

*Table 2.14-2 Earth Materials*

	<b>MATERIAL USE DESCRIPTION</b>			
<b>PERCENT PASSING SIEVE</b>	<b>FOUNDATION MnDOT 3149.2J</b>	<b>BEDDING MnDOT 3149.2G</b>	<b>COVER MnDOT 3149.2G</b>	<b>BACKFILL MnDOT 3149.2E</b>

SIZE				
3 inch	-	-	-	-
2 inch	-	-	-	100
1 inch	-	100	100	-
3/4 inch	-	90-100	90-100	-
3/8 inch	100	50-90	50-90	-
#4	90-100	35-80	35-80	35-100
#10	45-90	20-65	20-65	20-70
#40	5-35	10-35	10-35	10-35
#200	0-3	3-10	3-10	3-10

2. Earth granular materials excavated during the project may be allowed for use with approval of the Engineer.
3. Suitable material shall be defined as classified granular fill, free of foreign materials (rubbish, debris, etc.).
4. Frozen clumps, oversize stone, rock, concrete or bituminous chunks, and other unsuitable materials that may in the opinion of the Engineer promote corrosion of pipe, damage the pipe installation, prevent thorough compaction, or increase the risks of settlement unnecessarily shall not be used.

2.15 Anodes

- A. The anodes shall be of the type and size specified. They shall be commercially cast and pre-packaged. Each anode shall have a full-length core with a #12 AWG or larger insulated copper lead wire attached.
- B. Zinc anodes shall conform to the requirements of ASTM B-418, Type II composition. Unless otherwise specified, the packaged backfill shall be 20-30 percent bentonite and 70-80 percent gypsum.
- C. Magnesium anodes shall have a chemical composition of 5-7 percent aluminum, 2-4 percent zinc, 0.15-0.25 percent manganese, a maximum of 0.7 percent other varied elements, and the balance magnesium. The packaged backfill shall be approximately 75 percent hydrated gypsum, 20 percent bentonite, and 5 percent sodium sulfate.

2.16 Wire

- A. The wire for header cables, anode leads, and joint bridging shall be a single conductor, standard, plain annealed copper with a black, high-molecular weight polyethylene insulation and jacket. The polyethylene shall conform to ASTM Designation D-1248, Type I, Class C, Grade 5.
- B. Wire for header cables and anode leads shall be 12 AWG copper or larger. Wire for bridging joints shall be 6 AWG copper or larger.

2.17 Cathodic Protection Test Station

- A. Flush Mounted.
  1. Tube: Following Standard Details.
  2. Cast iron or high impact plastic collar with ribs.

3. Cast iron or high impact plastic locking lid: Blue with permanent identification marking "WSSC Test Station" to withstand AASHTO H-20 traffic loads and ultraviolet rays.

B. Aboveground

1. Weatherproof enclosure: Cast aluminum, galvanized steel, or high impact plastic, Lexan, Gyrlyn or equal.
2. Test box enclosure with locking waterproof cover: Fasten on pipe using non-rusting materials: stainless steel, galvanized steel, or cadmium plated steel fasteners.
3. Terminal block: Phenolic resin, plastic, micarta, Lexan, or Bakelite high dielectric material, with 7 terminals unless otherwise shown on Drawings.
4. Terminals: Nickel plated brass 1/4-inch threaded studs, nuts, and washers.
5. Shunt: 0.01 ohm with minimum of 6 ampere capacity in test stations with galvanic anodes following Drawings

2.18 Backflow Prevention Device

A. Double Check and Double Check Detector Assembly

1. One piece assembly.
2. Two (2) independently acting, spring loaded check valves with inlet and outlet resilient seated OSY gate valves.
3. Double Detector Checks shall include a minimum 3/4-inch bypass assembly with integral water meter and double check valve.
  - a. Meter will be supplied by WTDS.
4. Design to meet the requirements of ASSE 1048
5. Approved manufactures
  - a. Watts
  - b. Zurn Wilkins
  - c. Approved equivalent

B. Reduced Pressure Principal and Reduced Pressure Principal Fire Protection Assembly

1. One-piece assembly
2. Design to meet the requirements of ASSE 1013.
3. Approved manufactures:
  - a. Watts
  - b. Approved equivalent

**PART 3 - EXECUTION (NOT USED)**

**SECTION 3000 CONSTRUCTION****PART 1 - GENERAL**

## 1.01 SUMMARY

- A. Water utility installation and/or construction shall be performed in accordance with Minneapolis Ordinances, the Recommended Standards for Water Works (Ten States Standards) and all relevant AWWA Standards as required by the Minnesota Department of Health.

**PART 2 - MATERIALS (NOT USED)****PART 3 - EXECUTION**

## 3.01 Pick Up and Delivery of Materials

- A. All delivery and pick up arrangements shall be the Contractor's sole responsibility. The Contractor shall notify the WTDS East Side Yard Warehouse (612-673-5600) at least 24 hours in advance of the time when the materials are required to be picked up.
- B. The WTDS Warehouse will be available for material pickup. Materials shall be picked up at the WTDS Warehouse located at 935 5<sup>th</sup> Avenue SE, Minneapolis.

## 3.02 Line and Grade

- A. The Contractor will establish the primary line and grade unless stated otherwise in the Contract.
- B. The Contractor shall arrange its operations to avoid unnecessary interference with the establishment of the primary line and grade stakes. The Contractor shall bear the full cost of any re-staking necessitated by the Contractor's negligence.
- C. The Contractor shall be solely responsible for the correct transfer of the primary line and grade to all working points and for construction of the work to the prescribed lines and grades as established by the Engineer.
- D. Upon completion of construction, coordinate with WTDS surveyor and inspector to document the installation of new utilities and asset information.

## 3.03 Protection of Surface Structures

- A. All surface structures and features located outside the permissible excavation limits for underground installations, together with those within the construction areas that are shown in the Plans as being saved, shall be properly protected against damage and shall not be disturbed or removed without approval of the Engineer. Within the construction limits, as required, the removal of improvements such as paving, curbing, walks, turf, etc., shall be subject to acceptable replacement after completion of underground work. All expense of removal and replacement shall be borne by the Contractor to the extent that separate compensation is not specifically provided for in the Contract.
- B. Obstructions such as street signs, guard posts, small culverts, and other items of prefabricated construction may be temporarily removed during construction provided that essential service is

maintained in a relocated setting as approved by the Engineer and that non-essential items are properly stored for the duration of construction. Upon completion of the underground work, all such items shall be replaced in their proper setting at the sole expense of the Contractor.

- C. In the event of damage to any surface improvement, either privately or publicly owned, the Contractor shall replace or repair the damaged property to the satisfaction of the Engineer and without cost to the Owner.

#### 3.04 Interference of Underground Structures

- A. When any underground structure interferes with the planned placement of the pipeline or appurtenances to such an extent that alterations in the work are necessary to eliminate the conflict or avoid endangering effects on either the existing or proposed facilities, the Contractor shall immediately notify the Engineer of the affected structure. When any existing facilities are endangered by the Contractor's operations, the Contractor shall cease operations at the site and take such precautions as may be necessary to protect the in-place structures until a decision is made as to how the conflict will be resolved. Operation can continue at other locations where no conflict is found.
- B. Without specific authorization from the Engineer, no essential utility service shall be disrupted, nor shall any change be made in either the existing structures or the planned installations to overcome the interference. Alterations in existing facilities will be allowed only to the extent that service will not be curtailed unavoidably and then only when the encroachment or relocation will satisfy all applicable regulations and conditions.
- C. Whenever alterations are required as a result of unforeseen underground interference's, not due to any fault or negligence of the Contractor, any alterations ordered by the Engineer will be paid for as Extra Work. Any alterations made strictly for the convenience of the Contractor shall be subject to prior approval and shall be at the Contractor's expense. No extra compensation will be made for unavoidable delays caused by the interference of existing underground structures shown in the Plans.

#### 3.05 Concrete Encasement of Water Mains

- A. When any above grade, at grade, or underground structure or facility interferes with the existing or planned placement of the water main or appurtenances to such an extent that alterations to the water main laying line (vertical or horizontal offsets) are necessary to eliminate the conflict or avoid endangering effects on either the existing or proposed facilities, or when it is necessary to offset an existing water main to eliminate a conflict or avoid endangering effects, or when any underground facility would impede the excavation and maintenance of the water main in the future, the water main pipe shall be removed and new pipe shall be installed and concrete encased.
- B. In the event of such findings when or where the proper clearances or setbacks, as outlined herein, cannot be attained, the water main shall be removed, and new pipe shall be installed and concrete encased over the length of watermain defined by the Engineer.
- C. Other conditions where concrete encasement is required:
  1. Potential for stray current
  2. Vertical clearance. Utility crossings where there is not at least eighteen (18) inches of clear distance between the water main and the other facility.



3. Very large or heavy facilities directly over the water main or over the water main but at a horizontal distance away that is not sufficient to allow for access to the water main in the future.
4. Thrust restraining purposes
  - a. The concrete encasement shall extend five feet beyond the edge of the conflicting facility or in the case of a vertical or horizontal offset, 24-inches beyond the bends connecting the offset to the existing pipe or as shown on the approved plans.

### 3.06 TEMPORARY WATER SUPPLY PIPING

- A. All temporary water supply piping required on the project shall be supplied and installed by WTDS prior to taking any section of existing water main out of service. WTDS will make every effort to coordinate temporary piping with the Contractors' work.
- B. WTDS reserves the right to make final determinations with regard to extent and placement of temporary water piping and services.
- C. The amount of time required for planning and implementation of temporary water service varies greatly depending upon the location, type and number of services to receive temporary water, and workload of City forces. As such the Contractor, must make every effort to communicate as early as possible with regard to the desired timing and sequencing of work requiring temporary water service.
- D. The contractor shall be responsible for protecting the temporary piping and services from damage due to its activities or to its negligence.
- E. WTDS will remove the temporary water pipes when the main is ready to be placed back in service. However, the Contractor shall not, under any circumstances, remove any of the temporary water components.

### 3.07 Excavation

- A. Excavation operations shall proceed only as far in advance of pipe laying as will satisfy the needs for coordination of work and permit advance verification of unobstructed line and grade as planned. Where interference with existing structures is possible or in any way indicated, and where necessary to establish elevation or direction for connections to in place structures, the excavating shall be done at those locations in advance of the main operation so actual conditions will be exposed in sufficient time to make adjustments without resorting to Extra Work or unnecessary delay.
- B. The excavating operations shall be conducted so as to carefully expose all in place underground structures without damage. Wherever the excavation extends or approaches so close to an existing structure as to endanger it in any way, precautions and protective measures shall be taken as necessary to preserve the structure and provide temporary support. Hand methods of excavating shall be utilized to probe for and expose such critical or hazardous installations as gas pipes, electric power, and fiber optics or telephone cables.
- C. During the project, if the Contractor encounters any conditions indicating contaminated soil or contaminated water, the Contractor shall immediately stop the work in the vicinity, notify the Engineer, and declare a differing site condition.

### 3.08 Excavation and Disposition of Materials

- A. Excavated materials will be classified for reuse as being either Suitable or Unsuitable for backfill or other specified use, subject to selective controls. All suitable materials shall be reserved for backfill to the extent needed, and any surplus remaining shall be utilized for other construction of the Project as may be specified or ordered by the Engineer or disposed of in accordance with waste disposal regulations. To the extent practicable, granular materials and topsoil shall be segregated from other materials during excavating and stockpiling operations so as to permit the best use of available materials at the time of backfilling.
- B. All excavated materials reserved for backfill or other use on the Project shall be stored at locations approved by the Engineer that will cause a minimum of inconvenience to public travel, adjacent properties, and other special interests. The material shall not be deposited so close to the edges of the excavation as would create hazardous conditions, nor shall any material be placed so as to block access by emergency services.
- C. All material stockpiles shall be located and covered / secured in accordance with the approved Erosion / Sediment Control Plan for the project. All materials considered unsuitable by the Engineer shall be removed from the Project and disposed of in accordance with waste disposal regulations.
- D. The Contractor shall investigate the existing water main depths at and nearby the locations of the planned work prior to mobilization as not all depths are at standard bury depth of 8 feet. WTDS will not pay for any extra excavation and shielding due to this matter.

### 3.09 Excavation Limitations and Requirements

- A. Trench excavating shall be to a depth that will permit preparation of the pipe bed as specified and installation of the pipeline and appurtenances at the prescribed line and grade, except where alterations are specifically authorized. Trench widths shall be sufficient to permit the pipe to be laid and joined properly and the backfill be placed and compacted as specified. Extra width shall be provided as necessary to permit convenient placement of sheathing and shoring and to accommodate placements of appurtenance.
- B. Excavations shall be extended below the bottom of pipe or structure grade as necessary to accommodate required aggregate bedding.

### 3.10 Sheathing and Bracing Excavations

- A. All excavations shall be performed and maintained under the direct supervision of a Competent Person as defined by OSHA in 29 CFR 1926, Subpart P. All excavations shall be sheathed, shored, and braced as will meet all requirements of the applicable safety codes and regulations. Comply with any specific requirements of the Contract and prevent disturbance or settlement of adjacent surface foundations, structures, utilities and other properties.
- B. Any damage to the work under Contract or to adjacent structures or property caused by settlement, water or earth pressures, slides, cave-ins, bracing or through negligence or fault of the Contractor in any manner shall be repaired by the Contractor at their expense and without delay. Should the Contractor fail to repair damages in a timely manner, the City may at its option have the damage repaired and deduct the cost from amounts otherwise owed the Contractor.

- C. The Contractor shall assume full responsibility for proper and adequate placement of sheathing, shoring, and bracing, wherever and to such depths that soil stability may dictate the need for support to prevent displacement. Bracing shall be so arranged as to provide ample working space and so as not to place stress or strain on the in-place structures to any extent that may cause damage.
- D. Sheathing, shoring and bracing materials shall be removed only when and in such manner as will assure adequate protection of the in-place structures and prevent displacement of supported grounds. Sheathing and bracing shall be removed as the backfilling reaches the level of respective support.
- E. All costs of furnishing, placing and removing sheathing, shoring and bracing materials, including the value of materials left in place as required by the Contract, shall be included in the prices bid for pipe installation and will not be compensated for separately. When any sheathing, shoring, or bracing materials are left in place by written order of the Engineer, in the absence of specific requirements of the Contract to do so, payment will be made for those materials as Extra Work, including waste materials resulting from upper cut-off requirements.

### 3.11 Preparation and Maintenance of Pipe Bedding

- A. Pipe bedding shall be prepared for a Type 4 or 5 trench as described in AWWA C150. Foundation preparation and bedding placement shall be conducted as necessary to produce a stable foundation and provide continuous and uniform pipe bearing between bell holes. Final subgrade preparations shall consist of placement and compaction of bedding material, such as to produce a finished grade at the centerline of the pipe that is within 0.03 foot of a straight line between pipe joints and to provide bell-hole excavation at each joint as will permit proper joining of pipe and fittings.
- B. Special / Improved Foundations: In rock foundations and when unsuitable materials are encountered, the undesirable materials shall be removed and suitable material installed. Compaction shall be achieved by means of mechanical compaction equipment as approved by the Engineer.
- C. Engineered Foundation: Where the foundation soil is found to consist of materials that the Engineer considers to be so unstable as to preclude removal and replacement to a reasonable depth to achieve solid support, a suitable foundation shall be constructed as the Engineer directs in the absence of special requirement therefore in the Contract. The Contractor may be required to furnish and drive piling and construct concrete or timber bearing supports or other work as may be directed by the Engineer. Any work so directed by the Engineer will be paid for as Extra Work.
- D. Care shall be taken during final subgrade shaping to prevent any over-excavation. Should any low spots develop, they shall only be filled with approved material, compacted to 100% Standard Proctor Density.
- E. The finished subgrade shall be maintained free of water and shall not be disturbed during pipe lowering operations except as necessary to remove pipe slings. Trench dewatering shall be as outlined in the project's Storm Water Pollution Prevention Plan. Draining trench water into sanitary sewers or combined sewers will not be permitted.
- F. All costs of excavating below grade and placing foundation or bedding aggregate as required shall be included in the bid prices for pipe items to the extent that the need for such work is

indicated in the Contract and the Proposal does not provide for payment therefore under separate Contract Items. Any excavation below grade and any foundation or bedding aggregate required to achieve the foundation and isolating conditions as specified above will be considered to be incidental work and no direct compensation will be made therefore.

### 3.12 Inspection and Handling of Pipe

- A. Proper and adequate implements, tools, and facilities satisfactory to the Engineer shall be provided and used by the Contractor for the safe and convenient prosecution of the work. All pipe, hydrants, valves, and fittings shall be handled carefully and in such manner as will prevent damage to protective coatings and linings; preclude the entrance of foreign materials into the inner areas of the pipe and fittings; and avoid piece to piece contact of parts that may be damaged by jolting.
- B. Before being lowered into laying position, and while the pipes are suspended, the Contractor shall make a thorough visual inspection of each pipe section and of each hydrant, valve and fitting unit to detect cracking and other damage that may need corrective action or be cause for rejection. In addition, other crack revealing methods of inspection (hammer ringing or kerosene coating) shall be employed as directed by the Engineer to check out possible or suspected defects more definitely. The Contractor shall inform the Engineer of any defects discovered and the Engineer will prescribe the required corrective action or rejection.
- C. Immediately before placement, the joint surfaces of bell and spigot pipe and fittings shall be inspected for the presence of foreign matter, coating blisters, rough edges and projections, and any imperfections so detected shall be corrected by cleaning, trimming or repair as needed.

### 3.13 Lowering and Setting of Pipe

- A. Trench excavation and bedding preparations shall proceed ahead of pipe placement as will permit proper placement and joining of the pipe and fittings at the prescribed grade and alignment without unnecessary hindrance. Every precaution shall be taken to prevent foreign materials from entering the pipe while it is being placed and before any length of pipe is lowered into the trench, it should be inspected for damage and the inside of the pipe must be swabbed to remove loose dirt and foreign objects. If mud and trench water have been permitted to stand or flow through the pipe, the inside shall be power washed and scrubbed with a strong chlorine solution. The water main materials shall be carefully lowered into laying position by the use of suitable restraining devices. Under no circumstances shall the pipe be dropped or dumped into the trench.
- B. At the time of pipe placement, the bedding conditions shall be such as to provide uniform and continuous support for the pipe between bell holes. Bell holes shall be excavated as necessary to make the joint connections, but they shall be no larger than is adequate. No pipe material shall be laid in water or when the trench or bedding conditions are otherwise unsuitable or improper.
- C. When placement or handling precautions prove inadequate, in the Engineer's opinion, the Contractor shall provide and install suitable plugs or caps to effectively close the open ends of each pipe section before it is lowered into laying position, and they shall remain so covered until removal is necessary for connection of an adjoining unit.
- D. As each length of bell and spigot pipe is placed in position, the spigot end shall be centered in the bell and the pipe forced home and brought to correct line and grade. The pipe shall be

secured in place with approved backfill material, which shall be thoroughly compacted around the pipe with portable mechanical compaction equipment. The joint areas shall remain exposed and precautions shall be taken to prevent the soil from entering the joint space, until the joint seal is affected.

- E. At all times while pipe laying is in progress or during noon hour and overnight periods, all open ends of the pipeline in the trench shall be closed by watertight plugs or other means approved by the Engineer. If water is present in the trench, the seals shall remain in place until the trench is pumped completely dry.

### 3.14 Aligning and Fitting of Pipe

- A. The cutting of pipe for inserting valves, fittings, or closure pieces shall be done in a neat and workmanlike manner without damage to the pipe and so as to leave a smooth square-cut end. Cast iron and ductile iron pipe shall be cut with approved mechanical cutters. Flame cutting shall not be used under any conditions. All rough edges shall be removed from the cut ends of the pipe and, where rubber gasket joints are used, the outer edge shall be rounded or beveled by grinding or filing to produce a smooth fit.
- B. Whenever it is necessary to deflect the pipe from a straight line either in the vertical or horizontal plane, to avoid obstructions, or produce a long radius curve when permitted, the amount of deflection allowed at each joint shall not exceed the allowable limits for maintaining satisfactory joint seal as given in AWWA C600 for mechanical joints and push-on joints, or as otherwise established in the Contract or approved by the Engineer in the case of caulked joints.
- C. Connection and assembly of joints shall be accomplished during the setting, aligning, and fitting operations in accordance with the provisions of these specifications, to the extent that the jointing requirements will permit.

### 3.15 Blocking and Anchoring of Pipe

- A. All plugs, caps, tees, bends and other thrust points shall be provided with joint restraint as specified herein or as approved by the Engineer.
- B. Thrust Blocks
  1. Soils: Soil type to be used in determining the sizing shall be based upon available soil information, if any, and verified in the field by the Contractor, and shall be subject to review of the Engineer.
  2. Construction: Follow provisions of Section 0300 – 3.05, Concrete Encasement in regard to concrete construction. Concrete thrust blocks shall be poured against firm, undisturbed ground and shall be formed in such a way that the joints can be wrapped with poly so that they will be kept free of concrete and remain accessible for repairs.
    - a. Wood forms shall be removed prior to backfilling. Metal forms which are to be left in place shall be AMICO Stay-Form or approved equal.
  3. Concrete Mix: The concrete mix used in thrust block construction shall be as specified herein.
  4. Hot or Cold Weather placing: Shall be performed in accordance with ACI Specifications 305 and 306.
  5. Concrete Thrust Blocks shall be incorporated into the watermain design at each of the locations listed in Section 3.15.A.

- a. Base Slabs per detail plate WATR-3000-R01 are allowed in lieu of formed and poured Thrust Blocks. See Table 3.15-1 for application.
- b. Concrete Thrust Blocks for watermain 16-inches and larger shall be designed by the certifying Engineer.

*Table 3.15-1 Thrust Blocks*

<b>Pipe Dia.</b>	<b>Thrust Restraint</b>
6-8"	1 Base Slab
12"	2 Base Slabs
16" and larger	By design

### 3.16 CONNECTION AND ASSEMBLY OF JOINTS – DUCTILE IRON PIPE

- A. Where rubber gasketed joints are specified, care shall be taken during the laying and setting of piping materials to ensure that the units being joined have the same nominal dimension of the spigot outside diameter and the socket inside diameter. A special adaptor shall be provided to make the connection when variations in nominal dimension might cause unsatisfactory joint sealing.
- B. Immediately before making the connection, the inside of the bell or socket and the outside surface of the spigot ends shall be thoroughly cleaned to remove oil, grit, excess coating, and other foreign matter. During insertion of spigot ends assure proper centering and insertion to full depth. The joint seal and securing requirements shall be as prescribed below for the applicable pipe and joint type.
- C. Joint Restraint Devices
  1. Contractor shall furnish and install approved joint restraint devices at each fitting or as indicated in the plans.
  2. At a minimum, joint restraint and the number of restrained joints to fully and properly restrain the watermain shall be as prescribed by the Ductile Iron Pipe Research Association.

### 3.17 SERVICES

- A. General
  1. Services shall be designed and constructed in accordance with City of Minneapolis ordinances, permit requirements, and the provisions herein.
    - a. In making connections with water main the tap must not be above the axis of the main, and the service pipe must reach a depth of eight (8) feet below the grade of the street or alley at a point within two feet of said main, and continue at that depth to the line of the street or alley.
    - b. The shut-off cock must have a round and free opening through it when open, sufficiently large to allow for proper connection.
    - c. In all streets which are paved, or which have been ordered paved by the city council, such backfilling shall be made compliant with City of Minneapolis Paving requirements.

- d. All work must be done under the supervision the Engineer.
- B. **Fire Services**
1. Fire Services shall be designed and constructed with an in-line Double Check Detector Assembly.
  2. The Double Check Detector Assembly shall be located in the building's dedicated utility room, immediately after the service is plumbed into the building, and prior to the fire service riser or jockey pump.
  3. The Double Check Detector Assembly may be located in a below grade meter vault as illustrated in Detail Plate WATR-2002-R01. Consult with the Engineer regarding applicability.
- C. **Domestic Services**
1. **2-inch and Smaller**
    - a. Water services sizes 2-inches and smaller shall be of annealed copper as outlined herein.
    - b. Line sizes smaller than 2-inch shall be tapped connections.
    - c. Taps that are 2-inch and larger, will require the Contractor to install a tap sleeve, 4-inch gate valve and valve box. The licensed plumber will be responsible for installing the pipe from the gate valve to the required building connection.
  2. **3-inch and Larger**
    - a. Water services sizes 3 inches are larger shall be of ductile iron materials as outlined herein.
    - b. The pipe and appurtenances shall have rubber gasketed push-on or mechanical joints with joint restraint.
  3. A Minneapolis licensed plumbing contractor must complete all service line connections, reconnections, and cut-offs. This includes new taps and cut-offs necessitated by the Project. The licensed and bonded plumber who will be responsible for all service line-related work will be required to obtain all necessary permits from the City of Minneapolis Utility Connections Inspections office before the service line installation begins.
  4. Unless accounted for within a supplemental agreement between the owner or the project or contractor and the City, all costs for permits and inspection fees required for the work shall be included in the Contractor's bid price. It shall be the sole responsibility of the Bidder to obtain all up-to-date information related to these costs for inclusion in the bid. Contact the City of Minneapolis Utility Connections office for current fees and permit application procedures.
  5. All new taps will be installed within the line of the building it services. Each service line shall be perpendicular orientation from the tap in the street to the wall penetration with the building.
  6. All service lines will be continuous from main to stop box, stop box to meter set. No tees or connections to the service line will be made before the meter set. Any extensions to the service line will be made with permit and permission of Utility Connections Inspections.

7. Any extension to an existing service line shall be made with an inspected mechanical connection. Silver solder connections may be used upon request to and approval by the Utility Connections Inspections' Supervisor.
8. The City of Minneapolis Utility Connections Inspections office, as per City of Minneapolis ordinances and requirements, shall inspect all new service line connections and cut-offs.
9. Restoration, reconnection, and/or extension of a water service that is observed to be constructed of lead or galvanized iron materials is prohibited. The water service shall be replaced in whole from the watermain, to and including the stop box, and/or from the stop box to the meter.
10. The method with which occupied buildings are serviced shall comply with the supplement Site Design Guidance Worksheet. Coordinate with the Engineer.

### 3.18 SETTING VALVES, HYDRANTS, FITTINGS AND SPECIALS

- A. Valves, hydrants, fittings, and specials shall be provided and installed as required by the Plans and these specifications and City Standard Detail Plates. The exact locations and settings shall be as directed by the Engineer, and with each installation shall be accomplished in accordance with the requirements for installation of mainline pipe to the extent applicable. Support blocking, reaction backing, and anchorage devices shall be provided as previously outlined elsewhere herein.

### 3.19 Hydrants

- A. Any/all non-traffic-style hydrants shall be replaced at the expense of the Project. Coordinate hydrant replacement with the Engineer.
- B. Any/all hydrants shall be replaced in concert with any/all proposed hydrant branch gate valve replacements. Coordinate hydrant replacement with the Engineer.
- C. The required hydrant length will vary depending upon the depth of the water main at a location, typically between seven and ten feet. The Contractor is responsible for determining the required hydrant length for each location by means of a field measurement. The Contractor shall request and install the hydrant that meets the required depth without the addition of an extension.
- D. Hydrants shall have a full five-inch diameter valve opening. No portion of the hydrant barrel or post shall have an inside diameter less than seven inches
- E. Hydrants shall be the traffic model with breakable devices for the protection of the barrel, stem, and other parts, designed to break at ground level. The lower barrel material shall be ductile iron, with full body construction. No below-grade flanges.
- F. Each hydrant shall have two steamer connections, each with a nominal opening of four and one-half inches in diameter, and placed 90 degrees apart. Minneapolis standard pattern threads which have an outside diameter of male threads of five and nine-sixteenths inches, with four threads per inch, shall be used. Nozzle cap chains shall be galvanized.
- G. Each hydrant bottom or cup shall have a six-inch mechanical joint connection. The bottom of the base (shoe) shall be flat to facilitate a solid, straight installation of the hydrant faster and easier.



- H. Outlet nipples shall be bronze. Hose cap nut and operating nut shall be standard Minneapolis pattern. Caps shall be cast iron or ductile iron.
- I. The hydrant valve shall be of the compression type, opening against the pressure.
- J. A positively operating non-corrodible drip valve shall be provided and arranged so that it will properly drain the hydrant when closed and prevent any leakage when the valve is fully open. The hydrant shall have drain openings that are not less than five sixteenths inches in diameter in the brass seat ring of the main valve, and not less than seven sixteenths inches in diameter in the barrel.
- K. The stuffing box with two “O” rings shall be accessible for packing and readily removable. The operating nut shall be of bronze or non-corrosive metal. Where the valve rod meets the packing, it shall be bushed with bronze or non-corrosive metal and no leakage shall be permitted under the bushed surface, thereby protecting operating threads from water pressure.
- L. Hydrants shall be opened by turning to the left (counter-clockwise), and shall be marked with an arrow to indicate the direction of opening. The hydrant shall have an internal travel stop nut that prevents over-torquing. Hydrants shall be marked with the name or mark of the manufacturer.
- M. All privately owned hydrants shall be yellow with a long-term coating as recommended by the manufacturer and designed with a plumbing code compliant backflow prevention device.
- N. Jointed barrels along with barrel extensions are prohibited from use.
- O. Approved manufacturers include:
  - 1. Waterous Pacer
  - 2. Mueller
  - 3. Clow

### 3.20 Setting Hydrant

- A. Hydrants shall be installed plumb.
- B. The hydrants shall be connected to the mainline pipe with 6” diameter ductile iron pipe, controlled by an independent gate valve housed inside of a valve box.
- C. Install per Detail Plate WATR-1000-R01.

### 3.21 Setting Valve Boxes

- A. The valve box shall be carefully set over the stem. The top section shall be adjustable for elevation and the base centered over the operating nut. The valve box shall be carefully set and braced to ensure that it remains in a vertical position, centered on the stem during and after backfilling. The top of the valve box shall be flush with the finished grade. Backfilling of the trench shall be done in a manner so as to avoid damage to the valve and valve box.

### 3.22 Setting Manholes

- A. Precast manholes shall be located so the offset manhole opening will provide for operation of the valve nut from the street surface and be in line with steps. The valve shall be centered as closely as possible within the manhole.

- B. An operating hole shall be located on the offset manhole cover and a cone provided for operation of the by-pass valve on 24” and larger valves.

### 3.23 Setting Pitot Taps

- A. Pitot Taps shall be installed on both sides of line gates for pressure testing, flushing, chlorination, and for taking water quality samples. The taps shall be housed inside of the pre-cast manholes required for all gate valves. Taps shall be made within nine inches of the gate valve
- B. Pitot taps shall be furnished and installed with each gate valve. See Detail Plate WATR-3000-R01 and WATR-3001-R01.
- C. Pitot taps are not required on hydrant branch gates and private service gates.
- D. Installation and Permitting:
  1. Contractor to install pitots only when the watermain is offline.
  2. WTDS shall install pitots on live watermain. Coordinate the schedule of events with the Engineer.
  3. A tap permit is not required for pitot installation at line gates.

### 3.24 Setting Specials

- A. Drainage branches, blow-offs, air vents, and other special appurtenances shall be provided and installed as required by the Plans and these specifications.

### 3.25 Placement of Backfill

- A. Backfill in the bedding and cover zones shall be placed in 6-inch lifts, unless greater lifts are allowed by the Engineer.
- B. Backfill above the cover zone shall be placed in 12-inch lifts, unless greater lifts are allowed by the Engineer.
- C. Placement of frozen backfill shall not be allowed. All loose material, rocks, debris, snow shall, etc. shall be removed from the trench prior to placement of backfill.

### 3.26 Compaction

- A. Bedding and Cover Zones: Compaction of materials placed within the pipe bedding and cover zones shall be accomplished with portable mechanical compaction equipment, to achieve thorough consolidation under and around the pipe and avoid damage to the pipe.
- B. Above the Cover Zone: Utilize mechanical means until it meets requirements of MnDOT specification 2105.3F1 “Specified Density Method”. Density shall be 100% Standard Proctor. The use of heavy roller type compaction equipment shall be limited to the safe pipe loading.
- C. Natural Soil at the bottom of excavations shall be compacted with several passes of a vibratory compactor prior to placement of any fill or footings.

### 3.27 Restoration / Repairs

- A. In the absence of specific Contract Items covering restoration items, all necessary restoration work shall be done at the Contractor’s expense, as being part of the work required under the

pipeline installation items. Where separate payment is specifically provided, only that work which is necessitated by the Contract will be compensated for. Any improvement removed or damaged unnecessarily shall be replaced or repaired at the Contractor's expense.

### 3.28 Precast Manholes

- A. All line gate valves shall be housed inside precast manholes per City of Minneapolis Standard Detail Plate for Typical Water Manholes.
- B. Manholes shall rest on concrete slabs that act as footings to insure against settlement. Slabs shall be per Standard Detail Plates.
- C. Before the manhole top is installed the Contractor shall place granular fill material in the manhole to a point halfway up the water main to support the main and gate.
- D. Locations requiring special manholes shall be indicated in the plans, and a detail shall be provided in the plan set.

### 3.29 Gate Stem Operating Rods

- A. The Contractor shall install all gate stem operating rods for new or relocated gates. WTDS will provide gate stem operating rods. Contractor shall allow one week for fabrication of rods.

### 3.30 Stop Box Relocations

- A. The Contractor is required to get a permit at the Utility Connections Office in Room 224 of the Public Service Center (250 South 4<sup>th</sup> St.), prior to relocating any stop boxes. The new stop boxes shall be relocated in the boulevard or sidewalk behind the new curb. (A "stop box adjust" refers to adjustment of the elevation of the stop box to suit the new grade only. If the improvements to the right of way place the stop box outside of the allowable area described above, the stop box must be relocated.)
- B. Relocation of stop boxes on service lines which are constructed of lead materials shall be replaced. Dependent upon where the lead materials are observed, the service shall be replaced in full from the watermain to, and including the stop box, and/or from the stop box to the meter. Consult with Engineer in the event a lead service line is encountered.

### 3.31 Relocated Hydrants

- A. The Contractor shall use new hydrants for all hydrant relocations. WTDS may determine the existing hydrant shall be salvaged and reused.

### 3.32 Disinfection of Water Mains

- A. Any construction work done on existing water mains, which may include cuts, plugs, valves or other fittings, and all newly installed water main, shall be disinfected and flushed by WTDS personnel, and the water sampled and tested by the WTDS Water Quality Laboratory. The samples shall be confirmed to be free of coliform organisms prior to the water main being put back in service. It may be necessary to add Pitot taps to the existing water main to flush and bleed the air from the main. Also, with an existing water main out of service it may be necessary to provide temporary service to the Minneapolis customers.

### 3.33 Water Quality Samples

- A. Water quality samples shall be taken by WTDS staff as directed by the Engineer, after cutting and plugging an existing main or before putting a new section of water main into service. If any sample turns out positive, the City shall resample or re-chlorinate that section of water main as necessary until the main is free of all coliform bacteria and meets WTDS Quality Standards. Required re-chlorination, flushing, sampling, etc. needed on mains that the Contractor installed shall be at the Contractors' expense. Required re-chlorination, flushing, sampling, etc. on mains rehabilitated by the City shall be done at its own expense.

### 3.34 Performance Testing

- A. The Contractor shall not conduct any pressure tests against any valve currently installed in the system. Installations made where a new section of pipe connects to an existing valve, the Contractor must install a plug with a pitot tap attached, as close to the valve as possible on the new section of pipe, and any pressure test must be taken against this plug. All temporary plugs, pitot taps and other materials installed or used for hydrostatic testing purposes only, shall be considered an incidental cost for water main work.
- B. After the installation and partial backfill of the water main, leaving the joints exposed for examination, each valve section shall be subjected to the pressure test prescribed herein. The Contractor shall furnish the pump, pipe connections, gauges, and measuring equipment, and shall perform the testing under the direct supervision of the WTDS Engineer. Where permanent air vents are not provided, the Contractor shall provide and install pitot taps as directed by the WTDS Engineer for release of air as the line is filled with water.
- C. Where concrete reaction blocking is placed, the water main shall not be subjected to hydrostatic pressure until at least five days have elapsed after the concrete casting, with the exception that this period may be reduced to two days where high early strength concrete is used.
- D. The section being tested shall be slowly filled with water and the specified test pressure shall be applied after all air has been expelled from the pipe. A hydrostatic pressure of not less than 150 pounds per square inch shall be applied by means of a pump connected to the pipe in a satisfactory manner.
- E. The specified pressure shall be held for a minimum duration of two hours, during which time all exposed pipe, fittings, valves, hydrants, and joints shall be carefully examined for visible leaks. Any defects discovered shall be corrected satisfactorily and the tests repeated until there is less than a 3-psi pressure loss for the two-hour duration.

### 3.35 Concrete Encasement

- A. Reinforced concrete encasements shall be installed in strict accordance to City of Minneapolis Standard Detail Plates for the relevant water main pipe diameter(s).
  - 1. Concrete Mix: As specified herein
  - 2. Formwork: Forms shall be adequately braced and selected to withstand forces placed upon it by the poured concrete and maintain true dimensions of the encasement. All formwork shall be removed prior to backfilling, unless a leave-in-place type form system, approved by the Engineer, is used.

3. Reinforcing Steel: Reinforcing steel shall be installed in accordance with all ACI standards and tolerances by qualified ironworkers.
4. Placement and finishing: Shall be done by personnel experienced in placing and finishing concrete and shall be done in accordance with ACI standards. All blocking and other support mechanisms used to support the water main shall be removed prior to encasement.
5. Cure time: Minimum cure time of concrete before backfilling and compaction shall be 72 hours. Cure time may be reduced if it can be demonstrated that the concrete has achieved a least 65% of the design strength through laboratory analyses. At no time shall backfilling be permitted within the first 24-hours.
6. Cold Joints: Cold joints in concrete encasements shall be allowed only with pre-approval of the Engineer. Contractor shall submit for approval a written plan and/or sketches showing proposed cold joint construction, to include
  - a. Keyed construction at the cold joint(s).
  - b. Properly dimensioned lap splices for rebar at the cold joints.
  - c. Provision of neat cement slurry on cured concrete to act as bonding agent, brush applied just prior to pouring new abutting concrete.
  - d. 3 days' time shall elapse between adjacent pours.
7. Cold Weather Placement: Comply with provisions of ACI 306.
  - a. Concrete shall not be placed against any frozen substrate, including subgrade soils and surfaces of formwork.
  - b. Concrete shall not be placed around any embedment, including reinforcing steel that is at a temperature below freezing.
  - c. Concrete shall be delivered at the following temperatures:
 

<u>Air Temperature</u>	<u>Min. Concrete Temperature</u>
Above 30 Degrees F	60 Degrees F
0 to 30 Degrees F	65 Degrees F
Below 0 Degrees F	70 Degrees F
  - d. Cure the entire surface and edges as soon as surface conditions permit after the finishing operations.
  - e. Maintain concrete temperatures between 50 and 70 degrees for minimum of 72 hours. Engineer may require Contractor to provide method of verification of temperature. Provide means of maintaining moist cure conditions during temperature protection.
  - f. Provide method for protection of concrete from exhaust gasses from combustion heaters, if used, for first 24 hours.
  - g. Provide gradual removal of heat from concrete at conclusion of heating period.
8. Hot Weather Placement
  - a. Comply with ACI 305 when hot weather conditions exist.
  - b. Maintain concrete temperature at time of placement below 90 degrees F.
  - c. Provide required extra measures to protect all surfaces from rapid drying.

## 3.36 Metering

- A. All meters shall be set at the nearest practicable location to the point where the service pipe enters the building; and shall be set in such a manner as to be easily accessible for reading, removal and resetting.
- B. No plumbing device or plumbing fixture or any fitting that would allow non-metered water use shall be installed between the shut off cock and the water meter. No service pipe within a building ahead of a water meter shall be concealed, except that it may be run a reasonable distance beneath the lowest floor in the building.
- C. See Detail Plate WATR-6000-R01, 6001-R01, 6002-R01 and 6003-R01 for meter set illustrations.
- D. Contractor shall designate a space at grade level for the meter transmitting unit.

**SECTION 0400 MEASUREMENT AND PAYMENT****PART 1 - GENERAL**

## 1.01 SUMMARY

- A. All items will be measured separately according to design designation as indicated in the Pay Item name and as may be detailed and defined in the Contract. Pipe will generally be designated by size (inside diameter or span), strength class, kind or type, and laying condition. Items with an "each" or "lump sum" method of measurement as well as items specified as "complete-in-place" shall include all component parts thereof as described or required to complete the unit, but excluding any excess covered by separate Pay Items. Linear measurement of piping will include the running length of any special fittings (tees, wyes, bends, gates, etc.) installed within the line of measurement between specified terminal points.
- B. It is the Bidder's responsibility to assure that any brand being quoted will be able to meet the requirement of the Drawings and Specifications at the price quoted. Prices shall be for furnishing and installing the equipment, complete and ready for operation, in accordance with the Plans and Specifications

**PART 2 - PRODUCTS (NOT USED)****PART 3 - EXECUTION**

## 3.01 Watermain and Water Service

- A. Watermain and Water Service pipe of each kind and size will be measured separately by the overall length along the axis of the pipeline, from beginning to end of each installation and without regard to intervening valves or specials. Terminal points of measurement will be the spigot or cut end, base of hub or bell end, center of valves or hydrants, intersecting centers of tee or wye service connections, and center of corporation stop or curb stop couplings.
- B. Payment for Watermain and Water Service pipe shall be compensated at the appropriate Contract prices per linear foot. Payment shall be compensation in full for all costs of furnishing

and installing the pipe complete in place as specified, with the exception of pipeline appurtenant items, but including all costs of pipe installation and surface restoration as may not be specifically covered under other Contract Items. All costs of pipeline disinfection, performance testing, pipe jointing materials, dead end plugs and caps, making connections to existing facilities, blocking and restraint materials, and other work necessary for proper installation of pipe as specified shall be included for payment as part of the pipe item, without any additional compensation being made therefore.

### 3.02 Valves

- A. Valves shall be furnished and installed by the Contractor and shall be measured on an “each” basis.

### 3.03 Curb Stops

- A. Curb stops of each size and type will be measured separately by the number of units installed, including the required curb box.

### 3.04 Hydrants

- A. New hydrants shall be furnished by WTDS.
- B. Hydrants will be measured by the number of complete units (hydrant, thrust reinforcement, and backfill) installed per specifications and details.

### 3.05 Rearrangement of In-Place Facilities

- A. Relocating, moving, lowering, adjusting, salvaging, installing or removing of in place facilities such as hydrants, valves, curb stops, pipe, etc., will be measured, as indicated in the Contract, by the number of complete units of each item on a per each or lump sum basis, or by the number of linear feet of each item such as pipe rearranged, as per the pay item description.
- B. No separate measurement will be made of the various hardware, fittings or new materials that may be required to complete work identified as relocate, move, lower, adjust or install. Any hardware or fittings necessary to complete the work shall be incidental to the associated Contract pay items.
- C. Unless otherwise provided, no separate measurement will be made for new six (6) inch ductile iron pipe necessary to connect relocated hydrants to the mains as required by the Contract.
- D. When so described in the pay item, hydrants and associated valves shall be measured as one complete unit.
- E. Excavation and Backfill shall be included as part of the bid item for which the excavation is being done (gate valve, piping, and hydrant, for example).

### 3.06 Fittings

- A. Fittings will be measured by the pound without joint accessories and shall be the standard weight of fittings for the specified pressure rating as published in AWWA C110 and/or AWWA C153.

### 3.07 Bedding Materials

- A. No direct payment will be made for furnishing and installing granular backfill and bedding materials (except for Rock Bedding, which will only be used when directed to do so by the Engineer). All granular backfill and bedding materials (except for Rock Bedding) shall be furnished and installed as an incidental cost to the water main installation. Rock Bedding will be used only when directed for use by the Engineer. Rock Bedding (CV) will be measured for payment by the cubic yard, compacted volume (CV), as determined by cross-section method of the material in its placed and compacted position, according to the placement dimensions shown in the Plan or as designated by the Engineer.

### 3.08 Contaminated Soils

- A. Where provisions are not provided for in the project plans and specifications for excavation, handling, re-use, and disposal of contaminated soils, Contractor shall adhere to the provisions of the Minnesota Pollution Control Agency's Guidance Document 5-01 – Managing Petroleum Contaminated Soil at Public Works Projects.
- B. Contractor shall refer to any project specific Corrective/Remedial Action Plan when planned excavations are within known areas of contamination or adjacent thereto.

### 3.09 Water Utility Hole and Access Hole

- A. Quantified as each, to include:
  1. Planning and Location, including "One Call" and safety preparations.
  2. Shoring (whether using corrugated metal cans or wood sheeting).
  3. Excavation as necessary and to properly expose the pipe.
  4. Backfill and compaction.
- B. Access holes required for City-Installed gate valves shall be considered the same as for cleaning access holes and will be measured and paid for as the same.
- C. The trench excavation shall be from the top of the finished grade to the water main. The trench width shall be a minimum 8 feet and the length shall be a minimum 10 feet. Depth to water main will vary and is not guaranteed to be 8' deep. The Contractor shall determine and provide the number of shields needed to create an OSHA approved accessible excavation.
- D. Water Utility Hole and Access shall be paid for by "each". Water Utility Hole and Access shall be paid for by "each". Measurement will be by the number of shielded excavations installed complete. Payment will be under Item 2504.602 (Water Utility Hole) at the Contract bid price per each, which shall be compensation in full for all work included under this section.

### 3.10 Cut Off Service

- A. Cut off service (otherwise referred to as "disconnect service") shall be measured as an "each" quantity on a "per service" basis. All work necessary to accomplish the task shall be considered part of this quantity, including but not limited to:
  1. Permitting, planning, and locating (one-call)
  2. Excavation and shoring
  3. Excavation



#### 4. Backfill

- B. Cutting off a service line at the main shall be considered incidental in the case where a new service line for the same property is being installed in the same hole as the cut-off.

#### 3.11 Removal of Structures and Appurtenances

- A. Removal of Manholes, hydrants, gate valves, etc. shall be measured and paid for per each.

#### 3.12 Furnish and Installation Of Appurtenances

- A. Payment for furnishing and installing valves, corporation stops, curb stops, hydrants, air vents, and other specially identified appurtenant items, at the appropriate Contract prices per each, shall be compensation in full for all costs of furnishing and installing the specified item complete in place as specified, and detailed in the Contract, including final elevation adjustments as necessary. The Contract unit price shall include all costs of furnishing and installing or constructing the required access structures for valves, vents, and specials, which are not to be paid for separately. Access structures such as valve boxes, service boxes, manholes, and vaults will be paid for as separate items only when and to the extent that the Contract contains separate items therefore. When the Contract does not contain a separate pay item for six-inch ductile iron pipe, all such pipe required to connect the new hydrant to the water main shall be furnished and installed as an incidental cost to the hydrant.

#### 3.13 Relocate Curb Stop

- A. Payment for relocation or moving in place curb stops, along with all associated access boxes at the appropriate Contract prices per each shall be compensation in full for all costs of performing the relocation as specified and detailed in the Contract, including final elevation adjustments as necessary. The Contract unit price shall include, but not limited to the following:
  1. Furnishing and installing new pipe and fittings of the same kind and size as the existing components as necessary when the relocation cannot be completed with the existing components.
  2. Furnishing and installing new pipe and fittings of the same kind and size as the existing components as necessary to provide continuous piping in any gaps resulting from the relocation.
  3. Furnishing and installing caps and plugs as necessary when items are permanently removed.

#### 3.14 Adjustment of Water Structures

- A. Payment for adjusting in place hydrants, valve boxes, and curb stop boxes at the appropriate Contract prices per each shall be compensation in full for all costs of adjusting the specified item to the required elevation, without changing the elevation of the actual valve or associated water supply line. The Contract unit price shall include, but not be limited to, furnishing and installing new materials of the same kind and type as the existing components as necessary when the required adjustments cannot be made using the existing materials.

#### 3.15 Installation of Salvaged Items

- A. Payment for the installation of salvaged (or otherwise furnished by others as specified) water main piping or other system components as specified at the appropriate Contract prices per

defined unit of measure shall be compensation in full for all costs of installing the specified item complete in place as specified and detailed in the Contract, including final elevation adjustments as necessary. The Contract unit price shall include, but not be limited to, furnishing and installing replacement bolts, glands, rods, gaskets, and other miscellaneous hardware as may be required to complete the installation.

### 3.16 Salvaged Items

- A. Payment for removing or salvaging water main piping or other system components as specified shall be in accordance with the provisions of MnDOT 2104. The Contract unit price for salvaged items shall include, but not be limited to, furnishing and installing a suitable plug or valve on the end of the existing line remaining so that it can be returned to service when construction activities are performed.

### 3.17 Fittings

- A. Payment for water main fittings of cast or ductile iron at the Contract price per pound, as specified in WM-3.1.7 hereof, shall be compensation in full for all costs of furnishing and installing the iron water main fittings as required. The Contract price per pound shall include the costs for all necessary glands, gaskets, rods, bolts or other accessories as necessary.

### 3.18 Backfill

- A. No direct payment will be made for furnishing and installing granular backfill and bedding materials (except for Rock Bedding, which will only be used when directed to do so by the Engineer). All granular backfill and bedding materials (except for Rock Bedding) shall be furnished and installed as an incidental cost to the water main installation. Payment for Rock Bedding (CV) at the Contract price per cubic yard, compacted volume (CV), shall be compensation in full for furnishing and placing the material as directed by the Engineer.

### 3.19 Connect to Existing Water Main

- A. Connect to Existing Water main shall be measured per each connection of water main pipe to existing water main where shown in the plans. In the case of installation of tees, gate valves, or other fittings on an existing line, it shall be understood that this will be measured as one "connect to existing water main".

### 3.20 Connect / Reconnect Water Service

- A. Payment for Connecting Water Service and Reconnecting Water Service at the Contract bid price per each shall be compensation in full for furnishing and installing materials (except the service pipe, which is paid for separately) and all work necessary to connect or reconnect each service to the new main.

### 3.21 Construct Water Manhole

- A. Payment for Construct Water Manhole shall be compensation in full for furnishing and installing the structure and all associated components as shown in the plan details including, but not limited to, the structure and structure base, casting and rings, and excavating, backfilling, and compacting as needed to complete the installation.

### 3.22 Concrete Encasement

- A. Concrete encasement shall be paid for by the lineal foot for each size (nominal inside diameter) of pipe encased. Payment shall be compensation in full for furnishing all materials and qualified labor to excavate, form, pour, remove forms, backfill, and all other items necessary to complete the encasement. Extra compensation for encasing pipe sections (proposed or existing) that are described in the plan to contain bends shall not be made.

### 3.23 Other Miscellaneous

- A. Unless its existence is shown in the Plans, and other provisions provided for payment, the removal of ledge rock or rocks larger than ½ cubic yard in volume from the excavation shall be paid for as Extra Work.
- B. All costs of excavating to foundation grade, preparing the foundation, placing and compacting backfill materials, restoring surface improvements, and other work necessary for prosecution and completion of the work as specified, shall be included for payment as part of the appropriate pipe and pipe appurtenance items without any direct compensation being made therefore.
- C. All costs of disinfecting and performing the required electrical conductivity, pressure tests on all piping and appurtenances installed in the completion of the work shall be incidental to the Contract water main pay items provided, and no direct payment shall be made therefore.
- D. No payment will be made for the use of steel plates for covering trenches or for providing temporary water service to all users as may be necessary to complete the work.
- E. In the absence of special payment provisions, all costs of repairing, replacing, or otherwise restoring surface improvements as required by the Contract shall be included for payment as part of other Contract items without any direct compensation being made therefore.

**END OF DIVISION WM - WATER MAIN**

**APPENDIX A - SAMPLE OF TRAFFIC CONTROL LOG**

**LONG TERM TRAFFIC CONTROL**

**TRAFFIC CONTROL DEVICES LOG**

S.P. \_\_\_\_\_

		Yes	No	If Yes, Number
1.	A. Any devices missing?	( )	( )	( )
	B. Any devices need repair?	( )	( )	( )
	C. Were they all repaired or replaced?	( )	( )	-----
2.	A. Any lights (flashers, etc.) not working?	( )	( )	( )
	B. Were they all repaired or replaced?	( )	( )	-----
3.	A. Any devices improperly placed?	( )	( )	( )
	B. Were they all corrected?	( )	( )	-----
4.	A. Any devices in need of cleaning?	( )	( )	( )
	B. Were they all cleaned?	( )	( )	-----
5.	A. Any changes to the traffic control layout, to the staging or to temporary lane closures either installed or in place?	( )	( )	-----
	B. If "yes" to 5A, identify location, date and time.	_____		

Action to be taken to correct any deficiencies indicated above:

\_\_\_\_\_  
\_\_\_\_\_

I HEREBY CERTIFY THAT THE ABOVE CHECK WAS COMPLETED BY ME ON:

\_\_\_\_\_ at \_\_\_\_\_  
(Date) (Time)

\_\_\_\_\_ \_\_\_\_\_  
(Signature) (Title)

The Contractor shall inspect, on a daily basis, all the traffic control devices, which the Contractor has furnished and installed, and verify that the devices are placed in accordance with the Traffic Control Layouts, these Special Provisions, and/or the MMUTCD. Any discrepancy between the placement and the required placement shall be immediately corrected. The person performing this inspection shall be required to make a daily log. This log shall also include the date and time any changes in the stages, phases or portions thereof go into effect. The log shall identify the location and verify that the devices are placed as directed or corrected in accordance with the Plan. All entries in the log shall include the date and time of the entry and be signed by the person making the inspection. Copies of the "Traffic Control Devices Log" will be provided at the Pre-Construction Conference. The completed log shall be submitted each working day to the Project Engineer or Project Inspector.

## **APPENDIX B - MPCA STORMWATER GUIDANCE**

**EROSION AND SEDIMENT CONTROL for projects in the Right-of-Way or on City property, including streets and sidewalks, bridges, trails, buildings (examples are police stations, parking ramps, park buildings), parking lots, open spaces (such as parks, plazas), and utilities (traffic lights, watermains, sanitary sewers, stormwater management facilities.** (Reference: *Minneapolis Stormwater Management Program, September 2011, SMP No. 4.2.*)

**A. Where land disturbance is one or more acres:**

- MPCA NPDES General Construction Permit is required, to implement and maintain practices to prevent sediment from entering curb and gutter systems, storm sewer inlets and ultimately surface waters. Prepare SWPPP and apply for and comply with MPCA NPDES General Construction Permit. Provide copy of application to City of Minneapolis Public Works, Surface Water & Sewers Division, c/o of Lois Eberhart, Water Resources Administrator, 309 S 2nd Avenue, Mpls MN 55401 or [lois.eberhart@minneapolismn.gov](mailto:lois.eberhart@minneapolismn.gov)
- Maintain files containing SWPPP, inspection reports and maintenance reports.
- Promptly remove soil or debris that is tracked or otherwise deposited onto right-of-way and/or into storm drains resulting from the construction activity or during transit to and from the construction site.
- Provide management of erosion and sediment control compliance for the life of the project, including inspection and repair of erosion and sediment control devices, proper disposal of wastes at the construction site (concrete truck washout, sawcutting slurry, discarded materials, construction site chemicals, litter and other), and establishment of vegetative cover.
- If dewatering, and if dewatering discharge is sediment laden, create a temporary or permanent sedimentation basin or other sedimentation control measure, so that receiving waters are not adversely affected. The discharge must not cause erosion and scour.

**B. Where land disturbance is less than one acre:**

- For projects on PRIVATE PROPERTY, a City of Minneapolis Erosion Control Permit is required for any land disturbance activity in excess of 500 square feet (or 5 cubic yards). <http://www.ci.minneapolis.mn.us/mdr/soil/index.htm>
- For projects in the Right-of-Way or on City property, no permit is required, however City or MPRB point of contact for the project must require that the project implements and maintains practices to prevent sediment from entering curb and gutter systems, storm sewer inlets and ultimately surface waters, in accordance with this Appendix B.
- Maintain files containing inspection reports and maintenance reports.
- Promptly remove soil or debris that is tracked or otherwise deposited onto right-of-way and/or into storm drains resulting from the construction activity or during transit to and from the construction site.
- Provide management of erosion and sediment control compliance for the life of the project, including inspection and repair of erosion and sediment control devices, proper disposal of wastes at the construction site (concrete truck washout, sawcutting slurry, discarded materials, construction site chemicals, litter and other), and establishment of vegetative cover.
- If dewatering, and if dewatering discharge is sediment laden, create a temporary or permanent sedimentation basin or other sedimentation control measure, so that receiving waters are not adversely affected. The discharge must not cause erosion and scour.

**Targeted Pollutants and Targeted Activities**

**Pollutants**

- |                                  |                              |
|----------------------------------|------------------------------|
| ▪ Phosphorus and other nutrients | ▪ Bacteria                   |
| ▪ Oil and grease                 | ▪ Metals                     |
| ▪ Sediment and other solids      | ▪ Volatile organic compounds |
| ▪ Chlorides and cyanide          |                              |

**Activities**

- |  |                     |
|--|---------------------|
| ▪ Soil erosion   | ▪ Litter            |
| ▪ Concrete truck washout, concrete slurry                                | ▪ Paints and stains |
| ▪ Improper handling and disposal of construction materials and chemicals | ▪ Sanitary waste    |

**The following MPCA guidance sheets are included in this Appendix B are helpful whether or not the project is subject to an NPDES Permit from the MPCA.**

B-1: Stormwater Compliance Assistance Toolkit for Small Construction Operators

B-2: Stormwater Pollution Prevention Plan (SWPPP)

B-3: Construction Stormwater Permit Training Requirements

B-4: Linear Utility Projects

B-5: Emergency Construction Stormwater Application

B-6: Concrete Washout

B-7: Perimeter Control

B-8: Site Stabilization

B-9: Stormwater Inlet Protection

B-10: Vehicle Tracking



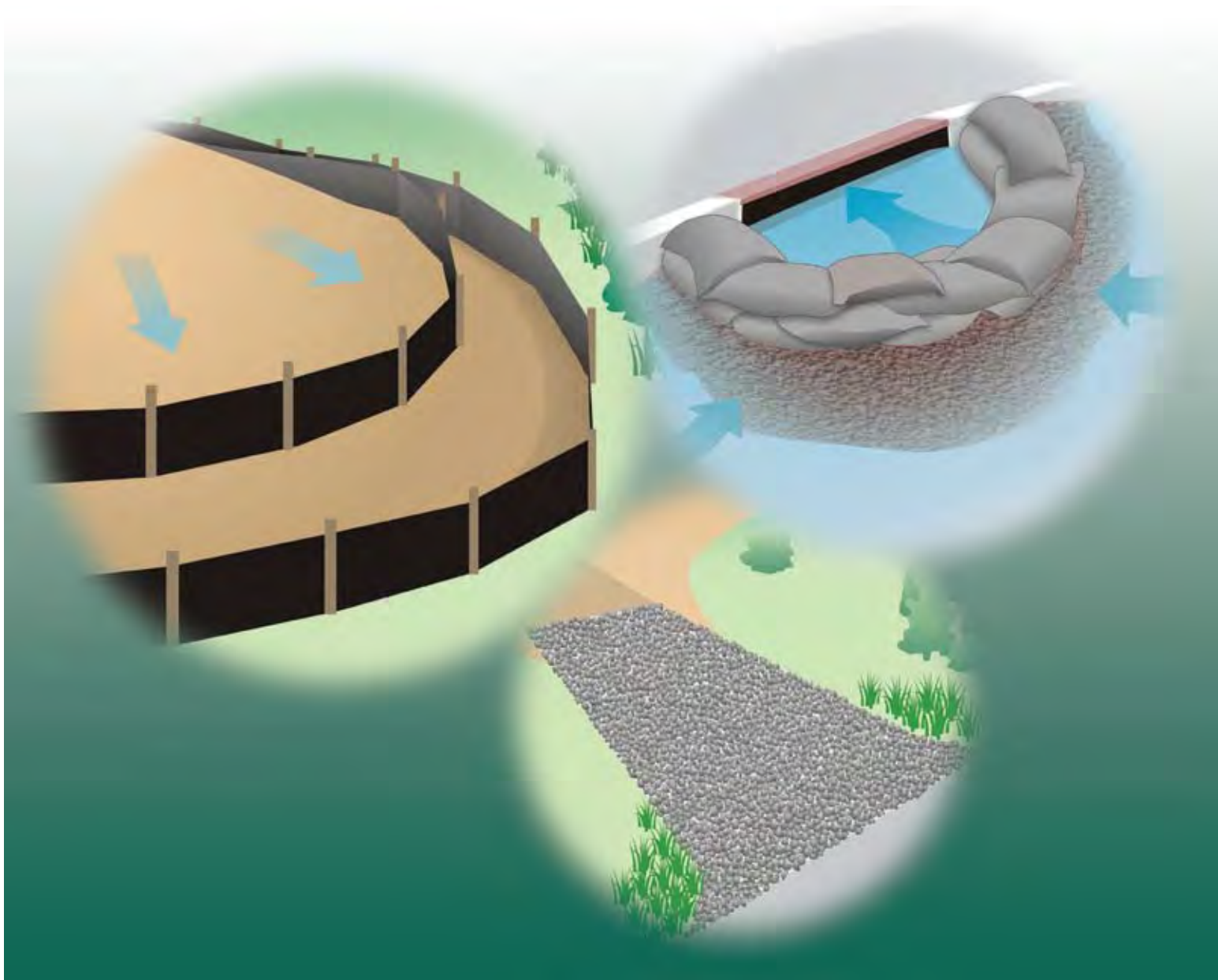

# Stormwater Compliance Assistance Toolkit for Small Construction Operators



Minnesota Pollution Control Agency

August 2008

wq-strm2-09

### ***Acknowledgments***

This guidance was developed under EPA Contract GS-10F-0268K, Task Order 1100 managed by Irvin J. Dzikowski, EPA Region V. The Minnesota Pollution Control Agency contract manager was Joyce Cieluch. The valuable assistance of Michael Findorff, Ken Moon, John Thomas, Reed Larson and others from the MPCA in developing this guidance is gratefully acknowledged.

Tetra Tech, Inc. drafted the guidance with John Kosco serving as project manager and primary author.

# Table of Contents

<b>Introduction</b> .....	<b>I</b>
<b>Chapter 1: MPCA’s construction stormwater permit</b> .....	<b>1</b>
Who is required to obtain the MPCA construction stormwater permit? .....	1
What type of projects do not require the construction stormwater permit? .....	2
What are some of the main permit requirements? .....	2
How do I apply for the construction stormwater permit? .....	3
Why Get a Permit? Addressing the problem of runoff .....	7
<b>Chapter 2: How do I develop a stormwater pollution prevention plan (SWPPP)?</b> .....	<b>8</b>
Steps to developing an effective SWPPP .....	8
Construction SWPPP Template .....	13
<b>Chapter 3: What kind of BMPs can I use in my SWPPP? .....</b>	<b>14</b>
Erosion Prevention and Sediment Control BMPs .....	14
Permanent Stormwater System BMPs .....	21
Pollution Prevention BMPs .....	23
<b>Chapter 4: Selected required activities during construction</b> .....	<b>26</b>
Inspections and Maintenance .....	26
Records .....	27
<b>Chapter 5: What do I have to do when the construction project is finishing? .....</b>	<b>28</b>
Final Stabilization .....	28
Notice of Termination .....	29
<b>Chapter 6: Resource listing</b> .....	<b>31</b>
<b>Chapter 7: Definitions</b> .....	<b>32</b>
<b>Attachment A: Construction SWPPP Template</b> .....	<b>35</b>
<b>Attachment B: Maintenance record example</b> .....	<b>45</b>

# Introduction

This guidance is intended as a resource to help small construction operators comply with the Minnesota Pollution Control Agency’s (MPCA) Construction Stormwater General Permit. The permit requires the development and implementation of a stormwater pollution prevention plan (SWPPP), which is your plan to decrease soil erosion and water pollution during construction. Small construction operators manage construction projects on sites less than 5 acres; however, large construction operators may also benefit from the information in this guidance.

This guidance explains who needs to apply for the permit, how to develop a stormwater pollution prevention plan (SWPPP), typical best management practices (BMPs) you may use during construction, and what you need to do during and after construction. In addition, a SWPPP template is included in Attachment A to help small construction operators develop a SWPPP that meets permit requirements.

This guidance does not replace the construction stormwater permit. All construction operators are strongly encouraged to read and understand the requirements described in the actual permit before applying for the permit and commencing construction.

It’s important to note that the BMPs described in this guide need to be executed in the proper manner or the expected benefits will not be realized and the site may be deemed in violation.

## Comments welcome

This is the second edition of the *Compliance Assistance Toolkit*. We welcome comments and suggestions on how it might be changed in future editions to better assist developers and construction firms in reducing stormwater runoff, both during construction and longterm. Send comments to:

Joyce Cieluch, MPCA Stormwater Compliance  
714 Lake Avenue, Suite 220, Detroit Lakes, MN 56501  
joyce.cieluch@pca.state.mn.us

# Chapter 1

## MPCA’s Construction Stormwater Permit

The MPCA issued the National Pollutant Discharge Elimination System/State Disposal System (NPDES/SDS) General Stormwater Permit for Construction Activity in August 2008. Owners and operators of construction activity disturbing **one acre or more** of land need to obtain the construction stormwater permit. Sites disturbing less than one acre within a larger common plan of development or sale that is more than one acre also need permit coverage.

### Who is required to obtain the MPCA construction stormwater permit?

The **owner** who signs the application is a permittee and is responsible for compliance with all terms and conditions of this permit. The **operator** (usually the general contractor) who signs the application is a permittee for Parts II.B., Part II.C. and Part IV. of the permit and is jointly responsible with the owner for compliance with those portions of the permit.

The owner can also be a lease, easement, or mineral rights license holder if the construction activity is for the leaseholder, or the owner can be the contracting government agency responsible for the construction activity. The owner and operator can be one and the same and must sign both sections in the application. However, if you are required to have permit coverage on a site that already has a NPDES permit, you may transfer the coverage to your name by using the Notice of Termination/Permit Modification form.

The operator is the person designated by the owner who has day-to-day operational control and/or the ability to modify project plans and specifications related to the stormwater pollution prevention plan (SWPPP). This person must be knowledgeable in those areas of the permit for which he is responsible (Part II.B and Part IV).

---

#### What is a “larger common plan of development or sale?”

A common plan of development or sale means a contiguous area where multiple separate and distinct construction activities are occurring under one overall plan (e.g., the operator is building on three half-acre lots in a 6-acre development). The “plan” in a common plan of development or sale is broadly defined as any announcement or documentation or physical demarcation indicating that construction activities may occur on a specific plot.

# What type of projects do not require this construction stormwater permit?

*Agricultural land disturbing activity* – if one or more acres of land will be disturbed for conversion of previously non-agricultural (crop) land to agricultural (crop) land, that activity is not required to have permit coverage.

*Silvicultural activity* – logging activity that is not associated with a construction project (not performed in order to clear land for anticipated construction activity) is not required to have permit coverage.

# What are some of the main permit requirements?

Permittees are required to develop a SWPPP and submit an application and \$400 application fee. Applications and other forms are available by calling the MPCA front desk at 800-657-3864 or 651-296-6300 and asking for Construction Stormwater Support Staff or visiting [www.pca.state.mn.us/water/stormwater/index.html](http://www.pca.state.mn.us/water/stormwater/index.html).

In addition to developing the SWPPP, permittees must implement the SWPPP, conduct regular inspections, and maintain BMPs. Inspections are required once every seven days during active construction and within 24 hours after a rainfall event greater than

0.5 inches in 24 hours. The next inspection must be conducted within seven days after that. At the end of the project, after all disturbed surfaces are stabilized, the permittee must submit a notice of termination (NOT) to let MPCA know that the construction activity is complete.

For most sites, construction may begin seven days after the application is postmarked. For sites that are more than 50 acres and that discharge to outstanding natural resource value waters (special waters) or impaired waters, the SWPPP and application materials must be submitted to the MPCA at least 30 days prior to commencing construction.

## What are “special waters?”

Additional requirements apply to construction sites that discharge within one mile of a special water. These waters can include:

- Wilderness areas (such as the Boundary Waters Canoe Area Wilderness, Voyageurs National Park, and parts of Kettle River and Rum River)
- Mississippi River (portions of)
- Scenic or recreational river segments (such as the Saint Croix River and Cannon River)
- Lake Superior
- Lake trout lakes
- Trout lakes
- Scientific and natural areas
- Trout streams

(See Appendix A, Part B of the construction stormwater permit for more information or use the Special Waters Search tool on the MPCA construction stormwater Web page.)

## How do I apply for the construction stormwater permit?

To help you comply with the requirements in the construction stormwater permit, the MPCA has developed the following “Steps to construction” to assist with the permit requirements. These steps are also available on the MPCA’s stormwater Web site. Remember that completing the application is one of the last things you do. Follow the steps below:

### ***Step 1. Identify the construction site boundaries, the latitude and longitude for the site, and the major phases of the project.***

The first thing you will need to do is identify the boundaries of your construction site. Identifying these construction site boundaries is important for determining which environmental resources may be at risk of being impacted by the project. This will also help you fill out the application, which requires you to fill out the total number of acres to be disturbed, the latitude and longitude of the center of the site, surface waters within one mile of the project that will receive stormwater from the site, and a copy of a USGS 7.5-minute quad or equivalent map with the site boundaries indicated. The latitude and longitude should correspond to a point “on site” which is closest to the approximate center of the construction site.

Identifying the major phases of a project will help you develop a plan to eliminate or minimize the potential environmental impacts.

### ***Step 2. Determine if additional permits are needed.***

It is your responsibility to contact other state and federal agencies and local governments to determine if additional permits are required in addition to the NPDES/SDS permit issued by MPCA. An example of an additional permit that could be required is a Section 404 permit from the Army Corps of Engineers if work will occur in a waterway or wetland. Local zoning offices are good places to check for required permits.

### ***Step 3. Determine if Environmental Review is needed.***

Contact the Minnesota Environmental Quality Board, the appropriate state agency, or local government agency to determine if your proposed project meets or exceeds the thresholds outlined in the state environmental review rules. For more information, see the two Web links below:

**Minnesota Environmental Quality Board: Environmental Review**

[www.eqb.state.mn.us/program.html?Id=18107](http://www.eqb.state.mn.us/program.html?Id=18107)

**MPCA: Environmental Review**

[www.pca.state.mn.us/programs/envr\\_p.html](http://www.pca.state.mn.us/programs/envr_p.html)

**Step 4. Understand the requirements of the NPDES/SDS Construction Stormwater General Permit.**

Read and understand the requirements in the NPDES/SDS Construction Stormwater Permit itself. MPCA has developed this guidance document and a summary of the permit (*Overview of Minnesota’s NPDES/SDS Construction Stormwater Permit, August 2008*) to help you understand the requirements. Copies of the permit and this summary are available at [www.pca.state.mn.us/water/stormwater/stormwater-c.html](http://www.pca.state.mn.us/water/stormwater/stormwater-c.html) or call the MPCA front desk at 651-296-6300 or 800-657-3864 and ask for Construction Stormwater Support Staff.

By signing and submitting the application described below, you are legally committing to follow the permit requirements. Make sure you know what these requirements are!

**Step 5. Identify waters that have the potential to receive a discharge of stormwater runoff from the project or discharge from a permanent stormwater management system.**

Page 2 generally describes “Special Waters.” Impaired waters are those identified by the State and EPA as waters not meeting their designated uses for specific pollutants. You will need to identify all waters, including special waters or impaired waters, that are within a mile of a discharge point from your project.

*Special Waters.* MPCA has developed an electronic map tool called Special Waters Search to help you identify these waters ([www.pca.state.mn.us/water/stormwater/stormwater-c.html](http://www.pca.state.mn.us/water/stormwater/stormwater-c.html)). You can also download the *Special Waters Document* from the MPCA’s stormwater Web site and use a quad map to identify your construction site and any special waters located within a mile of your site boundary.

*Impaired Waters.* Use the Special Waters Search or the *most recent TMDL List of Impaired Waters* ([www.pca.state.mn.us/water/tmdl/tmdl-303dlist.html](http://www.pca.state.mn.us/water/tmdl/tmdl-303dlist.html)) and a quad map to identify impaired waters within a mile of your site boundary. If you discharge to an impaired water, go to MPCA’s TMDL Web site to determine if that water has a TMDL that includes construction stormwater requirements.

Use a USGS 7.5-minute quad map to identify all waters (other than those identified above) that are within a mile of your construction site and have the potential of receiving a discharge from the site.

**Step 6. Determine if discharges from the construction site will impact endangered or threatened species, historic places, or calcareous fens.**

It is your responsibility to check if discharges from your site will impact endangered or threatened species, historic places, or calcareous fens. Information on calcareous fens is available using the *Special Waters Search* tool. Projects that discharge to a calcareous fen must get a letter of approval from the Minnesota Department of Natural Resources.





Information on endangered or threatened species and historic places is available from the contacts below:

**Minnesota Department of Natural Resources – Natural Heritage Program**

[www.dnr.state.mn.us/eco/nhnrp/nhis.html](http://www.dnr.state.mn.us/eco/nhnrp/nhis.html)

**Minnesota Historical Society – National Register Properties**

<http://nrhp.mnhs.org>

***Step 7. Prepare a stormwater pollution prevention plan (SWPPP).***

See Chapter 2 for more information on developing a SWPPP. You must have this SWPPP developed before you submit your application (step 10).

***Step 8. Re-check the receiving waters that the project discharges to.***

After developing your SWPPP, you may find that your project boundaries have moved or your discharge locations have changed. Double check the information you obtained in steps 5 and 6 to make sure it is still accurate. You will need to list the waters that receive a discharge from your construction site on the permit application form.

***Step 9. Complete the application form for an MPCA NPDES/SDS stormwater permit for construction activities.***

The application form includes permit application prerequisite questions, information about the construction activity, and information including signatures of the responsible parties (both the construction site owner and operator). A copy of the application form can be viewed and/or downloaded at [www.pca.state.mn.us/water/stormwater/stormwater-c.html](http://www.pca.state.mn.us/water/stormwater/stormwater-c.html) or by calling the MPCA front desk at 651-296-6300 or 800-657-3864 and asking for the Construction Stormwater Support Staff. The online file includes the application form/instructions and the entire permit.

***Step 10. Submit the application form and fee to the MPCA.***

Submit the signed application form, site map, and \$400 permit fee (do not include your SWPPP with the application but keep it on site) to the MPCA at:

MPCA  
Construction Stormwater Permit Program  
520 Lafayette Road North  
St. Paul, MN 55155-4194

You must submit the application at least 7 days before your construction start date, except for the following situations or alternatively you may submit your application on-line at least 48 hours before construction activity starts.

- Projects requiring an Individual Permit must submit applications at least 180 days before the construction start date.
- For projects with an alternative treatment technology (see Part III.C.5 of the permit), your application must be postmarked at least 90 days before the construction start date (include a copy of your SWPPP and alternative treatment method documentation with your application).
- For projects disturbing 50 acres or more and discharging within a mile of a special water or impaired water, you must submit (mail) the application fee and SWPPP for MPCA review at least 30 days before the construction start date.

Keep a copy of your completed application form.

***Step 11. Implement the SWPPP and begin construction.***

Unless notified to the contrary, you can begin construction after completing your SWPPP and after permit coverage is granted, which is 7, 30 or 90 days (depending on the applicable review period) after the postmark date of the completed application form, except for the following situations:

- For Individual NPDES/SDS Construction Stormwater Permit projects, permit coverage starts only after permit development, public input, and permit issuance.
- For projects with alternative technology, permit coverage starts after receiving an alternative treatment approval letter from the MPCA.
- For projects disturbing 50 acres or more and discharging within a mile of a special water or impaired water, permit coverage starts 30 days after the postmarked date of the completed application unless notified in writing that the SWPPP does not meet the general permit requirements.

If the application was submitted on-line, unless notified to the contrary, you can begin construction after completing your SWPPP and 48 hours after submitting your on-line application.



## Why get a permit? Addressing the problem of runoff

Construction activity can impact our water resources in two main ways: through water **quality** impacts from excessive erosion and discharge of other pollutants and through water **quantity** impacts caused by increases in impervious surfaces.

During a short period of time, construction activity can contribute more sediment to streams than would be deposited naturally over several decades, causing physical and biological harm to our waters. Uncontrolled construction site runoff can reduce clarity and lower dissolved oxygen in waterbodies; deposit excess sediments in waterways; and smother aquatic habitat including spawning sites. Runoff can also transport other pollutants attached to sediment particles such as pesticides and chemicals.

The addition of impervious surfaces increases the temperature, velocity and volume of discharges into wetlands, ponds and rivers. These factors reduce vegetative filtering and infiltration (less water soaks into the ground for recharge of the aquifer and base flow for streams). Impervious surfaces also increase flooding, which threatens human life and property, causes stream bank erosion, and damage to aquatic habitat and water quality.

There is a suite of enforcement options available to local government or state agencies to help achieve permit compliance, ranging from field requests and formal notices to local citations, administrative penalty orders, stipulation agreements, stop-work orders and permit revocations. Local governments may require developers to acquire a performance bond. State law provides for civil and criminal penalties for permit and water quality law violations of up to \$10,000 per violation per day.

An important element when assessing stormwater program violations is whether or not a permit has been applied for. The application process requires a site-specific Stormwater Pollution Prevention Plan (SWPPP), because experience has shown regulated parties are less likely to analyze site conditions relative to erosion and loss of sediment when a SWPPP is not developed. Lack of analysis becomes a key component of environmental harm considerations in the enforcement process.

While enforcement options are available, assisting contractors in achieving permit compliance and resource protection is our main focus and the goal of this publication.

# *How Do I Develop a Stormwater Pollution Prevention Plan (SWPPP)?*

## **Steps to developing an effective SWPPP**

The following steps will help you develop and implement an effective SWPPP:

- Step 1. Evaluate the site
- Step 2. Identify goals and objectives
- Step 3. Describe roles, the site and construction activity
- Step 4. Develop BMPs for construction activity
- Step 5. Develop BMPs for permanent stormwater management
- Step 6. Implement the SWPPP
- Step 7. Inspect, maintain and evaluate BMPs
- Step 8. Update the SWPPP

The person preparing the SWPPP must have received appropriate training. (Part III.A.2.)

### ***Step 1: Evaluate the site***

Begin by evaluating the site to determine the critical issues that will need to be addressed in the SWPPP. Determine how stormwater will drain from the site, including the number and location of discharge points. Identify any surface waters within a mile that will receive runoff from your site. Note whether any are special or impaired waters. Identify any storm drain inlets that may receive a discharge from your project.

Identify potential sources of pollution that may reasonably be expected to affect the quality of stormwater discharges from your construction site. These could be fueling areas, concrete washouts, material storage areas, trash containers, and other materials that can be mobilized by stormwater runoff. You must also identify potential construction exits from the site, and determine if there are steep slopes on the project that will require extra protection.

**Step 2: Identify project goals and objectives**

Your overall goals during construction are to prevent erosion and minimize any sediment transport from your site. Post-construction goals are to reduce or minimize the impact on receiving waters from stormwater discharges from the site. You will do this primarily through developing and implementing your SWPPP.

Every project must also try to meet the following objectives:

- *Minimize disturbed areas and protect vegetation.* If practical for your site, consider phasing construction activities so that you only clear the portion of the site that you will be working on in the near future. Identify areas of vegetation, trees, and sensitive areas that must be protected by placing a physical barrier around these areas.
- *Protect slopes and channels.* Convey stormwater runoff around the top of slopes and stabilize slopes as soon as possible. Where a large amount of runoff must flow over a disturbed slope, use a slope drain to convey the water to the bottom of the slope for minimum erosion. Avoid disturbing natural channels.
- *Reduce impervious surfaces and promote infiltration.* Reducing impervious surfaces will ultimately reduce the amount of runoff leaving your site. Also, divert rooftops and other impervious surfaces to grassy areas when possible to promote infiltration.
- *Control the perimeter of your site.* Divert runoff coming on to your site. Install BMPs such as silt fences to capture sediment before it leaves your site.
- *Follow pollution prevention measures.* Provide proper containers for waste and garbage from your site. Store hazardous materials and chemicals so that they are not exposed to stormwater runoff. Define and place signs for concrete washout. Do not degrease machinery on-site.

**Step 3: Describe roles, the site and construction activity**

The construction *owner* is the person possessing the title of the land on which the construction activities will occur. The construction *operator* has operational control over construction plans and specifications and can commit resources to implementing the BMPs described in the SWPPP. However, stormwater pollution control is typically not the job of a single person; therefore, you must describe in the SWPPP the roles and responsibilities of everyone involved in implementing the SWPPP.

The owner is responsible for identifying a person (or job title such as foreman) who is knowledgeable, experienced and trained in the application of erosion and sediment control BMPs before and during construction. The owner must also identify the person (or entity) who will have the responsibility for long-term operation and maintenance of the permanent stormwater management system. The owner must also develop a chain of responsibility with all operators on the site to ensure that the SWPPP will be implemented and stay in effect until the construction project is complete; the entire site has undergone final stabilization; and a Notice of Termination (NOT) has been submitted to the MPCA.



Provide a brief description of the nature of the construction activity. This must include:

- The function of the project (e.g., low density residential, shopping mall, highway, etc.);
- The intended sequence and timing of activities that disturb soils at the site; and
- Estimates of the total area expected to be disturbed by excavation, grading, or other construction activities, including dedicated off-site borrow and fill areas.

### **Site Map**

Include in your SWPPP a legible site map, showing the entire site, and identifying:

1. Existing and final grades, including dividing lines and direction of flow for all pre and post-construction stormwater runoff drainage areas located within the project limits;
2. Impervious surfaces and soil types;
3. Locations of areas that will not be disturbed;
4. Location of areas where construction will be phased in to minimize duration of exposed soil areas;
5. All surface waters and existing wetlands, which can be identified on maps such as USGS 7.5-minute quad maps within one mile from the project boundaries, which will receive stormwater runoff from the construction site, during or after construction. If these waters do not fit onto the site map, identify them with an arrow indicating the direction and distance to the surface water; and
6. Methods to be used for final stabilization of all exposed soil areas.

Your site plan is a dynamic document. As conditions change at the construction site, such as the locations of BMPs, you must update your site plan to reflect those changes. The person overseeing the implementation of the SWPPP has to have the appropriate training (Part III A.2.).

### ***Step 4: Develop BMPs for construction activity***

Select appropriate BMPs to control stormwater runoff during construction. The following BMPs are commonly used on small sites disturbing less than five acres:

- *Protect storm drain inlets.* All inlets receiving stormwater from the project must be protected until all disturbed areas with a potential for discharging to the inlet have been stabilized. Inlet protection may be removed for a particular inlet if a specific safety concern has been identified and you have received written correspondence from the jurisdictional authority.
- *Establish stabilized construction exits.* Use stone pads, concrete or steel wash racks, or equivalent practices to contain vehicle tracking of sediment. Sweep the street if necessary.

- *Protect slopes.* Slopes longer than 75 feet on a 3:1 grade must be broken up using sediment control practices (e.g., sediment barrier). All exposed soil areas must be stabilized as soon as possible to limit soil erosion, but in no case later than 14 days after the construction activity in that portion of the site has temporarily or permanently ceased. If you are within one mile of impaired or special waters, all exposed soil must be stabilized as soon as possible but in no case later than seven days after the construction activity in that portion of the site has temporarily or permanently ceased.
- *Protect ditch bottoms (normal wetted perimeter).* Any temporary or permanent ditch that drains water from a construction site or diverts water around a site, must be stabilized within 200 lineal feet from the property line **or** from the point of discharge to any surface water. Stabilization must take place within 24 hours of connecting to a surface water.
- *Install silt fence (or equivalent sediment control) along the down slope perimeter.* Use practices such as silt fence, sediment traps, or other practices to capture runoff leaving the site.
- *Control any dewatering practices.* Discharge dewatering or basin draining water to a temporary or permanent sedimentation basin on the project.
- *Control the location of and runoff from temporary stockpiles.* Place temporary stockpiles away from surface waters including stormwater conveyances such as curb and gutter systems, or conduits and ditches. Control runoff from stockpiles by tarping, using silt fences or other effective sediment controls.
- *Implement pollution prevention measures.* Control solid waste using proper trash management practices. Properly store oil, gasoline, paint and other hazardous substances. External washing of vehicles must be limited to a defined area on the site. No engine degreasing allowed on site. Runoff must be contained. Concrete washout must be limited to defined sites. These sites have to have a sign. Be aware that if your site has a point that is within one mile and discharges to special waters or impaired waters (impaired because of phosphorous, turbidity dissolved oxygen, or biotic impairment) additional BMPs are needed. These additional BMPs can be found in Appendix A of the permit. (Part I.A.7, Part III.A.9, Appendix A .B.9)

***Step 5: Develop BMPs for permanent stormwater management***

If your project replaces vegetation and/or other pervious surfaces with one or more acres of cumulative impervious surface, then you will need to design practices to treat the runoff from these impervious surfaces. At least ½ inch of runoff (called the water quality volume or live storage) from the new impervious surfaces must be treated.

Calculations for determining the size of your stormwater management system should be kept with the SWPPP.

The methods available for treating the water quality volume include (see the permit for all of the design requirements):

- *Wet sedimentation basins.* A permanent storage volume (dead storage) of 1800 cubic feet/acre that drains to the basin must be provided. The water quality volume (live storage) must be discharged at no more than 5.66 cubic feet per second (cfs) per acre of surface area of the pond.
- *Infiltration/filtration.* Options include infiltration basins, infiltration trenches, rainwater gardens, sand filters, organic filters, bioretention areas, enhanced swales, dry storage ponds with underdrain discharge, off-line retention areas, and natural depressions.
- *Regional ponds.* You must obtain written authorization from the pond owner before discharging to a regional pond and the pond must meet the permit's design requirements.
- *Combination of practices.* You can use a combination of the above practices.
- *Alternative method.* You can propose an alternative method, but it must achieve 80% removal of total suspended solids on an annual average basis and MPCA must approve your plan before construction.

For those areas of your project where there is no feasible way to meet the requirements for the water quality volume, you may use other treatment such as grassed swales, smaller ponds, or grit chambers prior to discharging to surface waters. You can treat a cumulative maximum of three acres or 1% of project size (whichever is larger) in this manner.

See part III.C of the general permit for more information and minimum design requirements of the permanent stormwater management system. Additional information on permanent stormwater management practices is available in MPCA's guidance document called *Protecting Water Quality in Urban Areas*. This document is available for ordering or downloading on the MPCA's Web site: [www.pca.state.mn.us/water/pubs/sw-bmpmanual.html](http://www.pca.state.mn.us/water/pubs/sw-bmpmanual.html).

### ***Step 6: Implement the SWPPP***

You must implement your SWPPP *before* construction activity begins. This typically means installing storm drain inlet protection, stabilizing construction exits, and installing perimeter sediment controls before clearing and grading activities begin. The person who implements the SWPPP has to have appropriate training. (Part III.A.2)

Additional BMPs must be installed as soon as possible during construction.

### ***Step 7: Inspect, maintain and evaluate BMPs***

Your responsibility doesn't stop after your BMPs are implemented. You are required to periodically inspect and maintain the BMPs on your site and you need to have received



the appropriate training (Part III A.2). See Chapter 4 for more information on the inspection and maintenance requirements.

You must also evaluate whether the BMPs you have selected are working. If they are not, modify your practices. For example, if your perimeter silt fence is frequently failing, you may need additional erosion controls upslope of the silt fence. You must continuously evaluate the practices you've implemented to determine if something better would work.

### **Records**

You must keep the SWPPP, all changes to it, and inspection and maintenance records at the construction site. The SWPPP can be kept in either the field office or in an on-site vehicle. After the construction project is complete, keep the SWPPP on file for at least three years after submittal of your NOT.

### ***Step 8: Update the SWPPP***

Finally, update your on-site SWPPP as necessary during construction to reflect any changes made. The MPCA requires you to update your SWPPP whenever:

- There is a change in design, construction, operation, maintenance, weather or seasonal conditions that has significant effect on the discharge of stormwater from your site;
- Inspections indicate the SWPPP is not effective in minimizing the discharge of pollutants to surface waters;
- The SWPPP is not consistent with the requirements in the permit; or
- The MPCA notifies you in writing that changes are needed.

Updates to your SWPPP must also include updates to your site plan as necessary to reflect changes in where BMPs are being implemented on-site.

## **Construction SWPPP Template**

To help you develop a construction SWPPP, the MPCA has developed a template which is provided as Attachment A in this guide. This template is also available as a Microsoft Word document on the MPCA stormwater construction Web site.

The Word document allows you to “fill in the blanks” when developing your SWPPP. This is only a template, you may need to include additional information based on the conditions at your site, or based on requirements from local agencies.

## *What kind of BMPs can I use in my SWPPP?*

### **Erosion Prevention and Sediment Control BMPs**

You can avoid many problems at your construction site by following the advice “divert the clean water, trap the dirty water.” Limit the amount of ground you disturb and re-vegetate as soon as possible to prevent runoff from getting dirty in the first place. Divert clean water coming on to your site so you don’t have to spend extra money treating it. Finally, for the areas of the construction site you do have to disturb, design practices to minimize erosion and then select practices to control sediment once erosion occurs. Note that you must include in the SWPPP the estimated preliminary quantities anticipated at the start of the project for the site of the project for all erosion prevention and sediment control BMPs (Part III A.4.b). Below are some common BMPs to help you achieve these goals. Note that it is important to construct BMPs properly in order to achieve the desired benefits.

The BMPs below are intended to provide information on selecting appropriate BMPs for your SWPPP. For detailed design guidance, refer to one of the guidance documents below or contact a stormwater design engineer.

- MPCA’s *Protecting Water Quality in Urban Areas: Best Management Practices for Dealing with Stormwater Runoff from Urban, Suburban and Developing Areas of Minnesota* (2000).  
[www.pca.state.mn.us/water/pubs/sw-bmpmanual.html](http://www.pca.state.mn.us/water/pubs/sw-bmpmanual.html)
- Metropolitan Council’s *Minnesota Urban Small Sites BMP Manual: Stormwater Best Management Practices for Cold Climates* (2001).  
[www.metrocouncil.org/environment/Watershed/bmp/manual.htm](http://www.metrocouncil.org/environment/Watershed/bmp/manual.htm)

You should know that if you are going to prepare the SWPPP, you should have received appropriate training (Part III.A.2.).

## ***Minimize disturbance***

You must plan for and implement appropriate construction phasing to minimize exposed soil at any one time. Schedule clearing, grading, excavating and other land disturbing activities only when you will be actively working on that portion of the project.

Preserve existing vegetation at the site where possible. This includes areas next to streambanks, steep slopes, floodplains, and other sensitive areas. The location of areas not to be disturbed must be delineated (e.g., with flags, stakes, signs, silt fence, etc.) on the development site before work begins.

### **Permit requirement (Part IV.B.1):**

- The Permittee must plan for and implement appropriate construction phasing, vegetative buffer strips, horizontal slope grading, and other construction practices that minimize erosion...

## ***Protect slopes and ditch bottoms (normal wetted perimeters)***

Use terracing or soil roughening practices to decrease runoff velocities, trap sediment, and increase infiltration on slopes. Tracking with machinery up and down (perpendicular to the slope) will provide grooves that catch seed and rainfall, reducing runoff and making it more difficult for rills and gullies to form on the slope.

For steep slopes, consider blankets, seeding or hydromulch to stabilize the slope.

Slopes with a grade of 3:1 or more must not have an unbroken slope length greater than 75 feet. Consider benching, staked fiber rolls, or other practices to break up the slope.

### **Permit requirement (Part IV.B.2-3):**

- All exposed areas must have temporary erosion protection or permanent cover for the exposed soil areas as soon as possible but in not case later than 14 days after the construction activity in that portion of the site has temporarily or permanently ceased.
- Any temporary or permanent ditch that drains water from a construction site or diverts water around a site, must be stabilized within 200 lineal feet from the property line **or** from the point of discharge to any surface water. Stabilization must take place within 24 hours of connecting to a surface water.

## ***Storm drain inlet protection***

Storm drain inlet protection prevents sediment from entering a storm drain by surrounding or covering the inlet with a filtering material. This allows sediment-laden runoff to pond and settle before entering the storm drain.

Several types of filters are commonly used for inlet protection: silt fence, sand bags or block and gravel. The type of filter will depend on inlet type (curb inlet, drop inlet), slope, and amount of flow. Many commercial inlet filters are also available. Some commercial inlet filters are placed in front or on top of an inlet, others are placed inside the inlet and under the grate.

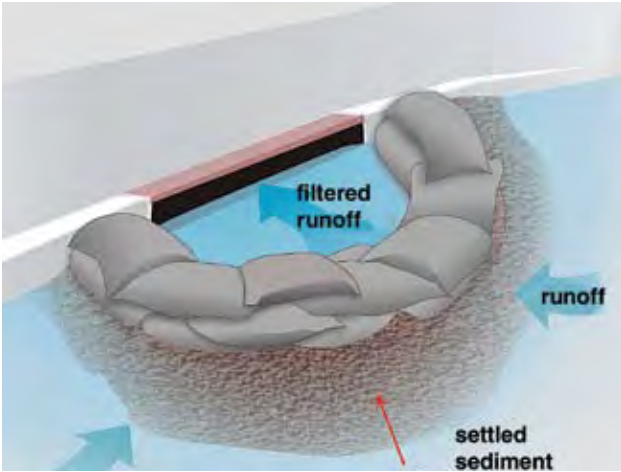

**Figure 1.** Sand or gravel bags can be used to filter stormwater runoff before entering a catch basin. Commercial products are also available that fit in front of or inside the catch basin.

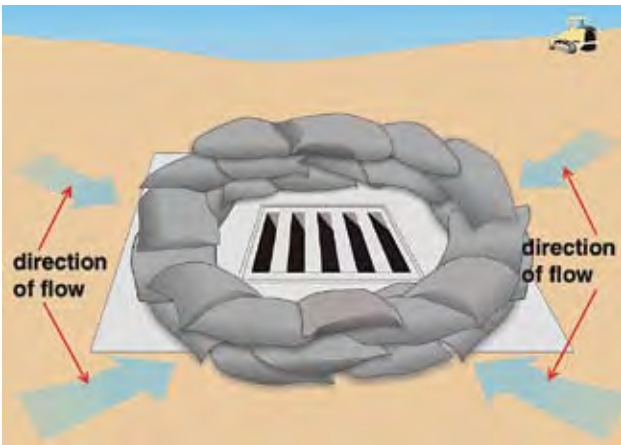

**Figure 2.** Sand or gravel bags used to protect a drop inlet.

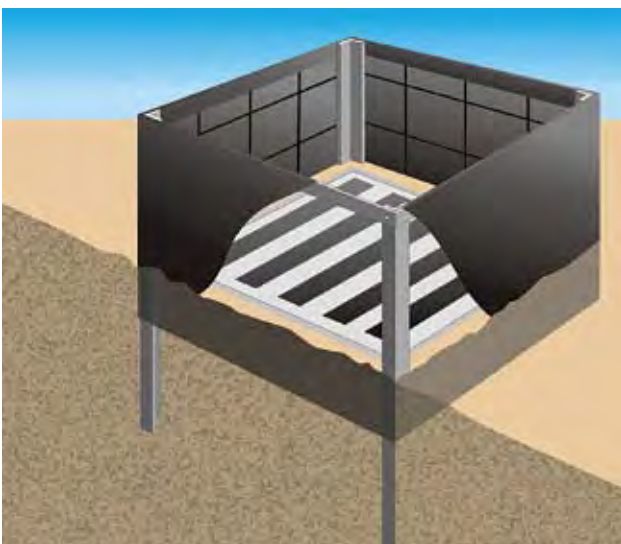

**Figure 3.** Silt fence can also be used to protect a drop inlet.

**Permit requirements:**

- All storm drain inlets must be protected by appropriate BMPs during construction until all sources with potential for discharging to the inlet have been stabilized. Inlet protection may be removed for a particular inlet if a specific safety concern has been identified and you have received written correspondence from the jurisdictional authority. (Part IV.C.4)
- All sediment control BMPs must be inspected to ensure integrity and effectiveness. All nonfunctional BMPs must be repaired, replaced, or supplemented with functional BMPs (Part IV.E.4)

**Installation tips:**

- Install inlet protection as soon as storm drain inlets are installed (or before land disturbance activities begin in areas with existing storm drain systems)
- Protect all inlets that will receive stormwater from your construction project.
- Inlet protection is a secondary BMP. Make sure you have other erosion prevention and sediment control BMPs in place.
- Safety is a consideration when determining the best method to protect an inlet. For example, if two feet of ponded water around an inlet will cause flooding of a nearby roadway, have an overflow at one foot of depth and additional controls at the outlet.

**Maintenance:**

- Inspect inlets at least weekly and within 24 hours after each rain event of at least .5 inches within a 24-hour period. The next inspection must be conducted within seven days after that.
- Remove accumulated sediment behind the inlet protection and any sediment that enters a storm drain.
- Replace the inlet protection when it becomes damaged.

## ***Stabilized Construction Exit***

A rock construction exit can reduce the amount of mud transported onto paved roads by vehicles. The construction exit does this by removing mud from the vehicle tires before the vehicle enters a public road.

In some cases, a wash rack may be used to wash tires and keep driving surfaces mud-free. Wash water must be directed to a suitable settling area and must not be discharged to a stream or storm drain.

### **Permit requirements:**

- Vehicle tracking of sediment from the construction site must be minimized by BMPs such as stone pads, concrete or steel wash racks, or equivalent systems. Street sweeping must be used if such BMPs are not adequate to prevent sediment from being tracked onto the street. (Part IV.C.6)
- Construction site vehicle exit locations must be inspected for evidence of off-site sediment tracking onto paved surfaces. Tracked sediment must be removed from all off-site paved surfaces within 24 hours of discovery, or if applicable, within a shorter time. (Part IV.E.4.d)

### **Installation tips:**

- The exit must be at least 50 feet long (generally the length of two dump trucks), and the exit must be graded so runoff does not enter the adjacent street.
- Place a geotextile fabric under a layer of aggregate at least 6 inches thick. The aggregate must be a minimum of 1 to 3 inches (larger aggregate is better).
- Direct employees to use the designated construction exits.

### **Maintenance:**

- Replenish or replace aggregate if it becomes clogged with sediment.
- Sweep the street regularly.



**Figure 4.** Stabilized construction exit.

## ***Silt fence and sediment barriers***

Silt fence is a temporary sediment barrier consisting of a geotextile, which is attached to supporting posts trenched into the ground. The purpose of a silt fence is to filter out sediment-laden runoff as it ponds on the uphill side. However, a silt fence is only designed for runoff from small areas, and is not intended to handle flows from large slopes or in areas of concentrated flow.

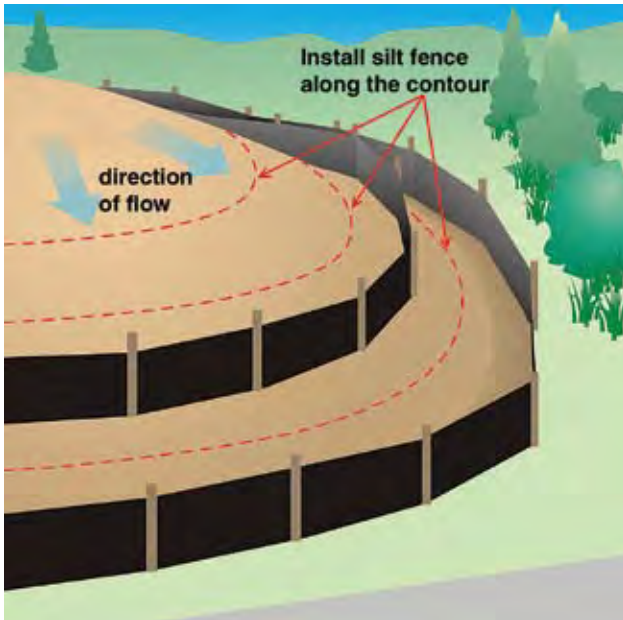

**Figure 5.** Illustration of silt fences installed along the contour.

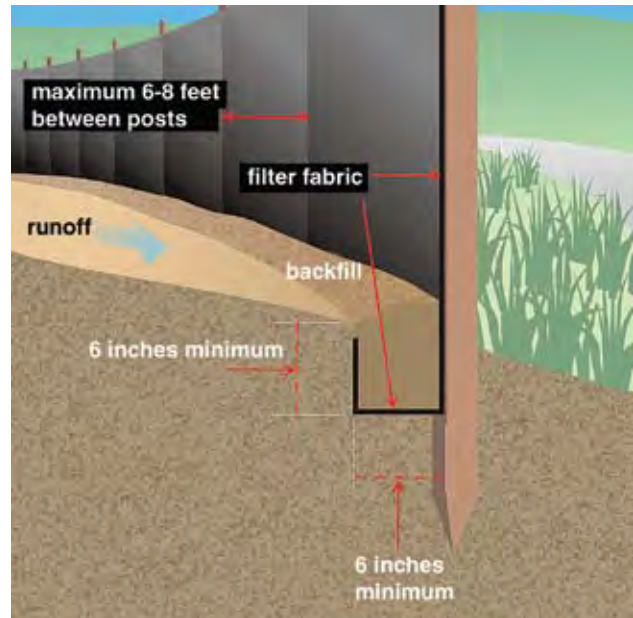

**Figure 6.** Detail of silt fence installation.



**Figure 7.** Illustration of "J-hooks" used during silt fence installation.

### **Permit requirements:**

- Sediment control practices must be established on all down-gradient perimeters before any up-gradient land disturbing activities begin. These practices must remain in place until final stabilization has been established (Part IV.C.2).
- All silt fences must be repaired, replaced, or supplemented when they become nonfunctional or the sediment reaches 1/3 of the height of the fence. These repairs must be made within 24 hours of discovery, or as soon as field conditions allow access (Part IV.E.4.a).

### Installation tips

#### DO:

- Install silt fence along the contour of a slope
- Trench in the silt fence on the uphill side (trench should be 6 inches deep by 6 inches wide)
- Install stakes on the downhill side of the fence
- Curve the end of silt fences up-gradient so that it contains the muddy runoff

#### DON'T:

- Install silt fence at the top of hills, or up and down hills
- Install silt fence in ditches, channels or areas of concentrated flow
- Use silt fence for areas that drain more than ¼ acre per 100 ft. of fence.
- Rely on silt fence as your only BMP; use it in combination with other practices.

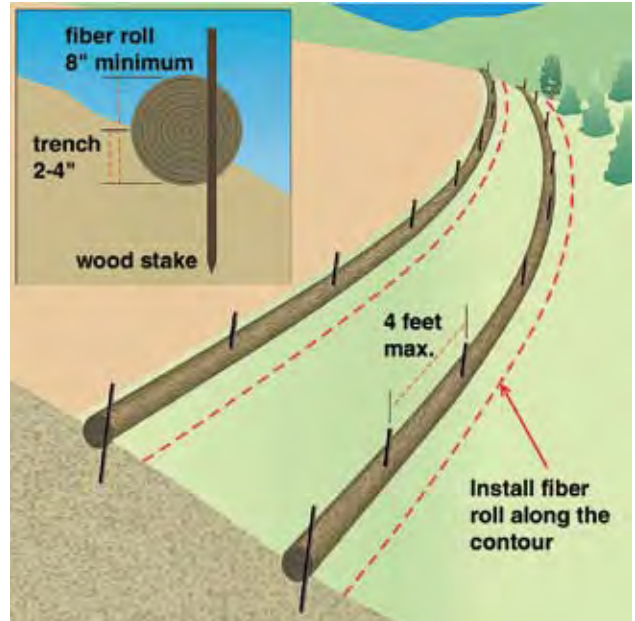

Figure 8. Fiber roll installation and detail.

Sediment barriers such as fiber rolls or wattles function similar to silt fence, and many of the same installation tips apply.

#### Maintenance:

- Remove sediment when it reaches 1/3 of the height of the fence
- Replace the silt fence where it is worn, torn, or otherwise damaged.

### ***Diversion ditches/berms***

Diversion ditches or berms direct off-site runoff away from unprotected slopes or direct sediment-laden runoff to a sediment trapping structure. A diversion ditch can be located at the upslope side of a construction site to prevent surface runoff from entering the disturbed area. Ditches or berms on steeper slopes may need to consider erosive velocities. Also, ensure diverted water is released through a stable outlet and does not cause downstream flooding.

#### Installation tips:

- Divert runoff coming on to your construction site (generally used to protect areas of five acres or less).



Figure 9. Diversions must be used to divert stormwater away from disturbed areas.

- Clean runoff must be discharged to a stable outlet or channel, sediment-laden water must be diverted to a sediment-trapping structure.

The ditches or swales must be stabilized within 200 lineal feet from the property edge, or from the point of discharge into any surface water. Stabilization of the last 200 lineal feet must be completed within 24 hours after connecting to a surface water.

Stabilization of the remaining portions of any temporary or permanent ditches or swales must be complete within 14 days after connecting to a surface water and construction in that portion of the ditch has temporarily or permanently ceased.

**Maintenance:**

- Inspect diversions and berms after each rain event (within 24 hours of a .5 inch rain in a 24-hour period), including outlets.
- Remove any accumulated sediment.

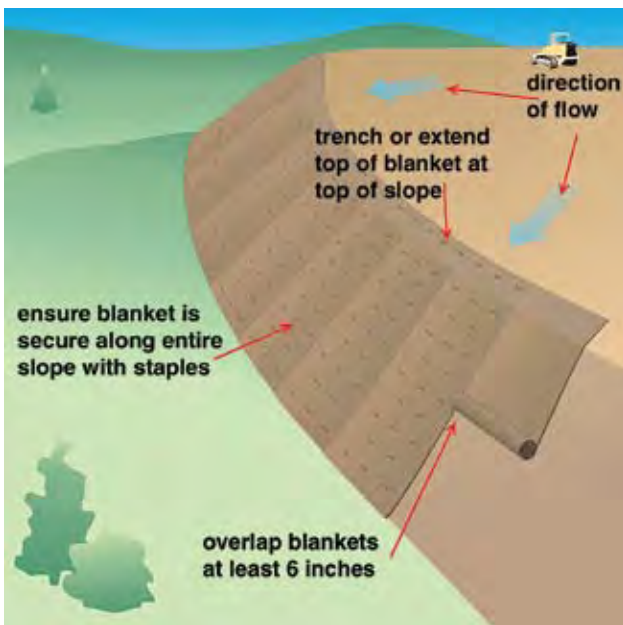

Figure 10. Erosion control blanket.

**Mats, mulches, and blankets**

Mats, mulches, and blankets are used for temporary stabilization and establishing vegetation of disturbed soils. Mats and blankets are typically used on slopes or channels while mulches are effective in helping to protect the soil surface and foster vegetation.

**Installation tips:**

- Mats and blankets must be used on slopes steeper than 3:1 and in swales or long channels (mulches are generally not recommended on slopes greater than 3:1).
- Trench the top of the blanket in to prevent runoff from flowing under the blanket.
- Overlap the end of each blanket and mat.
- Staple blankets and mats according to specifications.
- Do not place mulch in areas of concentrated flow.

**Maintenance:**

- Periodically check for signs of erosion or failure.
- Apply additional mulch or repair blanket/mat if necessary.
- Continue inspections until vegetation is established.



**Temporary sediment trap or pond**

A temporary sediment trap, pond or basin is a temporary ponding area formed by constructing an earthen embankment with an outlet across a swale. Temporary sediment traps are intended to detain sediment-laden runoff from small, disturbed areas long enough to allow the majority (at least 75%) of the sediment to settle out.

Sediment traps are designed for small areas. The volume of the trap must be at least 1,800 cubic feet per acre of contributing drainage.

**Permit requirements:**

- See Part III.B of the permit for temporary sediment basin design details.

**Installation tips:**

- Install the basin in the low point of your construction site.
- Install the basin before land disturbing activities begin.
- Install a gravel outlet following BMP design
- The basin must not be installed in a main stream.

**Maintenance:**

- Remove the sediment in the basin when it reaches about 1/2 the design volume.
- Check the outlet for needed maintenance.

**Permanent Stormwater System BMPs**

Permanent stormwater management BMPs are required when a project will replace vegetation and/or other pervious surfaces with one or more acres of cumulative impervious surface. A water quality volume of 1/2 inch of runoff from the new impervious surface (1 inch when discharging to special or impaired waters) must be treated by one of the methods below.

If you are creating one acre or more of new imperious surface, then your SWPPP must describe how you will treat the water quality volume from this area, including design calculations. See Part III.C of the permit for all design requirements.

**Wet Sedimentation Basin**

A wet sedimentation basin is a controlled stormwater release structure that is designed to provide settling time for sediment and other particulates before runoff is discharged. A permanent volume of 1800 cubic feet of storage below the outlet pipe for each acre that drains to the basin is required. The depth of the permanent volume must be at least 3 feet but less than 10 feet.

The basin outlet must be designed so that the water quality volume is discharged at no more than 5.66 cubic feet per second per acre of surface area of the pond, and a stabilized emergency overflow must be designed.

Adequate maintenance access must also be provided to the pond.

## ***Infiltration/Filtration***

Infiltration/Filtration options include but are not limited to: infiltration basins, infiltration trenches, rainwater gardens, sand filters, organic filters, bioretention areas, enhanced swales, dry storage ponds with underdrain discharge, off-line retention areas and natural depressions.

Vehicles must be kept away from all infiltration areas to avoid compacting the soil.

Infiltration must be used only as appropriate to the site and land uses. Settleable solids, floating materials, oils and grease must be removed from the runoff to the maximum extent practicable before runoff enters the infiltration/filtration system. Filtration systems must have a reasonable chance of achieving approximately 80% removal of total suspended solids. Use a pretreatment system such as a vegetated filter strip, small sedimentation basin, or water quality inlet before the stormwater discharges to the infiltration or filtration system. Design systems to treat a water quality volume of ½ inch, and discharge through the soil or filter media in 48 hours or less.

You must evaluate the impact of constructing an infiltration practice on existing hydrologic features (e.g., existing wetlands) and try to maintain pre-existing conditions (e.g., do not breach a perched water table which is supporting a wetland). You must provide a way to visually verify that the system is operating as designed.

Do not use infiltration systems when receiving runoff from industrial areas with exposed significant materials or from vehicle fueling and maintenance areas. Refer to the Minnesota Stormwater Manual for discussions on infiltration ([www.pca.state.mn.us/water/stormwater/stormwater-manual.html](http://www.pca.state.mn.us/water/stormwater/stormwater-manual.html))

### **Installation tips:**

- Do not install infiltration systems until the contributing drainage area has been fully stabilized.
- Keep sediment and runoff away from the infiltration system during construction by using diversion berms.
- Provide maintenance access along with a maintenance plan.
- Must have 3 feet of separation from the seasonally saturated soils (or from bedrock) and the bottom of the proposed infiltration system.
- Keep vehicles away from all infiltration areas to avoid compacting the soil.

## ***Regional Ponds***

You may discharge to a regional pond under the following circumstances:

- Discharge is to a constructed pond, and not a natural wetland or waterbody,
- The pond is designed in accordance with the general permit's design requirements for a wet sedimentation basin,

- You must obtain written authorization from the applicable local governmental unit or private entity that owns and maintains the regional pond before applying for the permit (include this in your SWPPP), and
- The written authorization must show that the regional pond will discharge the water quality volume at no more than 5.66 cfs per acre of pond surface area.

### ***Combination of Practices***

A combination of the above practices may be used to meet the water quality volume treatment requirement. For example, ¼ inch may be infiltrated and ¼ inch may be treated through a wet sedimentation basin. The SWPPP must contain documentation (infiltration computer model results or calculations, etc.) identifying the volume that each practice addresses.

### ***Alternative Method***

An alternative, innovative treatment system may be proposed to achieve 80% removal of total suspended solids on an annual average basis. If you choose this method, you must submit all calculations, drainage areas, plans and specifications to the MPCA at least 90 days prior to the scheduled start of your construction activity for review. You cannot start construction until you have received an approval letter from the MPCA.

You must also develop a 2-year monitoring plan to sample runoff from the proposed alternative treatment method. The plan must include a discussion of the methods that will be used to collect samples, location where samples will be taken (upstream and downstream of the proposed method), frequency of samples (minimum of six events sampled), the lab that will be used to analyze the samples, and quality assurance and quality control methods to be used. The plan must also include a schedule for submitting the monitoring data annually.

## **Pollution Prevention BMPs**

### ***Solid Waste***

Provide appropriate containers for solid waste and empty them frequently. If necessary, containers must be covered to prevent wind from blowing the waste around the construction site. Solid waste includes collected sediment, asphalt and concrete millings, floating debris, paper, plastic, fabric, construction and demolition debris and other wastes.

Follow MPCA disposal requirements for all solid waste.

#### **Permit requirement:**

- *Solid Waste:* Collected sediment, asphalt and concrete millings, floating debris, paper, plastic, fabric, construction and demolition debris and other wastes must be disposed of properly and must comply with the MPCA disposal requirements (Part IV.F.1).

## **Hazardous Materials**

Hazardous materials must be properly stored, and must have secondary containment to prevent spills, leaks or other discharges. These materials must be stored in a shed or building that can be locked to prevent vandalism or unauthorized access. Hazardous materials include oil, gasoline and paint, so ensure that these materials are also properly stored.

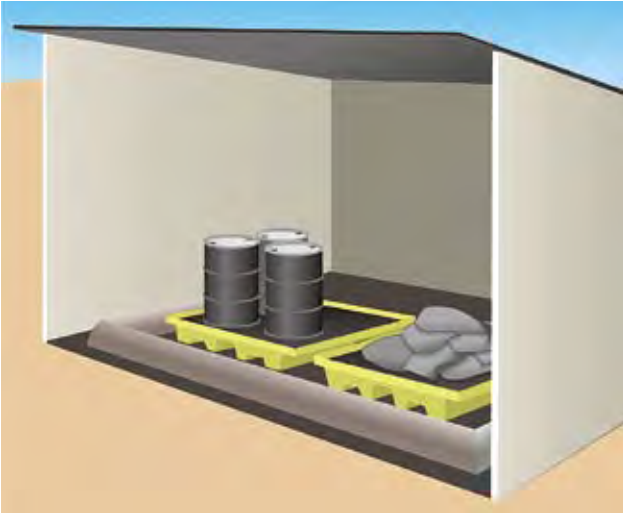

**Figure 11.** Example of hazardous materials storage (doors removed for illustrative purposes only). Access to hazardous materials must be restricted.

Follow MPCA regulations when storing and disposing of hazardous waste. This must include proper labeling of hazardous wastes. Additional information can be found at [www.pca.state.mn.us/waste/index.html](http://www.pca.state.mn.us/waste/index.html)

### **Permit requirement:**

- *Hazardous Materials:* Oil, gasoline, paint and any hazardous substances must be properly stored, including secondary containment, to prevent spills, leaks or other discharge. Restrict access to storage areas to prevent vandalism. Storage and disposal of hazardous waste must comply with MPCA regulations. (Part IV.F.2)

## **Vehicle washing**

Avoid washing vehicles on the construction site. If washing is necessary, designate a site where the runoff can be contained and properly disposed of, such as an adequately sized sedimentation basin.

Engine degreasing is not permitted on the construction site. Maintenance of vehicles must occur in a properly equipped shop, and not on the construction site.

### **Permit requirement:**

- External washing of trucks and other construction vehicles must be limited to a defined area of the site. Runoff must be contained and waste properly disposed of. No engine degreasing is allowed on site. (Part IV.F.3)

## ***Concrete Washout***

The liquid and solid wastes generated by concrete washout operations have to be deposited in leak-proof containers and afterwards, the wastes must be disposed of properly and in compliance with MPCA regulations. The concrete washout needs to be dewatered and then it can be ground and recycled or taken to a demolition landfill. Signs need to be posted of the site(s) where concrete washout operations take place.

For additional information, please check the construction stormwater concrete washout fact sheet at [www.pca.state.mn.us/water/stormwater/stormwater-c.html](http://www.pca.state.mn.us/water/stormwater/stormwater-c.html).

### **Permit requirement:**

- *Concrete washout onsite:* All liquid and solid wastes generated by concrete washout operations must be contained in a leak-proof containment facility or impermeable liner. A compacted clay liner that does not allow washout liquids to enter ground water is considered an impermeable liner. The liquid and solid wastes must not contact the ground, and therefore must not be runoff from the concrete washout operations or areas. Liquid and solid wastes must be disposed of properly and in compliance with MPCA regulations. A sign must be installed adjacent to each washout facility to inform concrete equipment operators to utilize the proper facilities. (Part IV.F.4)

# Chapter 4

## *Selected Required Activities During Construction*

### **Inspections and Maintenance**

Remember that if you are going to be in charge of inspecting and maintaining the BMPs, you need to have received appropriate training (Part III.A.Z.). Conduct routine inspections of the construction site and keep records of these inspections and maintenance performed (Part IV.E). Your SWPPP must identify who is responsible for conducting the inspections. You are required to inspect the construction site:

- Once every 7 days during active construction, AND
- Within 24 hours after a rainfall event greater than 0.5 inches in 24 hours. The next inspection must be conducted within 7 days after this.

In order to conduct inspections after a 0.5-inch rainfall event, you'll need to know how much rain falls on your site. The easiest way to do this is to install a rain gage at or near your construction site. Make sure nothing interferes with rainfall entering the rain gage (like a tree or building). Place the rain gage at the top of a stake or pole, and empty it after each rain event. Keep records of rainfall totals in your SWPPP.

You need to keep records of your inspections with your SWPPP, and your records must include a minimum set of information. The following information is required to be kept in your records:

- Date and time of inspections;
- Name of person conducting inspections;
- Finding of inspections, including corrective actions;
- Corrective actions taken (including dates, times, and party completing maintenance activities);
- Date and amount of all rainfall events greater than 0.5 inches in 24 hours; and
- Documentation of changes made to the SWPPP.

Use a camera during your inspections to document activities and any problems observed. Digital cameras can be especially convenient for this purpose.

An example *Maintenance Record* is provided as Attachment B. The MPCA has also developed an inspection log/calendar to assist in recording inspections. The inspection log/calendar can be found on the MPCA's construction stormwater Web page: [www.pca.state.mn.us/water/pubs/sw-insplog.pdf](http://www.pca.state.mn.us/water/pubs/sw-insplog.pdf)

Parts of the construction site that have undergone final stabilization may be inspected once per month. If work has been suspended due to frozen ground conditions, then required inspections must take place as soon as runoff occurs at the site or prior to resuming construction, whichever comes first.

## Records

The permit requires the owner to keep the SWPPP, all changes to it, and inspection and maintenance records at the construction site (Part III.D). You can keep the SWPPP in either a field office, or if a field office is not available, then in an on-site vehicle. An inspector will ask for your SWPPP, so make sure you keep it onsite at all times!

You must also keep the SWPPP and other records on file for three years after submittal of the NOT described in Chapter 5. In addition to the SWPPP, keep copies of any other permits required for the project, records of inspection and maintenance conducted, permanent operation and maintenance agreements that have been implemented, and required calculations for design of the temporary and permanent stormwater management systems.

As part of the SWPPP or with the SWPPP, you should keep training documentation that states the names of the people in charge of developing, implementing, overseeing, revising, and amending the SWPPP and the dates of training, name of instructors and the entity providing training and the content of training courses or workshops.

# *What Do I Have to Do When the Construction Project is Finishing?*

## **Final Stabilization**

The permit requires final stabilization of the construction site (Part IV.G). Final stabilization entails sections 1 through 5 or section 6:

1. Final Stabilization requires that all soil disturbing activities at the site have been completed and all soils are stabilized by any means necessary to prevent soil failure under erosive conditions or by a uniform perennial vegetative cover with a density of 70 percent over the entire pervious surface area. The density is based on canopy cover at 6” height. This includes sod that is firmly rooted to the underlying soil or direct-seeded herbaceous species that have grown to at least six inches in height. It does not include annual cover crop species such as oats and winter wheat. If soils are too poor to support 70 percent vegetative cover, the percent cover must be 70 percent of the native background vegetative cover, or other equivalent means necessary to prevent soil failure under erosive conditions.
2. You must ensure that the permanent stormwater treatment system meets all requirements in Part III, C. This includes but is not limited to, a final clean out of temporary or permanent sedimentation basins that are to be used as permanent water quality management basins and final construction or maintenance of infiltration basins. All sediment must be removed from conveyance systems and ditches must be stabilized with permanent cover.
3. A notice of termination (NOT) needs to be submitted to terminate the permit, but before that, all temporary synthetic and structural erosion prevention and sediment control BMPs (such as silt fence) must be removed on the portions of the site for which you are responsible. BMPs designed to decompose on site (such as some compost logs) may be left in place.
4. For residential construction only, individual lots are considered finally stabilized if the structure(s) are finished and temporary erosion protection and downgradient perimeter control has been completed and the residence has been sold to the homeowner. Additionally, you must distribute the MPCA’s “Homeowner Fact



Sheet” to the homeowner to inform the homeowner of the need for, and benefits of, permanent cover ([www.pca.state.mn.us/publications/wq-strm2-07.pdf](http://www.pca.state.mn.us/publications/wq-strm2-07.pdf)).

5. If your construction project was on land used for agricultural purposes, final stabilization may be accomplished by returning the disturbed land to its preconstruction agricultural use.
6. You may terminate permit coverage prior to completion of all construction activity if all of the following are met in addition to sections 2 and 3, and where applicable, section 4 or section 5.
  - construction activity has ceased for at least 90 days
  - at least 90 percent (by area) of all originally proposed construction activity has been completed and permanent cover has been established on those areas
  - on areas where construction activity is not complete, permanent cover has been established

## Notice of Termination

You must submit a notice of termination (NOT) by using the notice of termination/permit modification form to the MPCA to terminate coverage under this permit. The coverage terminates at midnight on the postmark date of on the date an on-line notice of termination/permit modification form is submitted to the MPCA.

A copy of the notice of termination/permit modification form is available from the MPCA Web site: [www.pca.state.mn.us/water/stormwater/stormwater-c.html](http://www.pca.state.mn.us/water/stormwater/stormwater-c.html).

There are three possible situations where coverage can be terminated.

The first situation arises when you want to terminate the coverage for the entire project, because, either Final Stabilization (page 28) has been achieved in all portions of the site or because the entire site has been sold; including roads and stormwater infrastructure and coverage has been transferred to another owner (Part II.B.5). In both cases a notice of termination/permit modification form must be submitted within 30 days of either the Final Stabilization or the sale of the site.

The second situation arises when you want to terminate coverage for a portion of the entire project that you have either sold or have legally transferred to another party and of which you are no longer the owner or operator. In this case, if construction activity is going to continue, you must submit a notice of termination/permit modification form within seven (7) days after the sale or legal transfer of the property. You must sign the notice of termination/permit modification form where appropriate and so does the new owner, who also needs to state contact information. Instructions on filling this form are available from the MPCA Web site:

[www.pca.state.mn.us/water/stormwater/stormwater-c.html](http://www.pca.state.mn.us/water/stormwater/stormwater-c.html).

The third situation arises when permit coverage was obtained using the subdivision registration process, in which case you are required to submit a permit termination/modification within 30 days after achieving final Stabilization (page 28).

If you use an alternative method for permanent stormwater management (described on page 21), then you cannot terminate the permit until final stabilization has been achieved on the site and you either have two years of monitoring data submitted to the MPCA showing that the required treatment has been achieved, or the MPCA determines that the alternative method is achieving the required treatment.

Finally, as a reminder, you must keep the SWPPP, inspection and maintenance records, permanent operation and maintenance agreements, and design calculations for at least three years after submitting the NOT/Permit Modification form.

# Chapter 6

## Resource Listing

The following are selected resources to help you develop and implement an effective SWPPP:

### **MPCA Stormwater Program**

[www.pca.state.mn.us/water/stormwater/index.html](http://www.pca.state.mn.us/water/stormwater/index.html)

Click on the construction stormwater program to get copies of the construction permit, application, and information on special waters, fact sheets, and staff contacts.

### **MPCA Minnesota Stormwater Manual**

[www.pca.state.mn.us/water/stormwater/stormwater-manual.html](http://www.pca.state.mn.us/water/stormwater/stormwater-manual.html)

An electronic copy of the MPCA's *Minnesota Stormwater Manual* v.2. (2008). The first part of the manual is dedicated to the management of stormwater in the context of Minnesota. The second part contains diagrams and formulae, helpful for professionals.

### **MPCA Stormwater BMP Manual**

[www.pca.state.mn.us/water/pubs/sw-bmpmanual.html](http://www.pca.state.mn.us/water/pubs/sw-bmpmanual.html)

An electronic copy of MPCA's *Protecting Water Quality in Urban Areas: Best Management Practices for Dealing with Stormwater Runoff from Urban, Suburban and Developing Areas of Minnesota* (2000). Includes information on all types of stormwater control practices.

### **Metropolitan Council's Urban Small Sites BMP Manual**

[www.metrocouncil.org/environment/Watershed/bmp/manual.htm](http://www.metrocouncil.org/environment/Watershed/bmp/manual.htm)

An electronic copy of the *Minnesota Urban Small Sites BMP Manual: Stormwater Best Management Practices for Cold Climates* (2001). This BMP manual provides information on construction and permanent stormwater BMPs.

### **Minnesota Erosion Control Association**

[www.mnerosion.org](http://www.mnerosion.org) - An organization advancing effective stormwater management and erosion and sediment control techniques and practices.

### **International Erosion Control Association**

[www.ieca.org](http://www.ieca.org) - An association for erosion and sediment control professionals

## Definitions

The following selected definitions are reprinted from MPCA’s construction permit. For additional definitions, refer to the permit.

**“Best Management Practices (BMPs)”**

Erosion prevention and sediment control and water quality management practices that are the most effective and practicable means of controlling, preventing, and minimizing degradation of surface water, including avoidance of impacts, construction-phasing, minimizing the length of time soil areas are exposed, prohibitions, and other management practices published by state or designated area-wide planning agencies. Individual BMPs found in the construction permit are described in the current version of *Protecting Water Quality in Urban Areas*, Minnesota Pollution Control Agency 2000. BMPs must be adapted to the site and can be adopted from other sources. However, they must be similar in purpose and at least as effective and stringent as MPCA’s BMPs. (Other sources include manufacturers specifications, *Stormwater Management for Construction Activities: Developing Pollution Prevention Plans and Best Management Practices*, U.S. Environmental Protection Agency 1992, and *Erosion Control Design Manual*, Minnesota Department of Transportation, et al, 1993).

**“Common Plan of Development or Sale”**

A contiguous area where multiple separate and distinct land disturbing activities may be taking place at different times, on different schedules, but under one proposed plan. One plan is broadly defined to include design, permit application, advertisement or physical demarcation indicating that land-disturbing activities may occur.

**“Construction Activity”**

Construction activity as defined in 40 C.F.R. part 122.26(b)(14)(x) and small construction activity as defined in 40 C.F.R. part 122.26(b)(15). This includes a disturbance to the land that results in a change in the topography, existing soil cover (both vegetative and non-vegetative), or the existing soil topography that may result in accelerated stormwater runoff, leading to soil erosion and movement of sediment into surface waters or drainage systems. Examples of construction activity may include clearing, grading, filling and excavating. Construction activity includes the disturbance of less than one acre of total

land area that is a part of a larger common plan of development or sale if the larger common plan will ultimately disturb one acre or more.

**“Erosion Prevention”**

Measures employed to prevent erosion including but not limited to: soil stabilization practices, limited grading, mulch, temporary erosion protection or permanent cover, and construction phasing.

**“Final Stabilization”** means that either:

- a. All soil disturbing activities at the site have been completed and a uniform (evenly distributed, without large bare areas) perennial vegetative cover with a density of 70% of the native background vegetative cover for the area has been established on all unpaved areas and areas not covered by permanent structures, or equivalent permanent stabilization measures (such as the use of riprap, gabions, or geotextiles) have been employed;
- b. For individual lots in residential construction by either: (a) The homebuilder completing final stabilization as specified above, or (b) the homebuilder establishing temporary stabilization including perimeter controls for an individual lot prior to occupation of the home by the homeowner and informing the homeowner of the need for, and benefits of, final stabilization. (Homeowners typically have an incentive to put in the landscaping functionally equivalent to final stabilization as quick as possible to keep mud out of their homes and off sidewalks and driveways.); or
- c. For construction projects on land used for agricultural purposes (e.g., pipelines across crop or range land) final stabilization may be accomplished by returning the disturbed land to its preconstruction agricultural use. Areas disturbed that were not previously used for agricultural activities, such as buffer strips immediately adjacent to surface waters and drainage systems, and areas which are not being returned to their preconstruction agricultural use must meet the final stabilization criteria in (a) or (b) above.

**“National Pollutant Discharge Elimination System (NPDES)”**

The program for issuing, modifying, revoking, reissuing, terminating, monitoring, and enforcing permits under the Clean Water Act (Sections 301, 318, 402, and 405) and United States Code of Federal Regulations Title 33, Sections 1317, 1328, 1342, and 1345.

**“Operator”**

The person (usually the general contractor), designated by the owner, who has day-to-day operational control and/or the ability to modify project plans and specifications related to the SWPPP. The person must be knowledgeable in those areas of the permit for which the operator is responsible (Part II.B. and Part IV.) and must perform those responsibilities in a workmanlike manner.

**“Owner”**

The person or party possessing the title of the land on which the construction activities will occur; or if the construction activity is for a lease, easement or mineral rights license



holder, the party or individual identified as the lease, easement or mineral rights license holder; or the contracting government agency responsible for the construction activity.

**“Permittee”**

A person(or persons), firm, or governmental agency or other institution that signs the application submitted to the MPCA and is responsible for compliance with the terms and conditions of the permit.

**“Sediment Control”**

Methods employed to prevent sediment from leaving the site. Sediment control practices include silt fences, sediment traps, earth dikes, drainage swales, check dams, subsurface drains, pipe slope drains, storm drain inlet protection, and temporary or permanent sedimentation basins.

**“Stormwater”**

Defined under Minn. R. 7077.0105, subp. 41(b), and includes precipitation runoff, stormwater runoff, snow melt runoff, and any other surface runoff and drainage.

**“Stormwater Pollution Prevention Plan” (SWPPP)**

A plan for stormwater discharge that includes erosion prevention measures, sediment controls and permanent stormwater management systems that, when implemented, will decrease soil erosion on a parcel of land and decrease off-site nonpoint pollution.

**“Surface Water or Waters”**

All streams, lakes, ponds, marshes, wetlands, reservoirs, springs, rivers, drainage systems, waterways, watercourses, and irrigation systems whether natural or artificial, public or private.

**“Temporary Erosion Protection”**

Methods employed to prevent erosion. Examples of temporary erosion protection include: straw, wood fiber blanket, wood chips, and erosion netting.

**“TMDL”**

The federal Clean Water Act requires states to adopt water quality standards to protect the nation’s waters. These standards define how much of a pollutant (Total Maximum Daily Load) can be in a surface and/or ground water while still allowing it to meet its designated uses, such as for drinking water, fishing, swimming, irrigation or industrial purposes. Many of Minnesota’s water resources cannot currently meet their designated uses because of pollution problems from a combination of point and nonpoint sources. TMDL projects are being implemented to address these impaired waters. The list of impaired waters is available at the MPCA Web site:

[www.pca.state.mn.us/water/tmdl/index.html](http://www.pca.state.mn.us/water/tmdl/index.html)

**“Waters of the State”**

Defined in Minn. Stat. § 115.01, subd. 22 as all streams, lakes, ponds, marshes, watercourses, waterways, wells, springs, reservoirs, aquifers, irrigation systems, drainage systems and all other bodies or accumulations of water, surface or underground, natural or artificial, public or private, which are contained within, flow through, or border upon the state or any portion thereof.



# Attachment A: Construction SWPPP Template

## Stormwater Pollution Prevention Plan (SWPPP) Template To comply with the General Stormwater Permit for Construction Activity (MN R100001)

*IMPORTANT:* Before completing this SWPPP, you must read and understand the requirements in the General Stormwater Permit for Construction Activity (MN R100001) available from MPCA at [www.pca.state.mn.us/water/stormwater/index.html](http://www.pca.state.mn.us/water/stormwater/index.html). An overview of the permit is available from MPCA at [www.pca.state.mn.us/publications/wq-strm2-05.pdf](http://www.pca.state.mn.us/publications/wq-strm2-05.pdf). This SWPPP Template will help you complete information required in Parts III and IV of the permit.

<b>Construction Activity Information</b>	
<b>Project Name</b>	
<b>Project Location</b>	
Briefly describe where construction activity occurs. Include address if available	
City or Township	State, Zip Code MN
Latitude and longitude of approximate centroid of project	
Method of collection of latitude/longitude: GPS    Online tool    USGS Topographic map Scale used (refer to topographic map)	
All cities where construction will occur	
All counties where construction will occur	All townships where construction will occur



<b>Project Size (number of acres to be disturbed)</b>			
<b>Project Type</b>			
<input type="checkbox"/> Residential	<input type="checkbox"/> Commercial/Industrial	<input type="checkbox"/> Road Construction	
<input type="checkbox"/> Residential and Road Construction	<input type="checkbox"/> Other (describe)		
<b>Cumulative Impervious Surface</b>			
Existing area of impervious surface _____ (to the nearest quarter acre)			
Post construction area of impervious surface _____ (to the nearest quarter acre)			
<b>Receiving Waters</b>			
Name of Water Body	Type (ditch, pond, wetland, lake, stream, river)	Special Water? (See Stormwater Permit Appendix A)	Impaired Water?*** (See Stormwater Permit Appendix A)
		<input type="checkbox"/> Yes <input type="checkbox"/> No	<input type="checkbox"/> Yes <input type="checkbox"/> No
		<input type="checkbox"/> Yes <input type="checkbox"/> No	<input type="checkbox"/> Yes <input type="checkbox"/> No
		<input type="checkbox"/> Yes <input type="checkbox"/> No	<input type="checkbox"/> Yes <input type="checkbox"/> No
		<input type="checkbox"/> Yes <input type="checkbox"/> No	<input type="checkbox"/> Yes <input type="checkbox"/> No
* Impaired water for the following pollutant(s) or stressor(s): phosphorus, turbidity, dissolved oxygen, or biotic impairment			
<b>Dates of Construction</b>			
Construction Start Date		Estimated Completion Date	





<b>Contact Information</b>				
<b>Owner of the Site</b>				
Business of Firm Name				
Last Name	First Name	Title	E-mail	Telephone ( <i>include area code</i> )
Mailing Address			City	State Zip Code
Alternate Contact Last Name		First Name	E-mail	Telephone ( <i>include area code</i> )
<b>Contractor (Person who will oversee implementation of the SWPPP)</b>				
Business of Firm Name				
Last Name	First Name	Title	E-mail	Telephone ( <i>include area code</i> )
Mailing Address			City	State Zip Code
Alternate Contact Last Name		First Name	E-mail	Telephone ( <i>include area code</i> )
<b>Party Responsible for Long Term Operation and Maintenance of the Permanent Stormwater Management System</b>				
Business of Firm Name				
Last Name	First Name	Title	E-mail	Telephone ( <i>include area code</i> )
Mailing Address			City	State Zip Code
Alternate Contact Last Name		First Name	E-mail	Telephone ( <i>include area code</i> )



<b>General Construction Project Information</b>
Describe the construction activity (what will be built, general timeline, etc.)
Describe soil types found at the project.

<b>General site information (III.A)</b>
Describe the location and type of all temporary and permanent erosion prevention and sediment control BMPs. Include the timing for installation and procedures used to establish additional temporary BMPs as necessary. (III.A.4.a)
Attach to this SWPPP a table with the anticipated quantities for the life of the project for all erosion prevention and sediment control BMPs (III. A. 4.b)
<p>Attach to this SWPPP a site map that includes the following features (III.A.3.b – f):</p> <ul style="list-style-type: none"> <li>• Existing and final grades, including dividing lines and direction of flow for all pre and post-construction stormwater runoff drainage areas located within the project limits.</li> <li>• Locations of impervious surfaces and soil types.</li> <li>• Locations of areas not to be disturbed.</li> <li>• Location of areas of phased construction</li> <li>• All surface waters and existing wetlands within 1mile from the project boundaries that will receive stormwater runoff from the site (identifiable on maps such as USGS 7.5 minute quadrangle maps or equivalent). Where surface waters receiving runoff associated with construction activity will not fit on the plan sheet, they must be identified with an arrow, indicating both direction and distance to the surface water.</li> <li>• Methods to be used for final stabilization of all exposed soil areas.</li> </ul>
Were stormwater mitigation measures required as the result of an environmental, archaeological, or other required local, state, or federal review of the project? If yes, describe how these measures were addressed in the SWPPP. (III.A.6.)



Is the project located in a karst area such that additional measures would be necessary to protect drinking water supply management areas as described in Minn. R. chapters 7050 and 7060? If yes, describe the additional measures to be used. (III.A.7.)

Does the site discharge to a calcareous fen listed in Minn. R. 7050.0180, subp. 6.b.? If yes, a letter of approval from the Minnesota Department of Natural Resources must be obtained prior to application for this permit. (Part I B.6 and Part III.A.8)

Does the site discharge to a water that is listed as impaired for the following pollutant(s) or stressor(s): phosphorus, turbidity, dissolved oxygen or biotic impairment? Use the Special and Impaired Waters Search Tool at: [www.pca.state.mn.us/water/stormwater/stormwater-c.html](http://www.pca.state.mn.us/water/stormwater/stormwater-c.html). If no, skip to next box.

Does the Impaired water have an approved TMDL with an Approved Waste Load Allocation for construction activity? If yes:

- List the receiving water, the areas of the site discharging to it, and the pollutant(s) identified in the TMDL.
- List the BMPs and any other specific construction stormwater related implementation activities identified in the TMDL.

If the site has a discharge point within one mile of the impaired water and the water flows to the impaired water but no specific BMPs for construction are identified in the TMDL, the additional BMPs in Appendix A (C.1 and C.2) must be added to the SWPPP and implemented. (III.A.7). The additional BMPs only apply to those portions of the project that drain to one of the identified discharge points.

### Training (III.A)

Training is required for all permitted projects after February 1, 2010. It must be provided by entities with expertise in erosion prevention, sediment control or permanent stormwater management. Training must be focused on the individual's job duties as they relate to the permit requirements (Part III.A.2). Who must be trained?

- ✓ Individual(s) preparing the SWPPP for the project
- ✓ Individual(s) overseeing the implementation of, revising and amending the SWPPP and individuals performing inspections required by the permit
- ✓ Individuals performing or supervising the installation, maintenance or repair of BMPs

Attach to this SWPPP:

Names of the personnel trained; dates of training; name of instructor(s) and entity providing training; content of training course or workshop (including number of hours of training).

### Selection of a Permanent Stormwater Management System (III.C)

Will the project create a new cumulative impervious surface greater than or equal to one acre?

Yes     No

If yes, a water quality volume of ½ inch of runoff from this area must be treated before leaving the site or entering surface waters (1 inch if discharging to special waters).

Describe which method will be used to treat runoff from the new impervious surfaces created by the project (III.C):

- Wet sedimentation basin
- Infiltration/Filtration
- Regional ponds
- Combination of practices

Include all calculations and design information for the method selected. See Part III.C of the permit for specific requirements associated with each method.

If it is not feasible to meet the treatment requirement for the water quality volume, describe why. This can include proximity to bedrock or road projects where the lack of right of way precludes the installation of any permanent stormwater management practices. Describe what other treatment, such as grasses swales, smaller ponds, or grit chambers, will be implemented to treat runoff prior to discharge to surface waters. (III.C)

If proposing an alternative method to treat runoff from the new impervious surfaces, describe how this alternative will achieve approximately 80% removal of total suspended solids on an annual average basis (III.C.5). NOTE: If proposing an alternative method, you must submit your SWPPP to MPCA at least 90 days prior to the starting date of the construction activity.

### **Erosion Prevention Practices (IV.B)**

Describe construction phasing, vegetative buffer strips, horizontal slope grading, and other construction practices to minimize erosion. Delineate areas not to be disturbed (e.g., with flags, stakes, signs, silt fence, etc.) before work begins.

Describe temporary erosion protection or permanent cover used for exposed soil. All exposed soil areas must be stabilized as soon as possible but in no case later than 14 days after the construction activity in that portion of the site has temporarily or permanently (part IV.B.2)



For drainage or diversion ditches, describe practices to stabilize the normal wetted perimeter within 200 lineal feet of the property edge or point of discharge to surface water. The remaining portions of the temporary or permanent ditch or swale must be stabilized within 14 days after connecting to surface waters and construction in that portion of the ditch has temporarily or permanently ceased.

Describe other erosion prevention practices (list and describe).

### **Sediment Control Practices (IV.C)**

Describe sediment control practices used to minimize sediments from entering surface waters, including curb and gutter systems and storm drain inlets. At a minimum, these sediment control practices must include:

- Sediment controls for temporary or permanent drainage ditches and sediment basins that are designed as part of a treatment system
- Installation of check dams or other grade control practice to ensure sheet flow and prevent rills (for slope lengths greater than 75 feet with a grade of 3:1 or steeper).
- Sediment control practices on all down gradient perimeters prior to land disturbing activities.
- Storm drain inlet protection for all inlets.
- Silt fencing or other sediment control surrounding temporary soil stockpiles.
- Minimize vehicle tracking of sediments (e.g., stone pads, concrete or steel wash racks, or equivalent systems).
- Street sweeping of tracked sediment.
- Temporary sedimentation basins (see Part III.B).

### **Dewatering and Basin Draining (IV.D)**

Will the project include dewatering or basin draining?    Yes    No

If yes, describe BMPs used so the discharge does not adversely affect the receiving water or downstream landowners.



**Additional BMPs for Special Waters and Discharges to Wetlands (Appendix A, Parts C and D)**

**Special Waters.** Does your project discharge to special waters?  Yes  No If no, skip to Wetlands section below.

If proximity to bedrock or road projects where the lack of right of way precludes the installation of any of the permanent stormwater management practices, then other treatment such as grassed swales, smaller ponds, or grit chambers is required prior to discharge to surface waters. Describe what other treatment will be provided.

Describe erosion and sediment controls for exposed soil areas with a continuous positive slope to a special waters, and temporary sediment basins for areas that drain 5 or more acres disturbed at one time.

Describe the undisturbed buffer zone to be used (not less than 100 linear feet from the special water).

Describe how the permanent stormwater management system will ensure that the pre and post project runoff rate and volume from the 1, and 2-year 24-hour precipitation events remains the same.

Describe how the permanent stormwater management system will minimize any increase in the temperature of trout stream receiving waters resulting in the 1, and 2-year 24-hour precipitation events.

**Wetlands.** Does your project discharge stormwater with the potential for significant adverse impacts to a wetland (e.g., conversion of a natural wetland to a stormwater pond)?  Yes  No

If Yes, describe the wetland mitigation sequence that will be followed in accordance with Part D of Appendix A.



**Inspections and Maintenance (IV.E)**

Describe procedures to routinely inspect the construction site:

- Once every seven (7) days during active construction and,
- Within 24 hours after a rainfall event greater than 0.5 inches in 24 hours, and within seven (7) days after that.

Inspections must include stabilized areas, erosion prevention and sediment control BMPs, and infiltration areas.

**Pollution Prevention Management Measures (IV.F)**

Describe practices to properly manage and dispose of solid waste, including trash (IV.F.1)

Describe practices to properly manage hazardous materials (IV.F.2).

Describe practices for external washing of trucks and other construction vehicles (IV.F.3)

Describe how are you going to provide a safe, leak proof, concrete washout on site (IV.F.4):

Describe your spill prevention plan.



Describe measures to address sanitary and septic waste.

**Final Stabilization (IV.G)**

Describe how you will achieve final stabilization of the site (IV.G).

**Records Retention (III.D)**

Describe your record retention procedures (must be kept at the site) (III.D). Records must include:

- Copy of SWPPP and any changes
- Training documentation (III.A.2.)
- Inspection and maintenance records
- Permanent operation and maintenance agreements
- Calculations for the design of temporary and permanent stormwater management systems.





# Attachment B: Sample Maintenance Records

Inspector	Type of Inspection		Date of Inspection			Rainfall (record all events > 0.5 in)	Time of Inspection		Areas Inspected							Findings and Corrective Actions		
	Routine weekly	24 hrs after rain	Month	Day	Year		Time	AM	PM	Erosion / Sediment Control BMPs	Silt Fences	Sedimentation basins	Drainage ditches and other surface waters	Construction site exits	Infiltration areas			Pollution Prevention Measures
																	Findings:	Corrective Actions:
																	Findings:	Corrective Actions:
																	Findings:	Corrective Actions:
																	Findings:	Corrective Actions:
																	Findings:	Corrective Actions:
																	Findings:	Corrective Actions:
																	Findings:	Corrective Actions:
																	Findings:	Corrective Actions:
																	Findings:	Corrective Actions:



## Stormwater Pollution Prevention Plan

### NPDES/SDS Construction Stormwater permit requirements

This fact sheet provides guidance on writing an adequate Stormwater Pollution Prevention Plan (SWPPP) that will assist in keeping a construction site in compliance with the National Pollutant Discharge Elimination System (NPDES)/State Disposal System (SDS) Construction Stormwater (CSW) permit. The development of a proper SWPPP is a requirement of the permit and the responsibility of the owner.

### What is a Stormwater Pollution Prevention Plan?

A SWPPP is a plan that describes the strategies and steps that will be taken to prevent nonpoint source pollution discharging from a construction site. The SWPPP is a valuable tool and will become the backbone of the entire construction process related to erosion and sediment control and stormwater management, both during construction and post construction. The SWPPP includes a description of all construction activity, temporary and permanent erosion and sediment control BMPs, permanent stormwater management, and other pollution prevention techniques to be implemented throughout the life of the construction project. The SWPPP includes a combination of narrative plans and standard detail sheets that address the foreseeable conditions at any stage of construction.

### Why do I need a Stormwater Pollution Prevention Plan?

All construction projects disturbing one acre or more or that are part of a larger common plan of development that ultimately disturbs one acre or more are required to apply for an NPDES/SDS Construction Stormwater permit through the Minnesota Pollution Control Agency (MPCA). The permit states that prior to submitting a permit application, the owner must develop a SWPPP for the construction site. The SWPPP is the plan developed by and for the permittees addressing how they are to meet the requirements and conditions of the CSW general permit specifically for their site. Site conditions, soil types and expected precipitation will be different for each site and the permittee must select the best and cost effective best management practices (BMPs) and installation locations for their particular site. The SWPPP is to be kept at the site for the duration of the project and retained in files for three years after the project is completed. If the construction project disturbs 50 acres or more and discharges to a special or impaired water, the SWPPP must be submitted along with the permit application to the MPCA 30 days prior to the start of any construction activity.



Planning ahead is the most effective way to minimize erosion and sedimentation during construction and reduce project costs.

### How is a Stormwater Pollution Prevention Plan helpful to me?

A successful SWPPP identifies the issues of concern before construction begins and is also adaptable for the many unexpected changes that come about with every construction project. Planning ahead is the most effective way to minimize erosion and sedimentation during construction and reduce project costs. A well organized and planned out SWPPP will assist in the prevention of unnecessary permit violations and save the owner and contractor time, money, and effort over the course of the project.

## What are the necessary components of a Stormwater Pollution Prevention Plan?

The NPDES/SDS Construction Stormwater permit outlines specific requirements of a SWPPP. In order to develop a truly effective and useful SWPPP, it is important to carefully think about each of these requirements and to clearly document a plan for the construction project.

The Owner must identify a trained individual to oversee implementation of the SWPPP, including inspections and maintenance activities required by the permit. Also, the person preparing the SWPPP must be knowledgeable of the permit requirements and trained in preparation of SWPPPs.

The SWPPP must include the following components:

- A description of the construction activities and the potential for sediment and other pollutant discharges from the site.
- Maps showing the locations of all surface waters, including wetlands, stormwater ponds or basins within one mile of the site.
- Areas of the site that will drain to a public water the Department of Natural Resources has promulgated “work in water restrictions” for fish spawning timeframes.
- A determination whether surface waters within one mile of the site are special or impaired for one of the construction-related parameters and additional or enhanced BMPs that will be utilized to address the special or impaired waters.
- Stormwater pollution mitigation measures to be utilized as a result of an environmental review.
- Additional measures needed at the site to address karst or drinking water supply management areas.
- Training documentation for all individuals required to be trained in associated duties in regard to the SWPPP.
- A site map showing both the existing and final grades, including direction of flow and pre and post drainage area divides. The site map must also include locations of steep slopes, impervious surfaces, soil types, and pollutant-generating activities (building products, pesticides, herbicides, fertilizer, treatment chemicals, hazardous materials, solid waste, portable toilets, etc.).
- Estimated quantities of all erosion prevention and sediment control BMPs to be used for the life of the project.
- Stormwater design specifications and calculations for stormwater management systems, including the number of acres of existing and new impervious surfaces.
- The following factors must be accounted for in design of BMPs to be used at the site:
  - the amount, frequency, intensity and duration of precipitation
  - stormwater runoff and run-on and expected flow from impervious surfaces
  - slope lengths and steepness, the site location and drainage features
  - flow rate and volume of channelized flow
  - soil types
- Timing of installation for all erosion prevention and sediment control BMPs and permanent stormwater management systems.
- Location and type of all permanent and temporary erosion prevention and sediment control BMPs to be installed at the site along with procedures to establish additional BMPs as necessary.
- A description of methods to be used for site dewatering and basin draining.
- Areas not to be disturbed on the site, including the location of buffer zones.
- Locations of areas to be phased to minimize duration of exposed soils.
- Methods to minimize soil compaction and preserve top soil at the site.
- Methods used to achieve final stabilization.

- Documentation why certain design requirements or SWPPP components are not feasible and the methods to be substituted as allowable by the permit.
- A maintenance plan for permanent stormwater treatment systems, including who will maintain the system.
- A description of pollution prevention measures for storage, handling and disposal of hazardous materials, solid waste, concrete and equipment wash water, portable toilets, construction products and materials.
- Plans for proper use of sediment treatment chemicals (polymers, flocculants, etc.).
- A description of inspection and maintenance activities and record keeping.
- Procedures for terminating permit coverage.

Please refer to the NPDES/SDS General Construction Stormwater permit for more complete details on SWPPP content.

## Changes and revisions to the Stormwater Pollution Prevention Plan

The NPDES/SDS Construction Stormwater permit requires that the SWPPP be developed prior to the start of a construction project. It is often difficult to fully plan ahead and more often than not, unexpected changes arise throughout the duration of the project. For this reason, the SWPPP is a flexible and amendable document. It is a living document that should be revised as the project changes and should be used to document all project modifications. The SWPPP is also amended whenever:

- Design, construction, operation, maintenance, weather or seasonal conditions will affect the performance of BMPs and potential for discharge of pollutants at the site.
- Site inspections indicate the BMPs are not effective in minimizing discharges.
- An MPCA inspector determines the project discharges have the potential to violate a water quality standard.
- It is determined the SWPPP is not consistent with the terms and conditions of the permit.

In the case of a change in property ownership, any new owner is required to have an up to date and complete SWPPP. The new owner can modify the original SWPPP or develop a new SWPPP that covers all information required by the permit.

## Resources

Minnesota Stormwater Manual

[http://www.pca.state.mn.us/index.php?option=com\\_k2&view=item&id=993](http://www.pca.state.mn.us/index.php?option=com_k2&view=item&id=993)

MPCA SWPPP checklist

<http://www.pca.state.mn.us/index.php/view-document.html?qid=15629>

MPCA stormwater compliance assistance tool kit for small construction operators

[www.pca.state.mn.us/publications/wq-strm2-09.pdf](http://www.pca.state.mn.us/publications/wq-strm2-09.pdf)

MPCA General Construction Stormwater permit for construction activity

<http://www.pca.state.mn.us/water/stormwater/stormwater-c.html>

MPCA construction SWPPP Template A [www.pca.state.mn.us/publications/wq-strm2-12.pdf](http://www.pca.state.mn.us/publications/wq-strm2-12.pdf)



The NPDES permit requires that all erosion and sediment BMPs be clearly outlined in a site's SWPPP. Changes made throughout construction should be documented in the SWPPP.

Image Courtesy of Emmons & Olivier Resources, Inc.



## Construction Stormwater Permit

### Training requirements

Since March of 2003, the federal Phase II National Pollution Discharge Elimination System (NPDES) stormwater regulations have required all construction projects disturbing one or more acres of land to obtain an NPDES/State Disposal System General Stormwater Permit for Construction Activity (Permit). The Permit has many requirements regarding Best Management Practices (BMPs) for erosion prevention and sediment control in addition to requirements for permanent, post-construction stormwater-treatment systems.

The NPDES/SDS Construction Stormwater CSW General Permit requires training for personnel implementing permit requirements on construction sites. An update refresher-training must be attended every three (3) years starting three (3) years from the August 1, 2013, re-issuance date of the CSW permit.

### Who must be trained?

The owner of the project must ensure that training has been received by individuals who are:

- Individuals preparing the SWPPP (typically the project engineer or consultant). Stormwater Pollution Prevention Plans (SWPPPs) must be developed prior to construction that describes the measures to be implemented during construction projects in order to comply with the permit.
- Overseeing implementation of, revising, and amending the SWPPP and performing inspections as required in Part IV.E. (this may be the prime contractor, site manager or foreman).
- Performing or supervising the installation, maintenance and repair of erosion and sediment control BMPs (crew supervisor or laborer)

### Length of training

The minimum amount of training to perform these job duties for the majority of projects should be as follows:

Category 1: (SWPPP designer) 12-14 hours

Category 2: (site manager) 10-12 hours

Category 3: (BMP installer) 5-8 hours

## Training content

The content and extent of training must be commensurate with an individual's job responsibilities with regard to activities covered under the permit for the project. For example, if an individual's only job is to conduct dewatering activities at sites, then the training may be limited to that one particular activity. However, for most individuals identified in the permit, the training must be more comprehensive.

A project may have many individuals with varying levels of responsibility; however, most should fit within one of the three groups listed above. If an individual's job responsibility is identified under one of the categories listed below, the training must include information regarding that specific duty. For certain projects, there may be other duties related to stormwater management that are not identified on the listed categories and the training must include those subjects.

Because each state issues an NPDES construction stormwater permit, specific requirements may vary, even if all have similar goals regarding proper stormwater management during construction. Training does not need to be specific to the Minnesota permit, however, all personnel that are required to have training are expected to know the specific permit requirements for the state of Minnesota. Therefore, it is important to read and understand the permit and related guidance found on the MPCA's Construction Stormwater webpage: <http://www.pca.state.mn.us/water/stormwater/stormwater-c.html>.

## Stormwater Pollution Prevention Plan designer training requirements

Training content must include the following as it applies to an individual's job duties under the permit. Training for individuals preparing the Stormwater Pollution Prevention Plan (SWPPP) must include the following topics:

- understanding the environmental impacts of construction activity
- general NPDES permit requirements including erosion prevention and sediment control BMPs
- dewatering requirements
- chemical treatments and their requirements
- recordkeeping requirements (inspections, BMP maintenance, SWPPP amendments)
- pollution prevention measures regarding storage and handling of construction products, materials and wastes; including solid wastes, hazardous wastes, sanitary wastes, petroleum products, herbicides and fertilizers, wash water from concrete pouring or equipment washing
- estimated preliminary material quantities tabulation
- fueling planning and spill prevention and response procedures use of contracts for delegating SWPPP responsibility
- understanding that in some states the requirements may be different when discharging to certain waters
- construction phasing
- readable and effective plans
- specification writing
- narrative writing
- understanding that local stormwater requirements may differ from state requirements
- low impact development (LID) innovations and new products
- permanent stormwater management requirements
- Total Maximum Daily Load (TMDL) and Special Waters requirements
- concrete washout facilities
- procedures for permit application, permit transfers and the notice of termination
- understanding Minnesota requirements for discharging to certain waters

The Construction Stormwater General Permit Part III.D7 requires post-construction stormwater-management systems to retain one inch of water volume from the new impervious surfaces to be constructed if the project is creating one or more acres of new impervious surfaces.

Whether the designer chooses to provide an infiltration basin or trench, rain gardens, filtration system, other volume reduction methods, etc. the permit has very specific design and sizing requirements for each. These systems are usually designed by a licensed Professional Engineer (P.E.), however, this is not required by the permit. In most cases a P.E. certification will still be needed in order to obtain a building permit or to fulfill other local requirements.

A well-designed functional stormwater treatment system contains design elements beyond the permit requirements. For example, for an infiltration basin (or rain garden) the permit specifies sizing requirements and some performance criteria but gives little information on how that can be accomplished successfully. Soil types must be checked, pre-treatment must be designed properly, construction techniques must be described in detail, and vegetation established at the end of infiltration basin construction. A trained individual must have enough engineering knowledge to understand the specific hydraulic design requirements set forth in the permit in addition to training that covers the additional specifics involved in a good design. Both of these elements are laid out in detail in the Minnesota Stormwater Manual: [www.pca.state.mn.us/water/stormwater/stormwater-manual.html](http://www.pca.state.mn.us/water/stormwater/stormwater-manual.html). Training must include detailed design examples similar to the examples found in the manual.

## Site manager training requirements

Training for contractors overseeing implementation of, revising, and amending the SWPPP and performing inspections must include the following topics:

- understanding the environmental impacts of construction activity
- general NPDES permit requirements including erosion prevention and sediment control
- dewatering requirements
- inspections and maintenance requirements and timeframes
- good housekeeping, how to handle trash, waste, and chemicals
- liability and consequences of enforcement
- contracts
- recordkeeping (inspections, BMP maintenance, SWPPP amendments)
- understanding that there is more than one solution to a problem, promote innovation
- reading plans and specifications
- risk management - taking initiative before bad things happen
- communication between site staff and subcontractors, dissemination of knowledge
- emergency response - weekends, storms, freezes, notification, reclamation of sediment plumes
- requirements regarding concrete washout facilities
- permit application process, permit transfers and the notice of termination
- local availability of specific erosion and sediment control BMPs
- BMPs
- installation
- maintenance (to repair, replace or if necessary upgrade to better BMPs)
- are they installed in correct location
- parking/access

Training should include many examples, group participation, and discussions. Field demonstrations may also be appropriate. Individuals who are considered trained must also be knowledgeable about requirements specific to the State of Minnesota.

Training for individuals performing or supervising the installation, maintenance, and repair of BMPs must include the following topics.

## **Best Management Practice installer training requirements**

The third category of individuals who are required to be trained are those who are physically installing the BMPs or supervising that activity. The type of training for this group may be highly specialized for a particular task or more encompassing for an individual who operates a full service erosion and sediment control business. Some of the typical BMPs that require installation by a trained individual include:

- silt fence
- dewatering
- mulch
- erosion control blankets
- ditch checks
- compost logs
- inlet protection
- hydro seeding or liquid soil stabilizers
- flocculants

## **Recommended training for construction-site owners and others**

Training is also recommended for owners of construction projects and for sub-contractors that have the potential to inadvertently cause or contribute to violation of the permit. This training is not required by the permit; it can, however, be extremely beneficial to site owners.

A site owner should be aware of the basic requirements within the permit and understand that enforcement actions can result if a site is found out of compliance. Owners should understand the potential for environmental harm that exists during a typical construction project. Other topics owners should be aware of include:

- application procedure
- how to transfer a permit if a portion of a project is sold
- liability and consequences of enforcement
- notice of permit termination requirements
- SWPPP basics
- erosion prevention and sediment control basics
- dewatering requirements
- good housekeeping, how to properly handle trash, waste and chemicals
- local requirements
- role of post-construction stormwater treatment systems
- potential value of LID or conservation design methods
- costs and bidding concepts
- contracts
- temporary BMP inspection and maintenance requirements



There are also subcontractors that should be aware of certain permit requirements. Owners are advised to inform anyone on site about the presence of erosion and sediment control BMPs. For example, an operator delivering building supplies should know what a silt fence is and understand that it is a Permit violation to damage the fence and not repair or replace it. Another example: owners are required to provide a leak proof system to be used for concrete washout and concrete truck operators should understand that a site has such a facility and concrete washout activities can only occur using the washout system.

## Where training is available

The training must be obtained from local, state, federal agencies, professional organizations, or other entities with expertise in erosion prevention, sediment control, or permanent stormwater management. It is required by the Permit that at least one trained individual responsible for implementing and revising the SWPPP must be present on the site or available for an onsite inspection within 72 hours. The MPCA has partnered with the University of Minnesota for the past five years to provide various certification courses for individuals working within the stormwater program. These certification courses are also sponsored by the Minnesota Department of Transportation (MnDOT) and are required for those individuals working on MnDOT projects.

There are currently three different classes targeted at the three different categories of individuals required to obtain the training outlined in the permit.

These include Installer, Site Management and Design of Stormwater Pollution Prevention Plans. When selecting a class be sure to select the class that best fits your role. For example SWPPP designers should enroll in the SWPPP design course while a site foreman in charge of the day-to-day activities in the field should take the site-management course. In order to remain certified for work on MnDOT projects, the course must be repeated every three years. As of issuance of the August 1, 2013 the NPDES/SDS Construction Stormwater permit, the training must be updated at least once every three years starting three years after the issuance date of the permit. The classes generally run through the fall, winter and early spring. More information and a class schedule can be found at: [www.erosion.umn.edu](http://www.erosion.umn.edu).

Other training opportunities exist and there are qualified individuals offering training. If you have received training in another state, it may satisfy the training requirements if the course curriculum was adequate and the individual has familiarized themselves with the specific requirements in the Minnesota NPDES/SDS permit.

When selecting training courses or reviewing your past training, be sure to review the course content and verify that it meets all of your SWPPP-related duties. Regardless of the source of the training, a refresher course must be taken every three years and documentation of the training must be available and provided upon request of the MPCA or owner of the project.

Training should be provided by instructors with some background in education methods. Individuals that are widely accepted as experts in erosion control or SWPPP design, and who have provided training in the past, are considered trained for the purposes of this construction permit. These individuals usually have ten or more years of experience in the field.

Other entities that may offer training opportunities include:

- the University of Minnesota
- the Minnesota Erosion Control Association
- private industries
- other local, state, federal agencies, professional organizations, or other entities with expertise in erosion prevention, sediment control or permanent stormwater management
- the Minnesota Utility Contractors Association offers trade specific training. Information on training opportunities can be found at: [www.muca.org](http://www.muca.org).
- Training is also available at the Minnesota Laborers Training Center; training schedules can be found at: [www.ltcmn.org/](http://www.ltcmn.org/).

## Nationally recognized certifications

There are other nationally recognized certification programs regarding construction stormwater. These certifications include Certified Professional in Erosion Sediment Control (CPESC), Certified Professional in Storm Water Quality (CPSWQ) and Certified Erosion Sediment and Storm Water Inspector (CESSWI).

These certifications may fulfill the training requirements if the individual is knowledgeable about the stormwater requirements that are specific to the state of Minnesota and the content of the certification covers all of the individual's responsibilities regarding the permit. For example, an individual that holds a CPESC certification may be considered trained as a site manager, but would not be considered a trained SWPPP designer if the SWPPP was required to have stormwater treatment systems constructed such as rain gardens or detention basins as the CPESC course does not cover those topics.

Likewise, a professional engineer is not considered trained to design an entire SWPPP as the typical engineering curriculum does not cover any erosion prevention or sediment control techniques. However a P.E. would be considered trained to design the permanent stormwater treatment system as the sizing and hydrology principals are a part of the engineering curriculum, if the individual is knowledgeable about the stormwater requirements that are specific to the state of Minnesota.

## Documentation of training

The permit requires that documentation of the individuals working on a project be documented in the SWPPP or made available within 72 hours upon request by the MPCA. Documentation must include:

- names of the personnel associated with this project that are required to be trained
- dates of training and names of instructor(s) and entity that provided training
- content of training course or workshop (including the number of hours of training)

## More information

If you have questions, call the MPCA Stormwater Program at 651-757-2119 or 800-657-3804.



## Linear Utility Projects

### Guidance Regarding National Pollutant Discharge Elimination System/ State Disposal System Construction Stormwater Permit Requirements

Use this guidance to determine whether a National Pollutant Discharge Elimination System/State Disposal System (NPDES/SDS) construction stormwater permit is needed for your linear underground/overhead project. Linear facilities include conduits, substructures, pipelines, towers, poles cables, wires, connectors, switching, regulating and transforming equipment, and associated ancillary facilities.

### Background

Construction activities including clearing, grading, and excavating that will disturb one or more acres of land, or that are part of a larger common plan of development or sale that will disturb one or more acres of land, requires coverage under a NPDES/SDS construction stormwater permit.

### How do I determine land disturbance area for my linear project?

Depending on the project type, to determine if the land area to be disturbed will be one acre or more, include the following areas in calculating the disturbed area:

- Surface areas of trenches and associated laterals. Backhoe or trencher work, including excavation width and stockpile area, and vehicle width if soil will be exposed during operation. The area of trenching impact should be determined by the width of trench, side casted material pile, and depending on level of disturbance, the width of the installation equipment. Trench spoils on a paved surface that are either returned to the trench or excavation or hauled away from the project daily for disposal or reuse are not included in the disturbed area calculation.
- Soil areas outside the surface area of trenches, laterals, and ancillary facilities that will be graded or disturbed by the use of construction equipment, vehicles, and machinery during construction activities. This includes tracked vehicles that cause rutting that disturbs the vegetative cover exposing soil the length of a vehicle traverse. (In general, work with tracked vehicles can result in minimal soil disturbance, as long as slope, soils, and weather are favorable).
- Surface area of soil stockpiles located onsite or immediately adjacent to the project if the stockpile is not on a paved surface.
- Surface area of borrow areas located onsite or immediately adjacent to the project.
- Surface area of structure installation and other ancillary facilities (e.g. poles, pull boxes, fuse boxes, splice boxes, pads, etc.).
- Paved surface areas constructed for the purpose of the project.
- New roads constructed or major reconstruction to existing roads (e.g. improvements to two-track surfaces or road widening) for the purpose of accessing construction activities or as part of the final project.
- Staging, preparation, equipment and material storage areas not on paved surfaces.

## How do I determine if my linear project is part of a common plan?

A common plan of development or sale means a contiguous area where multiple, separate and distinct land disturbing activities may be taking place at different times, on different schedules, under one proposed plan. A "common plan" may consist of non-contiguous separate projects. In this case, for discrete construction projects that are located within a larger common plan that are at least one fourth mile apart, each project (e.g. individual structure) can be treated as a separate plan of development or sale provided no land disturbing activity is proposed between the projects.

*Example:* Two oil and gas well pads separated by one half mile could be treated as separate development plans if no land disturbing activity is proposed between the pads. However, if the same two well pads are connected by an access road or other land disturbing activity, all three areas would be considered part of a "common plan" for permitting purposes even if the construction activity is occurring at separate times.

*Example:* If a utility company were constructing new trunk lines off an existing transmission line to serve separate residential subdivisions located more than one fourth mile apart, the two trunk line projects could be considered to be separate projects

## What if conditions change during construction and the disturbed area is greater than originally estimated?

If you originally determined that NPDES/SDS construction stormwater permit coverage was not required for your project, appropriate best management practices (BMPs) should be used for erosion prevention and sediment control to avoid transport of sediment and associated contaminants that would violate water quality standards downstream from the project area during project construction.

During dry or frozen ground conditions with snow cover, soil disturbance from installation of linear facilities is generally expected to be minimal. Under these conditions, the need for BMPs is dependent on the proximity of the project to waters of the state, the amount of soil disturbance, and the potential to violate state water quality standards during construction.

However, if unexpected rainfall or wet soil conditions occur that will result in larger exposure of soil, one acre or more, or your area of disturbance is greater than you originally calculated, you will need to meet the requirements for permit application and obtain NPDES/SDS construction stormwater permit coverage.

## What is required for linear projects and wetlands?

The project should be in compliance with state and federal wetland regulations, including the Minnesota Wetland Conservation Act, and Section 404 of the Clean Water Act, as applicable.

## Application materials

To get an application form and find more information about applying for permit coverage, visit the Minnesota Pollution Control Agency (MPCA) construction stormwater website at:

[www.pca.state.mn.us/water/stormwater/stormwater-c.html](http://www.pca.state.mn.us/water/stormwater/stormwater-c.html).

## **Construction Stormwater Training opportunities for utility projects**

The Minnesota Utility Contractors Association offers trade specific training on erosion and sediment control at utility construction sites. Information on training opportunities can be found at: [www.muca.org](http://www.muca.org).

### **More information**

#### **MPCA Stormwater Hotline**

651-757-2119

800-657-3804 (toll free)



Minnesota  
Pollution  
Control  
Agency

# Emergency Construction Stormwater Application

## Overview

---

wq-strm2-32 • February 26, 2009

**E**mergency construction that is required to minimize the impacts of an emergency situation, in certain cases, does not require an application to be submitted to the Minnesota Pollution Control Agency (MPCA) in order to receive Construction Stormwater Permit coverage.

### Notification

In emergency situations, small construction activities that disturb one to less than five acres may begin immediately after the MPCA is notified with basic site information including:

- Contact name/owner's name
- Name/address of the construction company
- Location/address of the construction activity
- List of the cities, counties, and townships where the construction activity is occurring
- The approximate acres to be disturbed by the construction activity
- A brief description of the emergency situation

### How to contact MPCA

Emergency construction notification to the MPCA must be done through letter, telephone, or by facsimile.

### Mailing address

Construction Stormwater Program  
Minnesota Pollution Control Agency  
520 Lafayette Road North  
St. Paul, MN 55155

### Stormwater Program phone

651-757-2119 or toll-free at 800-657-3804  
(leave message after hours)

### Stormwater Program fax

651/297-8683

### Requirements

Under the federal rule, National Pollutant Discharge Elimination System (NPDES) Construction Stormwater Permit coverage for stormwater discharges associated with construction activity is required before the start of construction.

However, emergency situations often arise where immediate action is required to restore utility related services such as gas, or electricity or other essential public services including public transportation systems such as airports and roadways. These emergency situations may be the result of natural disasters or failures of systems unrelated to the utility operation and, therefore, may require immediate construction of emergency access, diversionary or replacement structures, or other types of activities

The MPCA has developed some flexibility in meeting the Construction Stormwater Permit application requirements when construction activities must begin

immediately to minimize the impacts of an emergency situation.

Minn. R. 7090.2020, subparts 1 and 2 - *Scope and Emergency* construction allow emergency construction resulting from natural disasters such as floods, tornados, and severe storms that present an imminent threat to public health and safety, public drinking water or the environment to begin without permit application, if the following specific requirements are met:

- The owner must notify the MPCA that emergency construction activities will begin. This is required so that the MPCA will know that purpose of the construction activity is for an emergency situation.
- The owner and the operator of the emergency construction activity must comply with the requirements of the Construction Stormwater Permit that apply to specific stormwater management practices, and Best Management Practices (BMPs) used to prevent or mitigate polluted stormwater runoff from leaving the construction site.

For emergency construction that will disturb equal to or greater than five acres, the owner must immediately contact the Construction Stormwater Hotline at 651-757-2119 or 800-657-3804

## Notification

The MPCA will notify owners and operators of construction activities that disturb one to less than five acres of soil and meet the requirements stated above that they are covered under the Construction Stormwater Permit, even if the owner or operator has not submitted a permit application.

The construction activity must incorporate the erosion and sediment control requirements contained in the Construction Stormwater Permit even though a formal stormwater pollution prevention plan (SWPPP) has not been written. Though all requirements of the permit should be complied with, BMPs conducted on the site should at a minimum include these five steps to help you get your job done without damaging the environment:

### 1. Stabilize slopes

Without vegetation, whole hillsides are quickly washed away in a downpour. Cover your slopes with mats or mulch that will get plants growing right away.

### 2. Control your perimeter

Watch the flow of water on and off your site. Silt fences and other barriers make sure dirt doesn't escape. Embankments may keep extra water from entering your site.

### 3. Maintain silt fences

Silt fences only work so long, so replace them if they're torn or beat down. They'll also need to be replaced if silt has reached one-third the height of the fence.

### 4. Stop vehicle tracking

Install a section of coarse gravel at the exit to your site to keep mud off roads and residential streets.

### 5. Protect inlets

Prevent your stormwater ponds from filling with silt when you install storm-sewer inlet protection.

## Measuring area

The area of disturbance measured to determine if the project disturbance is one to less than five acres should include all areas to be graded or otherwise within what might be considered the construction limits including construction of access roads and staging areas. Even if your emergency repair project is less than an acre in size and therefore does not require Construction Stormwater Permit coverage, the Construction Stormwater Program always recommends you incorporate appropriate BMPs to minimize the impact of runoff from the construction site to the lakes, streams or wetlands down slope of the project.

## Submitting an application

A written project specific SWPPP must be developed and permit application submitted when the emergency effort becomes stabilized or for any follow-up project(s).

## More information

For more information contact the Construction Stormwater Hotline at 651-757-2119 or 800-657-3804.

Visit Minnesota Pollution Control Agency Stormwater Web site: [www.pca.state.mn.us/stormwater](http://www.pca.state.mn.us/stormwater)



# Concrete, paint, stucco and other washout guidance

## National Pollutant Discharge Elimination System/State Disposal System Construction Stormwater Permit requirements

Use this guidance for managing all liquid and solid wastes generated by washout operations (concrete, stucco, paint, form release oils, curing compounds, and other construction materials) related to construction activity on National Pollutant Discharge Elimination System/State Disposal System (NPDES/SDS) construction stormwater permitted sites. To protect water quality, the NPDES Construction Stormwater Permit requires best management practices (BMPs) for concrete and other washout wastes on construction sites.

### Background

The chutes of concrete mixers and hoppers of concrete pumps are typically rinsed out after delivery of concrete. Tools, hand mixers and wheel barrows are also washed to prevent hardening. Hardened concrete is relatively benign. However, liquid concrete wash water is a caustic material due to a high pH and it contains hazardous metals such as chromium. These materials can leach into the ground and contaminate groundwater. The high pH can inhibit plant growth and harm aquatic life if the runoff migrates to a lake or stream. Solids from liquid waste that are improperly disposed of can clog storm drain pipes and cause flooding. In order to comply with the prohibition of discharging any materials other than treated stormwater, there must be a means to prevent the discharge of washout water from the cleanup of stucco, paint, form release oils, curing compounds, and other construction materials.

The Minnesota Pollution Control Agency (MPCA) believes that groundwater and surface water can be protected from liquid concrete and other washout wastes through proper use of BMPs at NPDES/SDS construction stormwater permitted sites. Installing washout facilities not only prevents pollution but also is a matter of good housekeeping at a construction site.

### Washout at construction sites

Washout facilities are used to contain all concrete and liquid wash water generated by the construction activity. Liquid and solid washout wastes must be contained in a leak-proof container and cannot contact the ground. The washout containers should be covered to prevent exposure to rainfall and potential overflow.

Washout facilities should also be used for cleaning other cementitious (cement-like) construction materials from tools and equipment such as stucco, mortar, plaster and grout. Depositing the wash water into a container allows evaporation and hardening to occur for easier disposal and to prevent runoff of liquids.

While the Construction Stormwater Permit does not allow concrete chute rinse water to come into contact with the ground, the permit does allow the wasting, the end of the load of plastic structural concrete to come into contact with the ground. After drying,



Recover and recycle wash water back into the truck



the remaining solids may be used as a fill material, a component in recycled aggregate or any other commercially useful application. Up to 0.5 cubic yards of concrete solids may be managed/buried on-site. If concrete solids are buried on-site, they should be at least two feet below the surface and must not be buried within three feet of the groundwater table. Quantities larger than 0.5 cubic yards of concrete solids must either be managed with the rest of the site's solid wastes or obtain an approval from the MPCA's solid waste program for other beneficial use options.

There are circumstances where concrete washout may be allowed onto a prepared compacted road bed. This allowance is intended for slip form paving type machines that cannot be readily moved off the paving area to a washout station. The area where wash water will flow onto must be compacted and will be paved over the next day. There must be a barrier of some type to keep the wash water on the compacted road bed until it dries. This allowance is not intended for truck washouts.

A concrete washout sign must be installed at each temporary washout facility to inform the site personnel to use the designated facilities. The facility should be located close to the concrete pouring or mixing operation and be easily accessible by concrete mix trucks. It is also important to locate the facility so that spills or overflows will be directed away from storm drain inlets, curb and gutters, water conveyances or surface waters. The facility will need to be inspected regularly for leaks, damage, or potential overflow and receive regular maintenance.

## Washing of applicators and containers used for paint, concrete, or other materials

The permittee must comply with the prohibition of discharges other than stormwater (Part V.C) that includes the washout and cleanout of stucco, paint, concrete, form release oils, curing compounds, and other construction materials. The permittee must provide effective containment for all liquid and solid wastes generated by washout operations and provide an effective means to eliminate the discharge of these wastes to the site or receiving waters. To comply, the permittee should evaluate and incorporate methods in the Stormwater Pollution Prevention Plan to prevent these discharges such as:

1. Direct all wash water into a leak-proof container or leak-proof pit. The container or pit must be designed so that no overflows can occur due to inadequate sizing or precipitation;
2. Handle washout or cleanout wastes as follows:
  - Do not dump liquid wastes in storm sewers
  - Dispose of liquid wastes properly
  - Remove and dispose of hardened concrete waste consistent with the handling of other construction wastes
3. Locate any washout or cleanout activities as far away as possible from surface waters and stormwater inlets or conveyances, and, to the extent practicable, designate areas to be used for these activities and conduct such activities only in these areas.



Self-contained washout facility

## Best management practices

There are many BMP options for disposal of liquid and solid wastes from washout activities. Many ready mix trucks are now equipped with the ability to collect chute wash water and solids and return them to the concrete plant for recycling or re-use.

Services are also available for hire that deliver a prefabricated washout container to collect concrete chute rinse water as well as wash water from tools and equipment generated on-site. Some services provide the containers alone without providing maintenance and disposal of materials, while other companies offer complete service that includes delivery of containers and regular pickups of solid and



Concrete washout service

liquid waste materials. If these options are not available, the site owner and contractor can install a washout containment facility. A leak-proof container can be purchased or constructed onsite using an impermeable plastic or vinyl liner. The operators at the site will need to ensure no rips or tears develop in the liners or the liner will need to be replaced. Washout facilities should be designed to promote evaporation where feasible to harden the concrete or other washout wastes for disposal as a solid waste. Hardened concrete can also be crushed for reuse as a construction material. However, if stored liquids have not evaporated and the washout is nearing capacity, vacuum and dispose of the waste in an approved manner. The local municipal wastewater treatment plant may be contacted to determine if there are special disposal requirements for concrete or other washout waters at their facility.

If the waste is stored onsite, remove the liquids or cover the washout facility before predicted rainstorms to prevent overflows. Companies that offer prefabricated and watertight washout containers generally offer a vacuum service to remove the liquid material. In case of a spill, immediately contain the spread of the spill, recover spilled materials, clean up the area and properly dispose of materials. Hardened concrete solids can be removed whole or broken up first depending on the type of equipment available on-site. In accordance with Minn. R. 7035.2860, subp. 4, item 1; the hardened concrete can be used as a substitute for conventional aggregate. If the material is not utilized in accordance with the standing beneficial use determination referenced above, up to 0.5 cubic yards of concrete washout solids may be managed on-site. If concrete washout solids are buried on-site, they should be at least two feet below the surface and must not be buried in the groundwater table. Quantities larger than 0.5 cubic yards of concrete washout solids must either be managed with the rest of the sites solid wastes or obtain an approval from the MPCA's Solid Waste program for other beneficial use options.

## Road construction concrete cutting or grinding slurry

Other operations on-site such as saw cutting, coring, grinding and grooving or construction of exposed-aggregate concrete surfaces may generate a similar liquid wastewater. Process wastewater generated by these operations cannot be discharged into any of the nation's waterways. The MPCA recommends that liquid and solid wastes generated by these operations be handled in accordance with the fact sheet *Road Construction Concrete Slurry Guidance* found at <http://www.pca.state.mn.us/index.php/water/water-types-and-programs/stormwater/construction-stormwater/road-construction-concrete-slurry-guidance.html>.

## Local requirements

In addition to state requirements, please note that there may be city, county or watershed management organization requirements that may be more stringent than those found in the NPDES/SDS Construction Stormwater Permit.

## Definitions

*Concrete-chute rinse-off water:* Liquid wastes generated when a ready mix truck operator washes non-structural concrete materials off the chutes used to deliver concrete to a project.

*Concrete equipment and tools rinse-off water:* Liquid wastes generated when a concrete contractor or finisher washes non-structural concrete materials off tools or equipment used to place or finish concrete.

*Plastic concrete* is that freshly mixed structural concrete which is pliable and capable of being molded or shaped like a lump of modeling clay.

*Hardened structural concrete* is a strong, non-combustible, durable, abrasion-resistant and practically impermeable material.

## **Additional information**

United States Environmental Protection Agency Concrete Washout Guidelines:

<http://www.epa.gov/npdes/pubs/concretewashout.pdf>.

Minnesota Department of Transportation Concrete Guidance (except for reference to ground contact with low infiltration soils) <http://www.dot.state.mn.us/environment/erosion/construction.html>.

For more information, call the MPCA Stormwater Hotline at 651-757-2119 or 800-657-3804.



## Perimeter control

### National Pollutant Discharge Elimination System/State Disposal System Permit Guidance on the use of perimeter control



Silt fence used as perimeter control

Perimeter control is a method of sediment control best management practices (BMPs) that acts as a barrier to retain sediment on a construction site. Sediment control BMPs are intended to slow and hold flow, filter runoff, and promote the settling of sediment out of runoff, via ponding behind the sediment control BMP.

### What is required by the National Pollutant Discharge Elimination System/State Disposal System Construction Stormwater Permit?

The National Pollutant Discharge Elimination System/State Disposal System (NPDES/SDS) Construction Stormwater Permit (Permit) requires that certain sediment control BMPs are utilized to minimize sediment from leaving a construction site. Some sediment controls, such as ditch checks, may be needed to promote sheet flow and prevent rills and gullies from forming on steeper slopes or ditch bottoms. The Permit also requires additional sediment controls to be utilized at the base of soil piles to contain sediment. Sediment controls located at down gradient boundaries of the construction site are referred to as “perimeter controls”. The location and type of perimeter control BMPs, along with other sediment control BMPs required by the Permit, must be identified in the site’s Stormwater Pollution Prevention Plan (SWPPP).

The perimeter sediment control BMPs must be established on all down gradient perimeters and up-gradient of buffer zones before any land disturbing activities begin. These BMPs shall remain in place until final stabilization has been established. If the down gradient perimeter controls are overloaded, additional up gradient controls may be necessary to prevent further overloading. The selection of perimeter control BMPs is the permittee’s decision, but it must be effective at keeping sediment on the site. If it is determined through inspection that the selected method is not effective, then the BMP must be upgraded to a method that is effective at keeping sediment on the site.

The timing of the perimeter control installation may be adjusted to accommodate short term activities such as clearing and grubbing, and passage of vehicles. This means these BMPs may be taken down as necessary to allow vehicle on and off areas of the site or to allow work such as utilities to be installed through the perimeter BMP. These short term activities must be completed as quickly as possible and the perimeter control BMPs must be reinstalled immediately after the activity is finished. All perimeter control BMPs, however, must be in place before the next precipitation event, even if the activity is not complete. For full details of the Permit requirements, a copy of the NPDES/SDS Permit can be found at [www.pca.state.mn.us/water/stormwater/stormwater-c.html](http://www.pca.state.mn.us/water/stormwater/stormwater-c.html).

## Types of perimeter sediment control

Silt fence is a commonly known method of perimeter control. However, other types of perimeter controls exist that can be equally or even more effective depending on the construction site circumstances. The following sediment control BMPs are commonly used as perimeter control on construction sites of all sizes:

- Ditch checks
- Rock logs
- Compost berms, logs, and rolls
- Biorolls
- Sand bags
- Vegetated or stabilized soil berms
- Geotextile wrapped jersey barriers
- Existing vegetation
- Silt fence
  - Super duty
  - Heavy duty
  - Preassembled

## Planning perimeter sediment control

Perimeter controls should be planned as a system, taking the entire site into consideration and installed prior to any land disturbing activity, and only need to be installed in locations down gradient of the construction. The design of a site's perimeter control system should anticipate ponding that will occur up gradient of the controls and provide sufficient storage and deposition areas and stabilized outlets to prevent flows from over topping the controls. The SWPPP must account for the following factors in designing the temporary erosion prevention and sediment control BMPs including perimeter controls:

1. The expected amount, frequency, intensity, and duration of precipitation.
2. The nature of stormwater runoff and run-on at the site, including factors such as expected flow from impervious surfaces, slopes, and site drainage features.
3. If any stormwater flow will be channelized at the site, the Permitte(s) must design BMPs to control both peak flow rates and total stormwater volume to minimize erosion at outlets and to minimize downstream channel and stream bank erosion.
4. The range of soil particle sizes expected to be present on the site.

Flows should be strategically directed to specified deposition areas through appropriate positioning of the perimeter controls and site grading. Sometimes additional perimeter controls need to be added or moved to different locations on a project as conditions change. For example, perimeter control is installed above street curbs once the curb and gutter system is installed to keep sediment out of the water conveyance. Some perimeter controls can be relocated as needed, such as biorolls, rock logs, sand bags, and triangular silt dikes. Keeping a vegetated buffer between disturbed areas on a construction site and the down gradient perimeter control BMP can help the BMP perform better and need less maintenance.

Perimeter control BMPs serve no function along ridges or drainage divides where there is little movement of water. Perimeter controls should be installed on the contour of slopes, and the ends of the BMP should bend up slope forming a crescent shape or a "J- hook" rather than a straight line. This will prevent runoff from flowing around the ends of the controls.

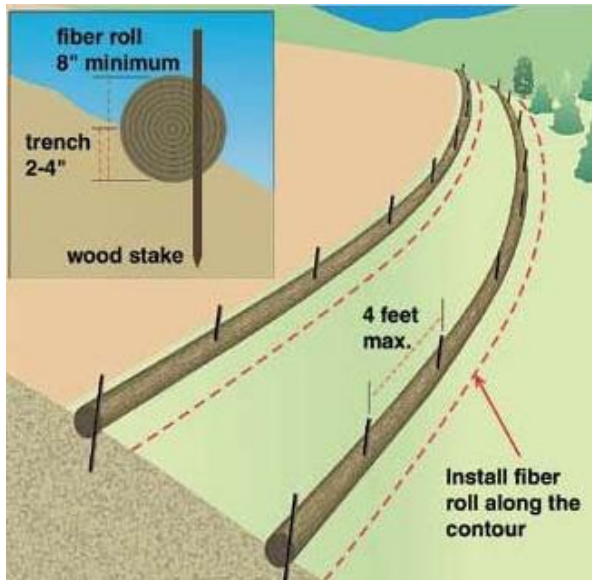

Install biorolls or other sediment controls along the contour of the slope.



"J-hooked" silt fencing

## Maintenance considerations

The NPDES/SDS Permit requires that all BMPs are inspected once every seven days or within 24 hours of a rainfall event greater than 0.5 inches in 24 hours. All perimeter control devices must be repaired, replaced, or supplemented when they become nonfunctional or the sediment reaches one half (1/2) of the height of the device. These repairs must be made by the end of the next business day after discover, or thereafter as soon as field conditions allow access.

After the contributing drainage area has been stabilized, all sediment controls and the associated sediment build up must be removed and disposed of properly. Care should be taken to dispose of sediment in a location that is not susceptible to erosion.

## Cold weather considerations

It is important to consider winter conditions when planning a perimeter control system. All construction sites must remain in compliance with the NPDES/SDS Permit throughout the winter even if no construction is occurring. It is imperative that properly functioning sediment controls are in place during minor thaws and for the large spring snowmelt to prevent transport of sediment to area surface waters. For this reason, the BMPs must be installed and functional prior to winter freeze up. The BMPs must be inspected and maintained immediately following intermittent snow melt or rainfall that occurs in winter months. If construction resumes during the winter, then the weekly inspection schedule must also resume.

The best way to ensure proper functioning of perimeter controls throughout the winter is to have all sediment controls installed prior to the first freeze. Stakes needed for some sediment control BMPs will be difficult, if not impossible to install into frozen ground. The site's SWPPP should clearly outline the strategy to prepare the site for the winter months.

If construction is going to continue during the winter and new areas will be disturbed that requires new sediment controls; materials such as compost berms, logs and rolls, fiber rolls, rock bags and rock filters can be installed over the snow cover.

These installations will need extra care and frequent inspections to assure continued effectiveness.



Regular maintenance is needed to ensure that a site's perimeter control is functioning properly.

## Use of down gradient perimeter sediment control for work in or near open water

It is critical to ensure down gradient perimeter controls are utilized during work on stream banks and lake shores to keep sediment from washing into open water. Sediment discharges resulting from this type of construction can result in enforceable water quality violations.

Sites that include work in public waters permits from the Department of Natural Resources (DNR) that also have coverage under the Minnesota Pollution Control Agency's (MPCA) general construction stormwater permit are required to comply with the conditions in both permits, including the use of down gradient perimeter controls to minimize sediment discharges.

More specialized types of sediment control BMPs may be needed to protect surface waters during construction that extends below the water surface. Whenever possible, work below the Ordinary High Water table should be done in a manner that keeps water out of the work area, or separated from flowing water. For example, coffer dams made of sheet piling or other materials to isolate the work from the water or water diversions to divert water around the work area may be the best choices during bridge construction or any work that encroaches into open water.



Biorolls, rock logs, sand bags, triangular silt dikes, geotextile wrapped jersey barriers or stabilized soil berms that can easily be relocated may be best during stream bank restoration work. The perimeter control method may need to change as work changes at the site. Therefore, multiple perimeter control methods may be employed at one site at different times or at the same time.

If the work is conducted on an MPCA designated special water, such as a trout stream or scenic and recreational river segment,

redundant BMPs must be employed when an existing 100 foot buffer is encroached. In this case, more than one method of perimeter control is employed or a super duty perimeter control method may be required to adequately protect the surface water.

## Protection of wildlife

Perimeter controls have been known to trap amphibians, reptiles, and small mammals within a construction area. Of concern is the inadvertent harm to rare species. Inspectors of perimeter controls should move rare species out of harm's way if they appear trapped or are in imminent danger. If not in danger, they should be left alone. In areas of known rare species populations, silt fence may also be helpful in keeping these animals out the construction area. In all cases it is critical that silt fencing be removed after the area has been re-vegetated. More information on Minnesota's rare species can be found on the DNR website: <http://www.dnr.state.mn.us/ets/index.html>.

## Floating curtain is not perimeter control

Frequently, floating silt curtains are employed during work in water. However, it is important to note that floating curtains will not satisfy MPCA's NPDES/SDS Permit requirement for down gradient



perimeter control. Even if a floating curtain is utilized, down gradient perimeter control must still be installed between the work and the surface water to prevent sediment from entering the surface water. A nuisance condition (as described in Minn. R. 7050.0210 sub. 2) caused by allowing sediment runoff into the water body is a water quality violation.

**Relying on floating curtain as down gradient perimeter control will result in permit violations for failure to install sediment control and in most cases will result in water quality violations.**

Floating silt curtain is not designed to prevent sediment from entering surface water. It is designed to help contain suspended sediment within the water column until it has settled to the bottom of the water body. Therefore, floating curtain's only use may be for work that cannot be done outside the water or as a secondary containment to minimize the impact of a water quality violation and keep the damage to the water body near the shore and the sediment recoverable.



**Use floating silt curtain for work in the water as secondary containment to contain sediment close to the work area.**

## **Proper placement of perimeter sediment controls near water**

Perimeter controls need to be installed before upgradient work begins. The perimeter control should be placed at the water's edge during work on the bank or shoreline. If possible, vegetation should be left between disturbed areas and the sediment control BMP. As work is completed on the bank and the bank is fully stabilized, the perimeter controls can be moved upward away from the water's edge above the vegetated or rip rapped areas.



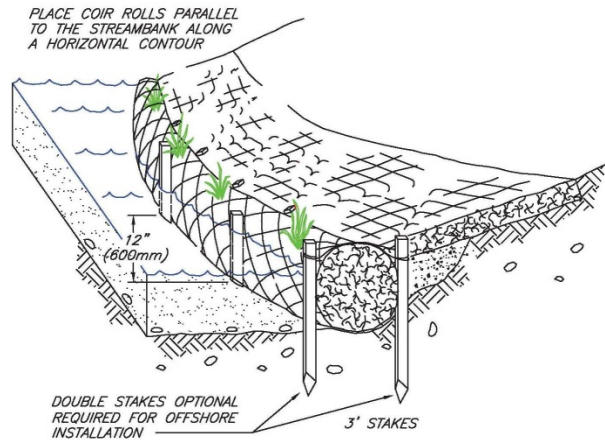

Fiber roll installation at shoreline.



Move perimeter controls up the bank as the bank is stabilized.

## Additional resources

Additional information on the use of perimeter controls; including use of floating silt curtain, water diversions, coffer dams and other perimeter control BMPs for work in or near waters as well as all other applications can be found in the *MPCA Protecting Water Quality in Urban Areas – Manual*  
<http://www.pca.state.mn.us/index.php/view-document.html?gid=7157>.

Minnesota DNR species protection information

[http://files.dnr.state.mn.us/waters/watermgmt\\_section/pwpermits/gp\\_2004\\_0001\\_chapter1.pdf](http://files.dnr.state.mn.us/waters/watermgmt_section/pwpermits/gp_2004_0001_chapter1.pdf).

*MPCA Stormwater Construction Inspection Guide*

<http://www.pca.state.mn.us/publications/wq-strm2-10.pdf>.

United States Environmental Protection Agency NPDES Menu of BMPs – Construction Site Sediment Control – *Silt Fences*

<http://cfpub.epa.gov/npdes/stormwater/menuofbmps/index.cfm?action=browse&Rbutton=detail&bmp=56&minmeasure=4>.



# Site stabilization

## NPDES/SDS Construction Stormwater permit requirements

Improperly treated and untreated runoff from exposed soils of a construction site can cause soil erosion and sedimentation problems resulting in the pollution of lakes, rivers, and other water bodies. This factsheet provides guidance on stabilizing a construction site to protect the quality of our water resources.

### The erosion process

Erosion is the natural process in which soil and rock material is weathered and carried away by wind, rain, snow or ice. Factors such as rainfall, climate, location, and soil type that influence erosion.



Subsoil erosion at a construction site.

Construction activities increase the ability of soil to erode once the vegetation and the top soil are removed. When the subsoil is exposed to the elements, the soil can erode very quickly. Wind and rain carry the soil off the construction site and sediment is deposited into our surface waters. This causes adverse effects on the quality of our water and to the health of aquatic life. Sediment runoff often carries additional pollutants such as nutrients, petroleum products, fecal matter and other contaminants from construction sites that further impact our lakes and rivers. It has been shown that it is far less costly to prevent

erosion than to attempt to mitigate the effects of erosion after it has occurred. Through proper use of best management practices (BMPs), including temporary and permanent covers to stabilize soils along with other practices to prevent erosion; such as the use of construction phasing, horizontal slope grading, vegetative buffers and water diversions, these effects can be substantially minimized.

### What is required by the NPDES/SDS Construction Stormwater permit?

The National Pollutant Discharge Elimination System (NPDES)/State Disposal System (SDS) Construction Stormwater permit identifies certain site requirements in regard to erosion prevention that, if utilized properly along with all other BMPs required by the permit, can effectively control erosion and sediment problems on a construction site.

Site stabilization is the process of implementing specific BMPs for the purpose of preventing soil from eroding. BMPs utilized for this purpose involve establishing a cover of some type over the exposed soils such as mulch, staked sod, riprap, erosion control blankets, or other material that prevents soil from eroding. Covering the soil with seed only, is not considered a stabilization practice. Mulch needs to be applied with the seed to stabilize the soil until the vegetation is established.

Sediment control BMPs, such as silt fence, rock checks, bio rolls, drainage swales, sediment traps or perimeter controls are utilized along with the soil stabilization BMPs. Perimeter controls are used to trap sediment prior to leaving the site, but alone are not considered soil stabilization practices. See <http://www.pca.state.mn.us/index.php/view-document.html?gid=7420> for more on perimeter sediment controls.

At a minimum, the permit requires that the following practices are utilized to prevent soil from eroding at construction sites:

- Phase the construction when feasible to limit the amount of soil exposed at one time.
- Delineate areas not to be disturbed with flags stakes, silt fence or with signs. These areas also need to be noted on the plan sets.
- Avoid disturbance of steep slopes or utilize stabilization practices designed for steep slopes, such as terracing or slope draining to minimize erosion.
- Route stormwater around exposed soil areas through use of conveyance channels when feasible.
- Direct stormwater discharges from the site to vegetated areas in order to increase sediment removal and infiltrate stormwater on the site when feasible.
- Utilize vegetative buffers, horizontal slope grading, and maintenance to protect surface waters.
- Use check dams, sediment traps, riprap, or grouted rip rap at outlets and along conveyance channels to control velocity and minimize erosion along the channel and outlets.
- Install energy dissipation such as concrete aprons, splash pads, rip rap, and gabions at pipe outlets within 24 hours of connecting to a *surface water*.
- Initiate soil stabilization *immediately* on portions of the site, including soil stockpiles, where construction activity has temporarily or permanently ceased and will not resume for 14 days.
- Stabilize exposed soils within 24 hours on portions of the site that drain to a public water where the Department of Natural Resources has declared “work in water restrictions” during fish spawning time frames.
- Stabilize the last 200 feet of the normal wetted perimeter of any temporary or permanent drainage ditch or swale that drains water from the site within 24 hours of connecting to a property edge or a discharge point to a *surface water*. Use erosion blankets, rip rap or other cover designed for concentrated flow areas.

Note that the permit definition for *surface water* in the permit is not just lakes or streams, but also any natural or artificial water feature including drainage systems such as ditches, swales, or inlets. Therefore, ditches or swales that connect to another drainage system must follow these requirements.

- Stabilize the remaining portions of the ditch or swale within 14 days where construction of that portion of the ditch has temporarily or permanently ceased.

## Special considerations

If the construction site is within one mile of a special or impaired water (defined in Part B.1. through B.9 and B.10 in Appendix A of the permit), as determined by the aerial radial distance from the site and not the flow distance; the following additional erosion prevention requirements are required in regard to preventing erosion:

- Initiate stabilization of all exposed areas immediately at the site and ensure the stabilization is complete no later than seven days after the construction activity in that area has temporarily or permanently ceased.
- Maintain an undisturbed buffer zone of not less than 100 feet from special waters at all times. If construction is such that the buffer must be encroached, use redundant BMPs sufficient to protect the special water. For more information on buffers see <http://www.pca.state.mn.us/index.php/view-document.html?gid=7400>.

For full details of the permit requirements, a copy of the NPDES/SDS Construction Stormwater permit is available online: [www.pca.state.mn.us/water/stormwater/stormwater-c.html](http://www.pca.state.mn.us/water/stormwater/stormwater-c.html).

## Managing soil stabilization timelines

Temporary stabilization BMPs are meant to cover bare soil to reduce the potential of soil erosion during the construction. It is important to utilize temporary stabilization techniques throughout the duration of the project as well as at the end of the project to achieve final stabilization.

The permit requires that the Permittees take action to initiate soil stabilization immediately when it is known that *construction activities* will not resume for 14 days for most sites, seven days for sites that drain to special or impaired waters and within 24 hours for sites where DNR “work in water restrictions” apply during fish spawning timeframes. Plan to utilize temporary cover on portions of the site that will sit dormant for these periods of time whether or not final grading has been completed.

Note that *construction activity* is defined in the permit as land disturbance that changes topography or existing soil cover and does not include the construction activity on the site to build vertical infrastructure such as buildings or bridges or application of pavement to roads and parking lots. Vehicle traffic on the site is also not considered *construction activity* for purposes of the permit. Therefore, even if building construction or other non-soil disturbing activity is continuing at the site, the surrounding soils that are not actively worked must still be stabilized within the permit timelines.

*Initiating immediately* means by the end of the day following the day land-disturbing activities have temporarily or permanently ceased. Activities that can be taken to initiate stabilization include:

- Starting to prep the soil of the area to be stabilized for vegetative or non-vegetative stabilization.
- Starting to apply mulch or other non-vegetative product to at least a portion of the area to be stabilized.
- Starting to seed or plant at least a portion of the area to be stabilized.
- Or, finalizing arrangements to have the soil stabilization product installed within the deadline for completing the soil stabilization.

Due to constantly changing circumstances at construction sites and limited life span of temporary BMPs, expect that stabilization BMPs may need to be replaced several times over the length of the project. Having additional materials available at the site can help manage the soil stabilization requirements and timelines for completing maintenance.

## What else can I do to keep my site stabilized and limit soil erosion?

- Minimize the total area of a site exposed at once by leaving as much vegetation on site as possible, for as long as possible, to reduce the overall amount of disturbed area.
- Minimize the length of time that soil is exposed by stabilizing areas as work progresses.
- Prevent runoff from flowing across disturbed areas by diverting the flow to vegetated areas.
- Break up slope lengths and steepness to promote sheet flow with check dams.
- Cover soil stock piles.
- Promptly stabilize soils after construction activity has stopped on any portion of the site.
- Regularly inspect the site and promptly repair, replace or enhance stabilization BMPs that are not performing adequately.
- Ensure mulch, hydromulch, erosion blankets, and other stabilization BMPs are applied according to the manufacturer's specifications.
- Keep track of weather reports and take action to protect the site prior to heavy rain, snow or frozen conditions.
- Keep extra stabilization BMPs onsite for quick response to failing BMPs and predicted storm events.

Any and all tools that you plan to implement on the site should be included in the site's SWPPP. When writing the SWPPP, include a description of the practices and integrate them into the time line of all construction activities. In addition, label the locations of the practices on site plans and include detailed

specifications for each practice. Including these elements into the SWPPP before construction activity begins will aid in proper planning for the site and ensure that the sediment and erosion control techniques are implemented effectively and efficiently.

The following are examples of additional erosion control techniques to be incorporated into the project plans:

**Construction site phasing** is the development of a construction work schedule that strategically coordinates the timing of land disturbing activities to minimize soil exposure and plans for the timely installation of all erosion and sediment control practices. The goal of construction site phasing is to disturb a smaller portion of an overall site, substantially finish grading and other construction activities and achieve temporary or permanent stabilization in the area before disturbing the next portion of the overall site. Soil exposure time is decreased, soil and erosion control practices are more manageable, and permit violations can be easily avoided.



Leave as much vegetation on a site as possible to reduce the overall disturbed area.

**Surface roughening** involves roughening the surface of the soil on slopes in a horizontally grooved pattern. This is often accomplished by tracking, stair-step grading or ripping and grooving. The roughened surface reduces erosion by decreasing runoff velocity, increasing infiltration, and aiding in the establishment of temporary or permanent vegetation and cover.

**Low impact development (LID)** is a stormwater management approach with the goal of keeping stormwater where it falls and reducing or even eliminating stormwater runoff from a site. LID integrates stormwater management practices into the planned or existing infrastructure in a way that mimics the predevelopment hydrology of the site. The techniques provide the filtering of sediment, nutrients, heavy metals and other pollutants from the runoff and result in decreased erosion, increased infiltration, and improved water quality. LID techniques such as protecting natural and existing vegetation, avoiding steep slopes, protecting infiltration areas and minimizing soil compaction can be utilized to prevent unnecessary erosion and sediment pollution problems. For additional information on LID visit: [www.pca.state.mn.us/publications/p-gen3-06.pdf](http://www.pca.state.mn.us/publications/p-gen3-06.pdf).

**Lot benching** is often utilized in subdivision developments. Lots are strategically graded to direct the runoff from each lot to a stable outlet rather than to an adjacent lot. Lot benching can result in reduced slope lengths and steepness, decreasing the potential for soil erosion. Lot benching establishes drainage patterns early in the construction process for each lot therefore avoiding potential drainage problems in the future when home construction begins.

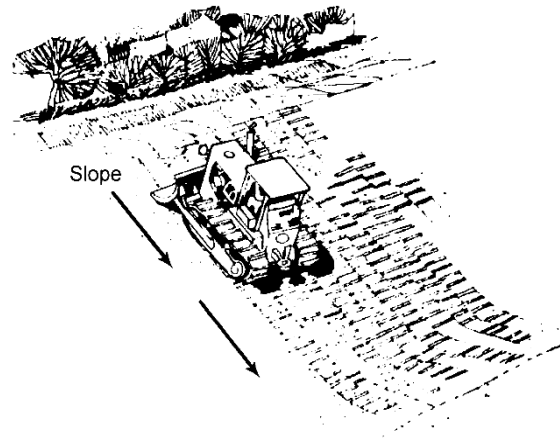

Slope tracking roughens the surface of a slope and decreases the velocity of runoff.

## Application of temporary and permanent covers

Permanent cover should be used to accomplish final stabilization at the end of a project or on areas that will sit dormant for an extended period of time. The following are commonly used temporary and

permanent cover practices that can be combined and used in conjunction with each other depending on the specifics of a site:

- Seed mixes are available to establish temporary and permanent vegetative cover on exposed soil. The Minnesota Department of Transportation (Mn/DOT) has researched various seed mixes and has identified mixes for specific site characteristics and uses. Reference the Mn/DOT Standard Specifications for Construction and the Mn/DOT Seeding Manual for specifics on seed mixes for your site. Links to both Mn/DOT documents are in Resources at the end of this fact sheet.
- Providing proper moisture, nutrients and fertilization are important to establishing permanent vegetation. Fertilization is site specific and should be chosen after a soil test is completed. For more information on soil testing, see the Soil Testing Laboratory at the University of Minnesota at <http://soiltest.cfans.umn.edu/>.
- Mulch is applied to form a temporary and protective cover on exposed soils. Mulch can help retain moisture in the soil to promote vegetative growth, reduce evaporation, insulate the soil, and reduce erosion. Common mulch materials are straw or wood chips. It is important to apply at proper rates to ensure adequate coverage. Straw mulch is typically applied at two tons/acre to achieve at least 90 percent soil coverage.
- Hydraulic soil stabilizers are hydraulically applied soil tackifiers or mulch material. The soil tackifiers help “glue” soil particles together to prevent erosion. There are many types, each with its own purpose. They may be applied with or without seed. Hydraulic soil stabilizers are often used as a temporary application on steep slopes or areas with limited access or to aid in seed germination (hydroseeding). They are not appropriate for use in concentrated flow locations, such as in road ditches. It is also important to apply the product at correct rates to be effective in preventing erosion. Hydromulches should provide 100 percent soil coverage.
- Erosion control blankets and turf reinforcement mats are single or multiple layer sheets made of natural and/or synthetic materials that provide structural stability to bare surfaces and slopes. Blankets and mats are often used in conjunction with seed mixes to promote vegetation establishment. A wide variety of blankets and mats exist for use under varying circumstances. In addition, compost can be used for erosion control and site stabilization.
- Compost can be used as an erosion control measure and to establish vegetation as well. The compost should be finished and without odor. It can be applied quickly and uniformly with hydraulic application.
- Sod is commonly used for permanent stabilization and for immediate visual aesthetics on a bare site. Sod can provide immediate stabilization around drop inlets and in swales, ditches, and channels.



Hydrodraulic soil stabilizers promote the rapid growth of vegetation and prevent erosion.



Erosion control blanket stabilizes pond slopes.

## What best management practices should I choose for my site?

Choosing the right BMP can be challenging with so many options. Often price is a deciding factor, however the least expensive erosion protection techniques may not be the longest lasting, the most cost effective or the most appropriate for your site. Insufficient protection may leave you with the cost

of repairing an eroded slope, replacing the BMP over and over again and/or fines for permit violations. Carefully consider the specifics of your project including the climate, existing soils, and slope lengths and steepness before choosing a cover or practices. In the long run, choosing the right products and practices for your site will save you time and money.

## Cold climate considerations

The best approach to winter months is to plan ahead at the start of a project and develop a sequenced construction schedule to ensure that all exposed areas have cover before the first freeze. Preparation of vegetative cover should begin in the fall. Seeds must be started early enough for them to germinate, establish roots and provide cover before the winter begins. Reference the Mn/DOT Standard Specification for Construction for specifics on the last seeding date in your area. If construction is continuing through winter and new areas are disturbed, cover material can be applied over snow.

It is important to note that all construction sites must remain in compliance with the NPDES permit throughout the winter even if no construction is occurring. For this reason, ensure the site is compliant with permit requirements prior to ceasing construction due to frozen conditions. The site must be inspected and maintained during the winter whenever snow melt or rain fall occurs even if construction is not active. If construction continues or resumes during the winter, inspection and maintenance must continue on a regular basis during the winter months.

## Maintenance and inspection

The NPDES permit requires that the entire construction site be inspected once every seven days or within 24 hours of a rainfall event greater than 0.5 inches in 24 hours. All non-functioning BMPs must be replaced, repaired or supplemented with functional practices within 24 hours of discovery or as soon as field conditions allow access. The permittee is responsible for the operation and maintenance of all erosion prevention and sediment control Best Management Practices (BMPs) for the duration of the project. All inspections and maintenance and any changes throughout the construction process should be recorded and kept onsite with the SWPPP.



Image Courtesy of Emmons & Olivier

Stabilization BMPs should be inspected and maintained through the winter season.

## What is final site stabilization?

As defined in the NPDES/SDS Construction Stormwater permit, final stabilization is achieved when all soil disturbing activity is completed and the exposed soils have been stabilized with a vegetative cover with a uniform density of at least 70 percent over the entire site or by equivalent means to prevent soil failure. Simply seeding and mulching is not considered acceptable cover for final stabilization. Final stabilization must consist of an established permanent cover, such as a perennial vegetative cover, concrete, rip rap, gravel, roof tops, asphalt, etc.



Final stabilization is achieved when all soil disturbing activity is completed and the exposed soils have been stabilized with a vegetative cover with a density of 70 percent over the entire site.

The permanent stormwater treatment system must be in place and functioning. Drainage ditches and other conveyance systems must have all collected sediment cleaned out and be stabilized with permanent cover. Temporary erosion and sediment control BMPs must be removed.

For residential construction sites, individual lots are considered to have final stabilization if the structure or building is completed, temporary erosion protection and down gradient perimeter control is in place, and the residential lot has been sold to the homeowner. The permittee is required to give the new homeowner a copy of the MPCA's "Homeowner Fact Sheet."

<http://www.pca.state.mn.us/publications/wq-strm2-07.pdf>.

For construction on agricultural land, final stabilization can be achieved by returning the land to its preconstruction agricultural use, such as crop production or range land. This does not apply to construction projects on agricultural land that will not be returned exclusively to agricultural use after all the construction is complete. For more information see the factsheet

<http://www.pca.state.mn.us/index.php/water/water-types-and-programs/stormwater/construction-stormwater/crop-production-on-npdes/sds-construction-stormwater-permitted-sites.html>

## Resources

Mn/DOT approved products list

<http://www.mrr.dot.state.mn.us/materials/ApprovedProducts/appchart.asp#ipl>

Mn/DOT seeding manual

[http://www.dot.state.mn.us/environment/pdf\\_files/seedingmanual.pdf](http://www.dot.state.mn.us/environment/pdf_files/seedingmanual.pdf)

Mn/DOT standard specifications for construction

<http://www.dot.state.mn.us/pre-letting/spec/index.html>

MPCA protecting water quality in urban areas – manual – chapter 6: erosion prevention and sediment control <http://www.pca.state.mn.us/water/pubs/sw-bmpmanual.html>

MPCA stormwater construction inspection guide

<http://www.pca.state.mn.us/publications/wq-strm2-10.pdf>.

U.S. Environmental Protection Agency NPDES menu of BMPs

<http://cfpub.epa.gov/npdes/stormwater/menuofbmps>





Minnesota  
Pollution  
Control  
Agency

# Stormwater Inlet Protection

## NPDES/SDS Construction Stormwater Permit Requirements

wq-strm2-28 • October 2009

The goal of stormwater inlet protection is to trap sediment from a construction site before it enters a storm sewer. This will keep sediment from being transported to lakes or streams and can also prevent clogging of the storm sewer caused by heavy sediment loads. A stormwater inlet refers to manholes, catch basins, curb inlets and other drop-type structures constructed to direct stormwater into storm sewers or other underground drainage systems. Inlet protection best management practices (BMPs) are fairly inexpensive, easy to construct, and if maintained properly can successfully reduce sediments from entering our waterways.

### What is required by the NPDES/SDS construction stormwater permit?

The NPDES/SDS construction stormwater permit requires that sediment control practices be utilized to minimize sediment from entering surface waters, curb and gutter systems and storm sewer inlets. The permit states that all storm drain inlets must be protected by appropriate BMPs throughout construction and until all sources with potential for discharging to the inlet have been stabilized.

The permit also requires that the inlet protection BMPs be inspected at least once every seven days and within 24 hours after a rainfall event greater than 0.5 inches in 24 hours. All nonfunctioning inlet protection BMPs must be replaced or repaired within 24 hours of discovery. For full details of the permit requirements, a copy of the NPDES/SDS construction

stormwater permit is available online: [www.pca.state.mn.us/water/stormwater/stormwater-c.html](http://www.pca.state.mn.us/water/stormwater/stormwater-c.html).



Stormwater inlet protection BMPs can be inserted into a catch basin to trap sediment from a construction site before it enters a storm sewer.

### Planning considerations

Inlet protection BMPs should be installed prior to any soil disturbance on a construction site where storm sewer systems are in place or BMPs should be installed as storm sewer systems are constructed and inlets begin collecting stormwater. The basic approach to inlet protection BMPs is to install a barrier around the inlet that ponds or filters the flow of stormwater resulting in the settling or filtration of sediment. It is important to note that ponding will occur behind the inlet protection BMPs and that regular maintenance is needed to remove sediment and prevent a safety hazard. Many different types of inlet protection BMPs exist and can be utilized depending on the field conditions and type of inlet.

Commonly used inlet protection BMPs include:

- Rock logs
- Compost logs
- Sediment control inlet hats
- Silt fence rings and rock filter combinations
- Pop-up head risers
- Filter bag inserts
- Sand or gravel bags

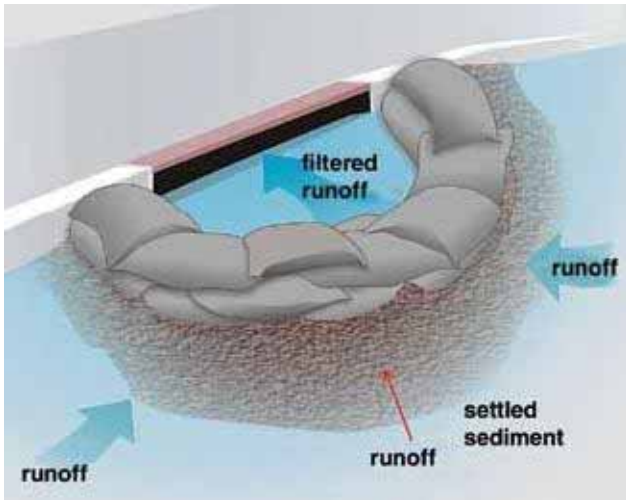

Inlet protection BMPs such as sand or gravel bags are used to filter stormwater runoff before entering a catch basin. Commercial products are available that fit in front of or inside the catch basin to filter stormwater.

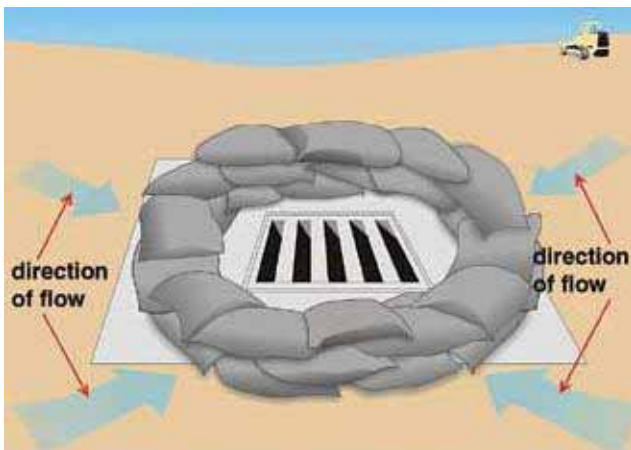

Inlet protection BMPs such as sand or gravel bags can be used to protect a drop inlet by filtering stormwater runoff and preventing sediment from entering the inlet.

Additional commercial products are available. See Resources at the end of this factsheet for a link to the Minnesota Department of Transportation's list of approved products.

## Maintenance considerations

The effectiveness of inlet protection BMPs is greatly diminished if not maintained properly. After each rainfall, inlet protection should be inspected. Sediment collected around the inlet protection BMP should be regularly removed. Care should be taken to dispose of sediment in a location that is not susceptible to additional erosion.

If excess sediment clogs or blocks the inlet protection BMP, flooding may occur and cause a safety hazard or property damage. If significant ponding does occur around the inlet, inspect for any clogging that may be preventing proper drawdown. As soon as the contributing drainage area is stabilized, the inlet protection BMP should be removed.

## Cold climate considerations

It is important to consider winter conditions when planning construction and designing inlet protection BMPs. Construction sites must comply with the NPDES/SDS permit throughout winter even if the site is idle and regular inspection of the inlet protection must continue throughout the winter months.

The most common problem with inlet protection BMPs in the winter is clogging due to ice build-up. Snow should be removed around the inlets when possible to prevent the snow from melting and freezing creating ice build-up. If ice build-up does occur, it is necessary to manually break-up the ice for removal or use steam to instigate melting. Under no circumstance should salt be used to remove the ice. Using salt adds unnecessary salt loads to the drainage system.



Image Courtesy of Emmons & Olivier Resources, Inc.

Snow should be removed from around catch basins with installed inlet protection BMPs to prevent ice build-up and clogging.

Drainage system inlet inserts and filters can become a potential source of freeze-up, especially if water does not drain immediately through the BMP. All BMPs used at inlets should have overflow assurance so that flow will by-pass a frozen fabric or natural material filter. Inspection and maintenance will often result in easy ice break-up when problems are quickly discovered.

Prior to the spring, site managers should inspect each of the inlets and undertake actions as necessary to assure unimpeded flow through the inlet protection BMPs.



Image Courtesy of Emmons & Olivier Resources, Inc.

Maintenance should continue through the winter months to ensure that inlet protection BMP is functioning properly.

## Resources

*Metropolitan Council Urban Small Sites Best Management Practice Manual – Soil Erosion Control – Inlet Protection*

[http://www.metrocouncil.org/environment/Watershed/bmp/CH3\\_RPPSedInletProtect.pdf](http://www.metrocouncil.org/environment/Watershed/bmp/CH3_RPPSedInletProtect.pdf)

*Minnesota Department of Transportation (Mn/DOT) Approved Products*

List <http://www.mrr.dot.state.mn.us/materials/ApprovedProducts/appchart.asp#ipl>

*MPCA Protecting Water Quality in Urban Areas – Manual* <http://www.pca.state.mn.us/water/pubs/sw-bmpmanual.html>

*MPCA Stormwater Construction Inspection Guide* <http://www.pca.state.mn.us/publications/wq-strm2-10.pdf>

*USEPA National Pollutant Discharge Elimination System (NPDES) Menu of BMPs - Construction Site Sediment Control – Storm Drain Inlet Protection*

<http://cfpub.epa.gov/npdes/stormwater/menuofbmps/index.cfm?action=browse&Rbutton=detail&bmp=60&minmeasure=4>

*Small Business Environmental Assistance Program Compliance Calendar for Construction Stormwater*

<http://www.pca.state.mn.us/publications/wq-strm2-08.pdf>



### Sediment control practices - Vehicle tracking BMPs

A vehicle tracking BMP is a rock (stone, gravel) pad, shaker rack, wheel washer, or other BMP designed to remove soil and mud from vehicles leaving the work zone and entering offsite areas, such as public roadways and public or private parking lots.



Properly constructed BMP for vehicle tracking.



Example of a site with poor vehicle tracking practices.

#### Contents

- 1 Purpose and function
- 2 Applicability
  - 2.1 Site applicability
  - 2.2 Permit applicability
- 3 Effectiveness
- 4 Planning considerations
- 5 Design and construction
  - 5.1 Rock/stone pad (vehicle tracking pad)
  - 5.2 Shaker rack
  - 5.3 Wheel washer/wash rack
- 6 Standards and specifications
- 7 Inspection
- 8 Maintenance
- 9 Costs
- 10 Reference materials
- 11 Related pages

#### Purpose and function

Vehicles leaving construction sites track sediment onto adjoining roadways. This sediment can create safety hazards and contribute significantly to sediment pollution in waterways. The purpose of a vehicle tracking BMP is to prevent soil and mud on work vehicles from being carried offsite and deposited on public roads, parking lots, and other areas. Temporary site entrances/exits are used during the construction period, prior to the time when roadways, parking lots, and other areas are either paved or stabilized. Vehicle tracking BMPs limit the amount of sediment and other pollutants leaving the construction site and reduces discharge of sediment and pollutants to surface waters. Pollutant removal is primarily accomplished through the removal of soil and mud from construction equipment, including nutrients and heavy metals that are associated with sediment (see section on Effectiveness).

**Caution:** To the extent feasible, erosion prevention practices such as stabilization are preferred to sediment control practices.

## Applicability

Vehicle tracking BMPs are installed at all construction sites where there is a risk of mud and soil clinging to vehicles leaving the site.

### Site applicability

Vehicle tracking BMPs are appropriate during the construction period for all sites with vehicles passing through disturbed areas prior to entering public roadways or other offsite areas.

### Permit applicability

Section IV.C.6 of the 2013 MPCA Construction Stormwater General Permit states that “(w)here vehicle traffic leaves any part of the site (or onto paved roads within the site): (a)The Permittee(s) must install a vehicle tracking BMP to minimize the track out of sediment from the construction site. Examples of vehicle tracking BMPs include (but are not limited to) rock pads, mud mats, slash mulch, concrete or steel wash racks, or equivalent systems” and “(b) The Permittee(s) must use street sweeping if such vehicle tracking BMPs are not adequate to prevent sediment from being tracked onto the street”.

Section IV.E.5.d of the 2013 MPCA Construction Stormwater General Permit states that “(c)onstruction site vehicle exit locations must be inspected for evidence of off-site sediment tracking onto paved surfaces. Tracked sediment must be removed from all paved surfaces both on and off site within 24 hours of discovery, or if applicable, within a shorter time.”

Note that Section IV.F.3 of the permit states “If the Permittee(s) wash the exterior of vehicles or equipment on the project site, washing must be limited to a defined area of the site. Runoff from the washing area must be contained in a sediment basin or other similarly effective controls and waste from the washing activity must be properly disposed of. The Permittee(s) must properly use and store soaps, detergents, or solvents. No engine degreasing is allowed on site.”

## Effectiveness

Properly installed, and maintained vehicle tracking BMPs are effective at removing mud and soil from vehicles leaving the site. The overall effectiveness can range from low (less than 30 percent soil removal) to moderate (30 to 60 percent removal) for rock pads and shaker racks, depending on the design, installation, frequency of use, and maintenance. For example, effectiveness of rock pads will decrease as rock voids become clogged with soil and mud. To prevent this, the rock must be periodically toppedressed with additional rock, replaced, or the length of the pad increased. Properly installed and operated wheel washer units are effective at removing more than 75 percent of sediment in nearly all applications. The following table summarizes expected performance for an array of typical water quantity and quality target constituents for temporary vehicle tracking BMPs.

### Expected performance for temporary vehicle tracking BMPs.

[Link to this table](#)

#### Water quantity

Flow attenuation	Little or no design benefit
Runoff volume reduction	Little or no design benefit

## **Water quantity**

### **Water quality**

Erosion prevention	Little or no design benefit
Sediment control	Primary design benefit
Nutrient loading	Secondary design benefit

### **Pollutant removal**

Total suspended solids	Primary design benefit
Total phosphorus	Secondary design benefit
Heavy metals	Secondary design benefit
Floatables	Little or no design benefit
Oil and grease	Little or no design benefit

## **Planning considerations**

When planning a vehicle tracking BMP, the following guidelines should be followed.

- Install the vehicle tracking BMP prior to any land disturbing activity.
- All construction traffic should be limited to exiting the site through these designated locations.
- Locate vehicle tracking BMPs on well drained areas if possible, such as on hilltops or upper slopes.
- Keep exit pads away from streams and wetlands if possible.
- Ensure traffic safety at exit points in addition to siting exits in well drained locations.
- Avoid siting exits at dips, low spots, and areas that stay wet or remain wet after precipitation.
- Exit pads can be set back off the roadway if there is no risk of tracking mud or debris after vehicles traverse the pad. For example, an exit pad could lead to a gravel access road connecting the site to a paved roadway, rather than immediately adjacent to the roadway.
- For most sites with a low risk of sediment tracking, a rock exit pad will suffice if it is located, installed and maintained properly.
- Sites with moderate and high-risk of sediment tracking may require a shaker rack or a wheel washer.
- Where wheel washers are used, a source of wash water is required.
- The use of a wheel washer also requires a turnout or doublewide exit to avoid entering vehicles having to drive through the wash area.
- Sediment that collects on or adjacent to the exit pad will need to be managed by a trap or other BMP, to keep it from moving off-site.
- When planning the most effective entrance/exit, the following should be taken into account:
  - Underlying soils on site – silty and clayey soils cling more readily to tires, and require longer or otherwise more effective exit pads.
  - Frequency of use – heavier traffic will wear out small, thin rock pads quickly.
  - Length and width of the entrance/exit – longer, wider pads can accommodate heavier traffic and more challenging soils (e.g., clays, silts).
  - Depth of rock – Thin rock layers do not scrape mud off tires as effectively as thicker rock pads.
  - Size and type of vehicles – tractor trailers and heavy delivery trucks require a thicker, longer exit pad than exits serving pickup trucks and automobiles.
  - Frequency of maintenance – exit pads sited in wet conditions, with clay or silt soils, and used frequently by heavy vehicles will require more frequent cleaning and maintenance than those located in well drained, sandy areas and used by light vehicles less frequently.

## **Design and construction**

In this section, design and construction guidance is provided for three designs:

- Rock/stone pad (vehicle tracking pad)
- Shaker rack
- Wheel washer/wash rack

All three designs include the planning and siting information discussed above, along with considerations for managing sediment that accumulates at the site. For most applications, the vehicle tracking BMP area can be graded to facilitate drainage toward a stabilized swale or ditch which empties into a treatment area. This treatment area can include a sediment trap, a curved section of silt fence (i.e., with the ends turned uphill to prevent bypasses), a sediment pond, or other sediment removal device. Additionally, a pipe, culvert, or water bar can be constructed as part of the BMP if needed to prevent surface water and runoff from flowing across the entrance and out onto paved roadways.

### Rock/stone pad (vehicle tracking pad)

Rock/stone pads remove material from vehicle tires through physical scraping action. Additionally, vehicle tracking pads can be installed to provide a barrier and keep the truck wheels from coming in contact with wet, sticky underlying soils. The amount of construction traffic and frequency of use should be considered when designing a vehicle tracking pad. Specific design requirements include the following:

- Exit pads constructed of rock should be of sufficient width to treat the widest vehicles.
- Pads should be a minimum 20 feet wide and 50 feet long. Longer pads should be used if needed to remove mud, soil, and rock from tires.
- The pad can be laid at grade on the exit road – excavation is not required.
- Rock used for the pad should be coarse aggregate of sufficient size to remove mud from vehicles (e.g., approximately 2 to 6 inches, depending on site conditions). Generally, the larger the aggregate, the better.
- Pad thickness should be sufficient to remove material from tires – 6 to 12 inches.
- The rock pad should be underlain with nonwoven geotextile fabric, to prevent subsidence and migration of mud from underlying soil.
- A turning radius of 20 feet should be included on each edge where the pad intersects the road.
- Design so that drainage from the pad area leads to a trap, silt fence, or other BMP for settling.

### Shaker rack

Shaker racks – also called exit grids, rumble strips, rumble racks, rumble plates, etc. – remove material from vehicle tires through bouncing and shaking action. These are appropriate when the rock pad alone is not sufficient to remove sediment from tires. Wheel washers (see below) may be necessary if rock pads and shaker racks are ineffective. Where used, shaker racks must be long enough and create enough rumble or shake to dislodge mud, soil, and rock. They can be fabricated from concrete or metal (i.e., similar to cattle guards), or acquired from construction site stormwater compliance vendors. Specific design requirements include the following:



Vehicle tracking rock pad at site entrance/exit rock. Source: Created by Tetra Tech for US EPA and State of Kentucky.



Example vehicle tracking pad. Source: City of Milwaukee.

- Shaker rack exit pads should be of sufficient width to handle the widest vehicles.
- Pads should be long enough to remove mud, soil, and rock from tires.
- Racks with less than 4 inches of soil storage space below the top of the rack should be installed over a 6 inch pad of coarse aggregate.
- Design so that drainage from the pad area leads to a trap, silt fence, or other BMP for settling.

## Wheel washer/wash rack

In many cases, the action of tires moving over the rock pad may not adequately remove sediment, and a wash rack may be required. Wheel washer systems – also called wash racks – use pressure-sprayed water to remove mud, soil, and rock from vehicles exiting the site. They can be fabricated from piping, hoses, driveway racks (e.g., concrete and metal cattle guards), and other materials, or acquired from construction site stormwater compliance vendors. Designs range from pipe units that can be hung from Jersey wall sections to wash stations that include elevated driveways above sediment trapping basins. Specific design requirements include:

- Washer spray must be directed to remove material on the inside as well as outside of wheels.
- Design so that drainage from the wheel wash area leads to a trap, silt fence, or other BMP for settling.
- Wash water migrating off the site will need to be treated to remove sediment (e.g., via a sediment trap, rock berm, or sediment pond) or recycled.
- Consider ice buildup on roadways as dripping vehicles leave the site during cold weather.

A wash rack installed on the rock pad may make washing more convenient and effective. The wash rack would consist of a heavy grating over a lowered area. The grating may be a prefabricated rack, such as a cattle guard, or it may be constructed on site of structural steel. The wash rack must be strong enough to support the vehicles that will cross it.

## Standards and specifications

MnDOT Standard Plan 5-297.405 provides standard detail for “Construction Exits” (effective date: 8/6/2014). BMPs covered include “Slash Mulch, Crushed Rock, or Sheet Pad Construction Exit” and “Rumble Pad Construction Exit” (See page 31, Standard Plan 5-297.405, 5 of 7).

MnDOT Specification 2573.3.K (Construction Exit Controls) provides guidance for exit type selection and use, and ranks exit controls from lowest to highest protection. Specification 3882 (Mulch Material) may also be applicable, depending on the exit type selected (See page 507).

## Inspection

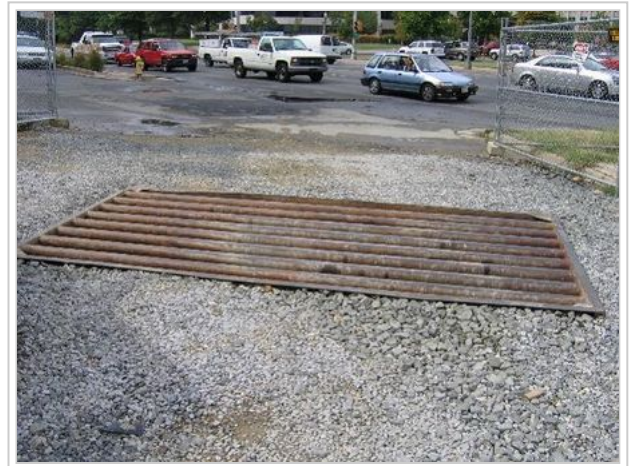

Example shaker rack installation. Source: Tetra Tech.



Example commercial wheel wash system. Source: Meeds Environmental, LLC



Vehicle tracking BMPs require continuous monitoring, especially during and after rain events and during snowmelt, due to the risks posed by mud, soil, and other debris on roadways – especially high speed urban and rural highways. Specific inspection requirements include the following.

- Check continuously for mud and soil deposits on offsite roads and other areas.
- Inspect sediment deposition area for accumulations that affect exit pad performance.
- Ensure that exit pad area has positive drainage toward treatment BMP device/area.
- Inspect exit pad drainage ditch or swale to ensure proper vegetation or other stabilization.
- Inspect downgradient sediment treatment BMP to ensure ongoing effectiveness.
- During cold weather, monitor any drip-induced ice buildup on offsite paved surfaces.

## **Maintenance**

If site inspection(s) reveal concerns, maintenance will be necessary. Maintenance of vehicle tracking BMPs includes the following:

- Immediately remove mud, soil, and other debris from offsite areas – particularly roadways.
- Remove sediment that accumulates in the pad area, ditch/swale, or nearby stormwater facilities if performance is affected.
- Revegetate or otherwise stabilize eroding ditches, swales, or traps/basins treating exit pad runoff.
- Adjust the vehicle tracking BMPs to ensure proper functioning if performance is poor, including the following:
  - Clean or add rock – including larger rock, or extend the length of rock pads.
  - Regrade rock as needed to ensure positive drainage.
  - Extend the length of shaker racks; ensure drivers use enough speed to dislodge debris.

Maintenance of wheel washers/wash racks includes the following:

- Ensure wash water drainage, collection, and treatment systems are functioning.
- The wash water collection area should be regularly cleaned out to ensure sediment is contained properly.
- Remove/discharge wash water as needed.
- Maintain a clean run-out pad.
- Adjust wheel washer nozzle direction and spray pressure, and add nozzles as needed.

Cold weather considerations include the following:

- As with summer months, additional rock/aggregate should be readily available for top dressing and maintenance of the pad throughout winter.
- Construction sites should maintain a functioning vehicle tracking BMPs during the winter even if no construction activities are taking place.
- Use salt or sand if ice accumulates on roadways due to dripping caused by wheel washer.
- Plowing and street sweeping may be needed to ensure mud does not remain on roadways.
- Promptly remove sediment and sediment laden snow and ice on roadways prior to spring melt.

## **Costs**

The following estimated BMP cost is based on MnDOT data summarizing average bid prices for awarded projects in 2014.

- Bid item 2573.535/00010, stabilized construction exit - \$5,763.08

## **Reference materials**

Except where more stringent requirements are presented in this guidance, vehicle tracking BMPs shall comply with MnDOT and other state requirements. Primary design references include:

- MnDOT Erosion Control Handbook II
- Minnesota Urban Small Sites Best Management Practice Manual (Vehicle Tracking Pad)
- 2013 Minnesota NPDES/SDS Construction Stormwater General Permit
- MnDOT Standard Specifications for Construction (2016 Edition)
- MnDOT Standard Drawings for use in Construction Plans

The following is a list of additional resources that are not specific to Minnesota:

- Clean Water Services Erosion Prevention and Sediment Control Manual (4.2.2 Construction Entrance, 4.2.13 Tire Wash Facility)
- North Carolina Erosion and Sediment Control Planning and Design Manual (6.06 Temporary Gravel Construction Entrance/Exit)
- Tennessee Department of Environment and Conservation (TDEC) Erosion and Sediment Control Handbook (7.28 Construction Exit, 7.29 Tire washing facility)
- Virginia Erosion and Sediment Control Handbook (3.02 Temporary Stone Construction Entrance)
- Clark County Washington Stormwater Manual (BMP C105: Stabilized Construction Entrance/Exit, BMP C106: Wheel Wash)
- Best Management Practices (BMPs) for Controlling Erosion, Sediment, and Pollutant Runoff from Construction Sites. University of Kentucky, 2009
- Delaware Erosion and Sediment Control Handbook. 2003

## Related pages

- Stabilization practices
  - Erosion prevention practices - temporary seeding and stabilization
  - Erosion prevention practices - natural and synthetic mulches
  - Erosion prevention practices - tackifiers and soil stabilizers
  - Erosion prevention practices - erosion control blankets and anchoring devices
  - Erosion prevention practices - turf reinforcement mats
- Sediment control practices
  - **Sediment control practices - Vehicle tracking BMPs**
  - Sediment control practices - Perimeter controls for disturbed areas
  - Sediment control practices - Check dams (ditch checks, ditch dikes)
  - Sediment control practices - Diversion barrier controls (cofferdams/temporary dikes)
  - Sediment control practices - Storm drain inlet protection
  - Sediment control practices - Outlet energy dissipation
- General principles for erosion prevention and sediment control at construction sites in Minnesota
- Construction stormwater photo gallery

Retrieved from "[https://stormwater.pca.state.mn.us/index.php?title=Sediment\\_control\\_practices\\_-\\_Vehicle\\_tracking\\_BMPs&oldid=30218](https://stormwater.pca.state.mn.us/index.php?title=Sediment_control_practices_-_Vehicle_tracking_BMPs&oldid=30218)"

Category: Table

This page was last modified on 9 November 2016, at 15:56.

**Minnesota Pollution Control Agency** | 651-296-6300, 800-657-3864 | Assistance | Web site policy

© 2016 by Minnesota Pollution Control Agency • Powered by MediaWiki